

E.M. "PADRE ELÍDIO MANTOVANI"

APOSTILA 5



ALUNO: _____

1º ANO B PROFESSORA ELIANA

ATIVIDADES DE 11/05/21 A 31/05/2021

RETIRADA DIA 11/05/2021
DEVOLUÇÃO DIA 08/06/2021

Oriente bem os pequenos na tarefa escolar

Como nossas crianças ainda não conseguem ler, é muito importante que os ajude quanto à realização das tarefas. Todos os dias é enviado um vídeo explicativo e em caso de dificuldade, os pais precisam comunicar à professora, assim podemos trabalhar em parceria nesse momento atípico que estamos enfrentando.

Criar uma rotina para que o aluno realize as atividades também pode ajudar muito. Sabemos que a rotina varia de uma família para outra, mas dentro do dia achar um horário fixo para esse momento, o que traz segurança e cria o hábito, que deixa tudo mais fácil e prazeroso.

É importante que os vídeos explicativos sejam mostrados para o aluno, pois é com ele que se inicia a proposta pedagógica.

Aos poucos, a criança vai desenvolvendo a responsabilidade, percebendo que a tarefa pode se tornar um momento agradável e prazeroso, além de perceber que, através dela, é possível compreender melhor os conteúdos trabalhados na escola, tornando seu aprendizado mais consistente.

**Qualquer dúvida estou à disposição!
Prof.^a Eliana**









ESCOLA MUNICIPAL "PADRE ELÍDIO MANTOVANI"

NOME:

IBIÚNA, 11 DE MAIO DE 2021

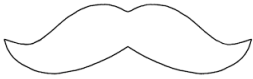
VAMOS DESCOBRIR QUANTOS PEDAÇOS TEM AS PALAVRAS:

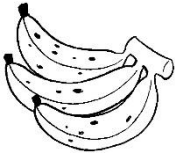
- PARA ESSA ATIVIDADE PEÇA PARA A MAMÃE UM POUCO DE FEIJÃO,
 - VEJA O VÍDEO EXPLICATIVO E VAMOS FAZER A ATIVIDADE:
1. CADA VEZ QUE ABRIR A BOCA PEGA UM FEIJÃO, DEPOIS CONTE QUANTOS PEGOU E COLOQUE NA FRENTE DA PALAVRA O NÚMERO.





IMAGEM	PALAVRA	FEIJÕES	QUANTIDADE
	BOLO		
	BALA		
	BULE		
	BICICLETA		
	BIGODE		
	BEXIGA		
	BANANA		
	BODE		





ESCOLA MUNICIPAL "PADRE ELÍDIO MANTOVANI"

NOME:

IBIÚNA, 11 DE MAIO DE 2021

1. DESCUBRA QUE NÚMERO DEVERIA ESTAR NO LUGAR DOS SÍMBOLOS:

0	1	2		4		6	7	8	
10	11		13		15	16	17	18	19

NOME:

IBIÚNA, 12 DE MAIO DE 2021

SILABÁRIO

UNA A LETRA B COM CADA VOGAL E FORME AS SÍLABAS:

Diagram illustrating the formation of syllables using the letter **B** and vowels:

- B** + **A** → **BA**
- B** + **E** → **BE**
- B** + **I** → **BI**
- B** + **O** → **BO**
- B** + **U** → **BU**

NOME:

IBIÚNA, 12 DE MAIO DE 2021

CONTE E REGISTRE

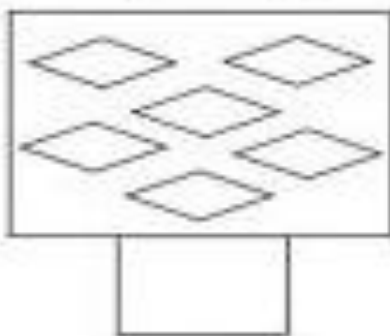
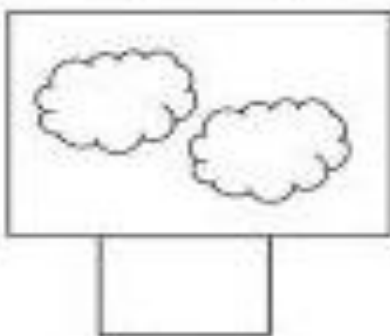
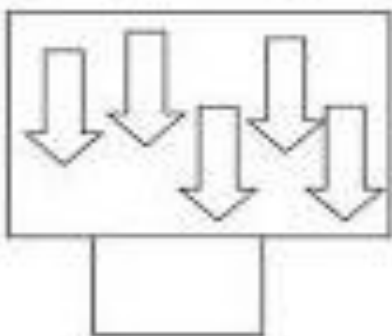
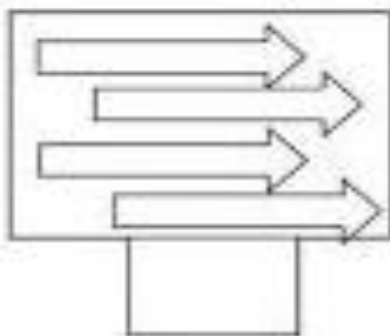
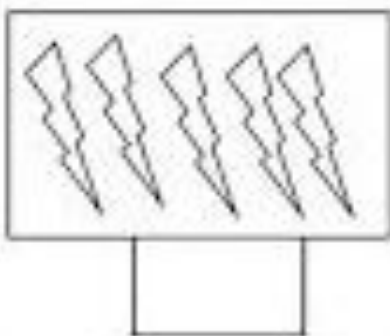
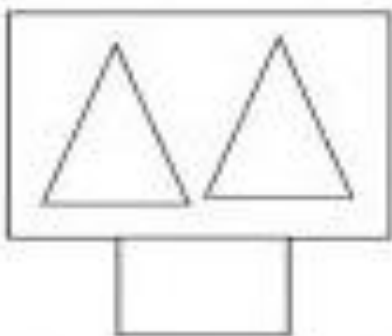
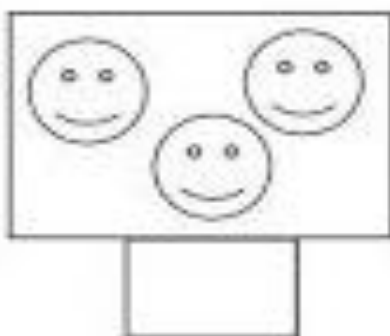
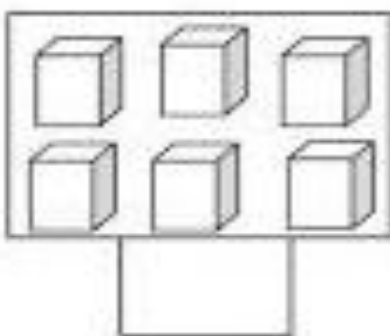
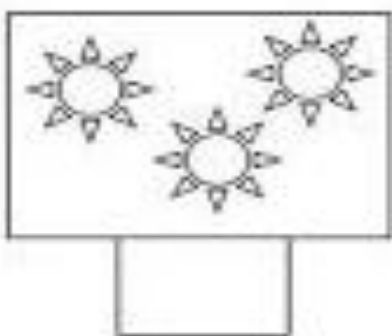
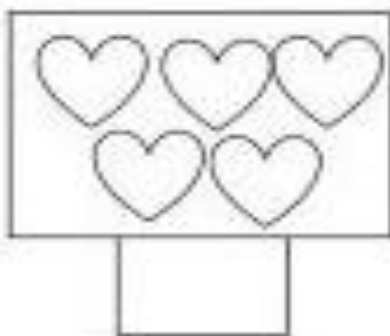
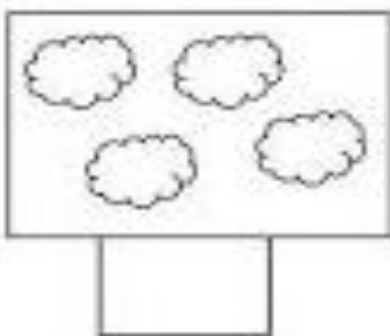
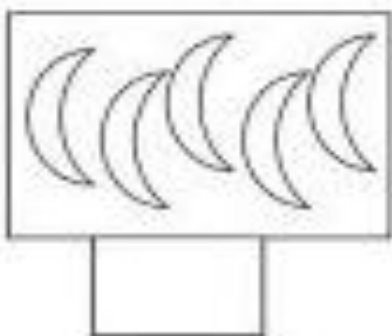

NOME:

IBIÚNA, 13 DE MAIO DE 2021

- **VAMOS OUVIR ESSA HISTÓRIA EM FAMÍLIA:**

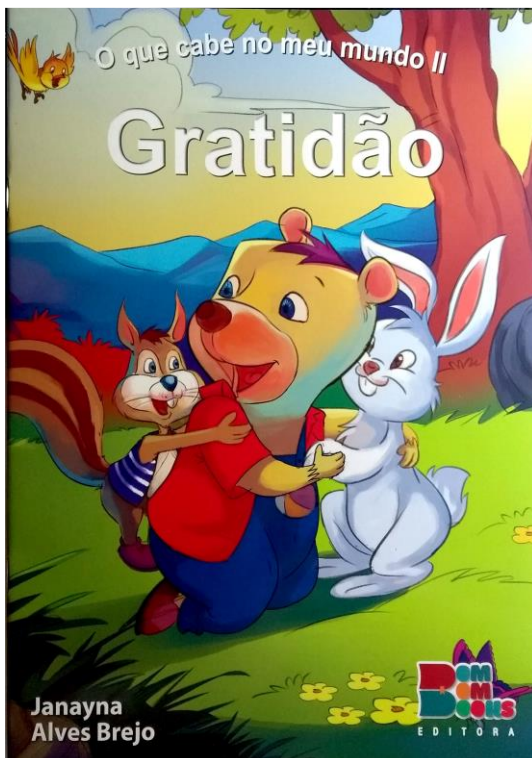

- **AGORA QUE OUVIMOS CONVERSE COM SEUS PAIS PELO O QUE VOCÊ É GRATOS HOJE?**
 - **DEPOIS ALGUÉM VAI ESCREVER SUA RESPOSTA AQUI:**

NOME:

IBIÚNA, 13 DE MAIO DE 2021

TRABALHANDO OS SENTIDOS

 **LIGUE DE ACORDO:**

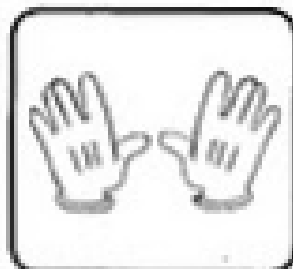
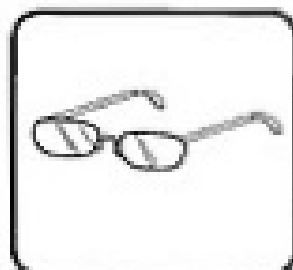
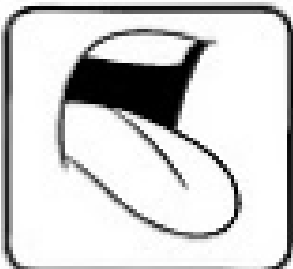
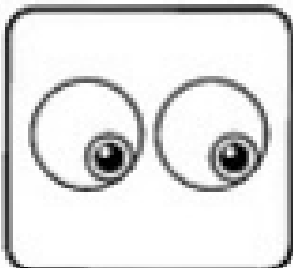

<https://images.app.goo.gl/hME7jSSprVj9uXcp6>

NOME:

IBIÚNA, 14 DE MAIO DE 2021

ATIVIDADE



QUAL NÚMERO VEM DEPOIS?

□ 6 □ 8 □ 5 □ 7 □ 3 □

ESCREVA NA ORDEM CRESCENTE.

0 □ □ □ □ □ □ □ □

VAMOS SOMAR?

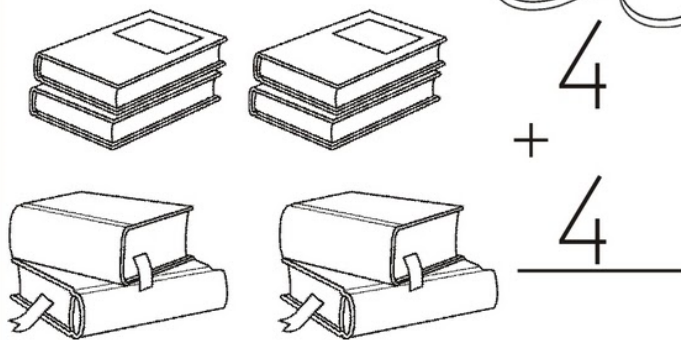
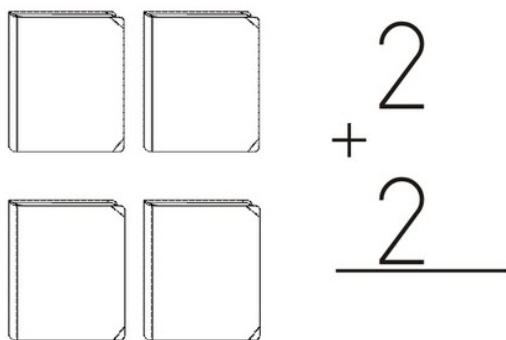
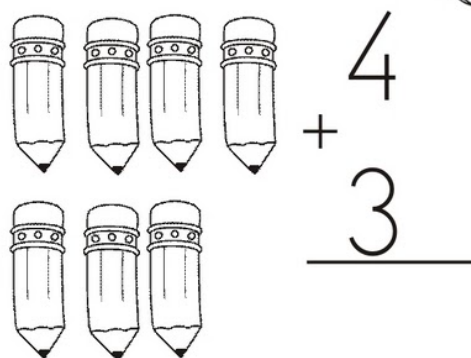
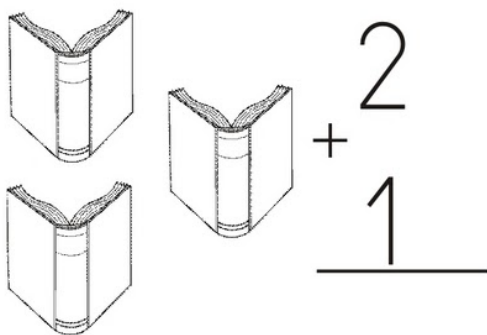

NOME:

IBIÚNA, 14 DE MAIO DE 2021

1. QUAL SÍLABA ESTÁ FALTANDO?

	A		JUR
---	----------	--	------------

	CA	RAM		LA
---	-----------	------------	--	-----------

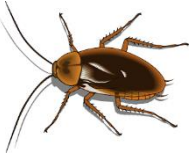
		RA	TA
--	--	-----------	-----------

	BAM		LÊ
---	------------	--	-----------

	BAR		A	DOR
---	------------	--	----------	------------

	POM	
---	------------	--

	A		LHA
---	----------	--	------------

NOME:

IBIÚNA, 17 DE MAIO DE 2021

- LIGUE OS PONTOS E DESCUBA QUE ANIMAL SE FORMA

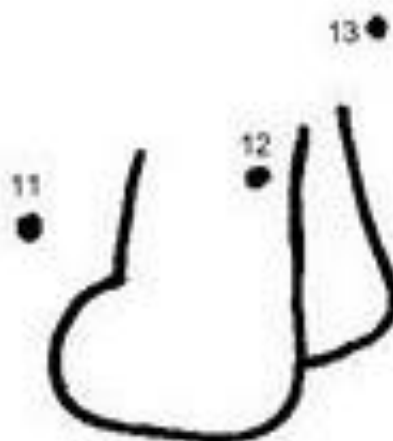

NOME:

IBIÚNA, 17 DE MAIO DE 2021

DEPOIS DE ESCUTAR A HISTÓRIA A FAMÍLIA DE MARCELO, MONTE A SUA ÁRVORE GENEALÓGICA:

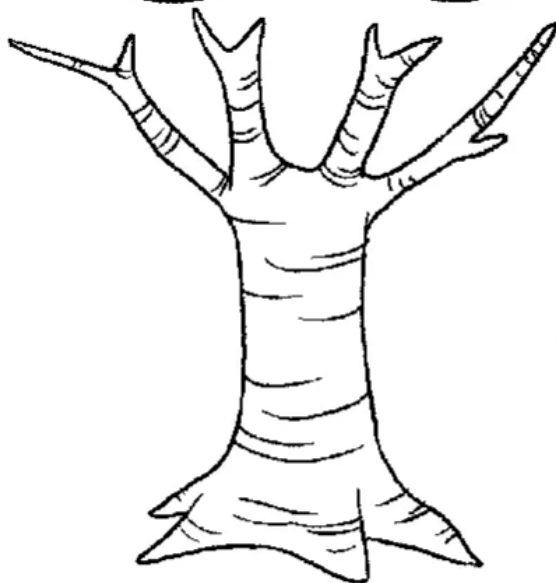
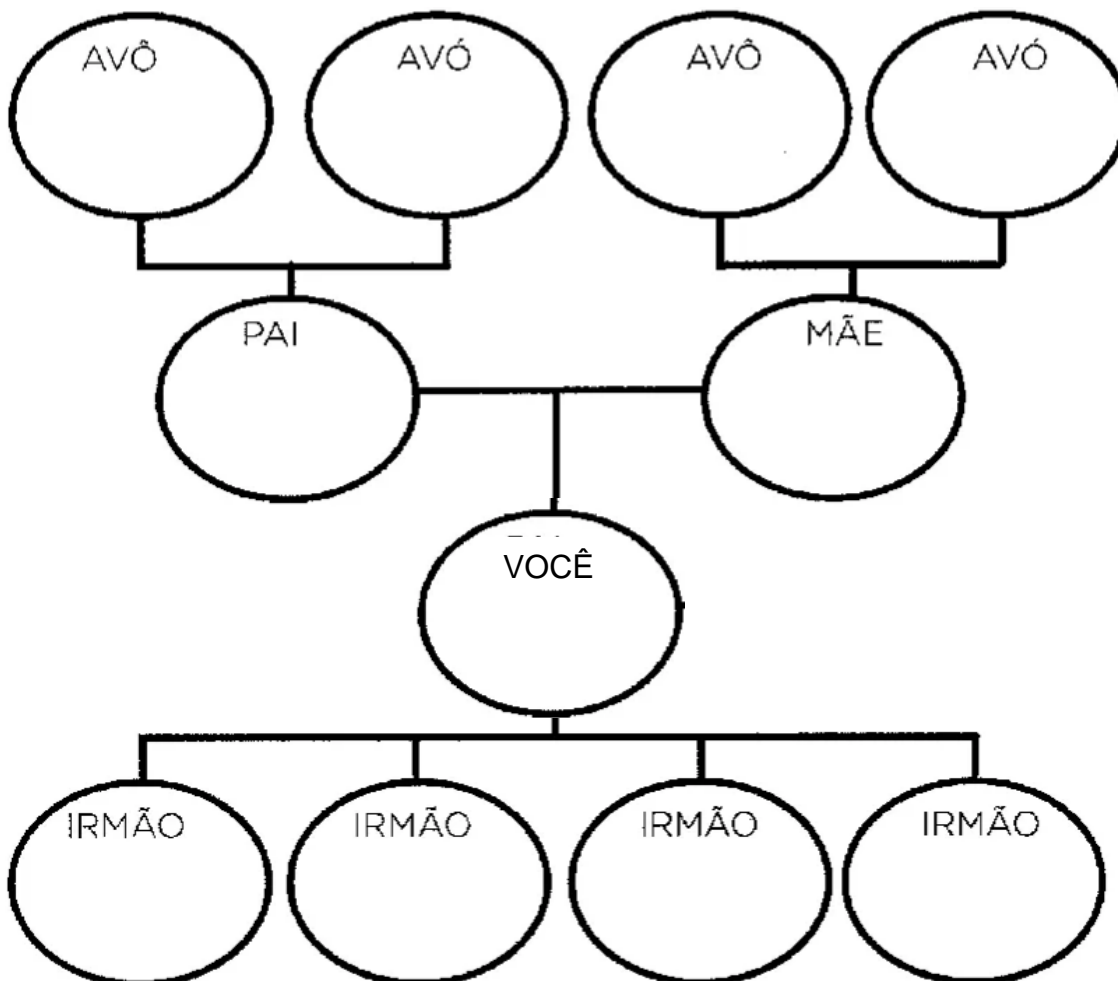

ESSA É
A MINHA
FAMÍLIA!

NOME:

IBIÚNA, 18 DE MAIO DE 2021

1. VAMOS LER JUNTOS ESSE TRAVA LÍNGUAS:
2. DEPOIS CIRCULE TODAS AS SÍLABAS DA FAMÍLIA DO **B**.

A BOTA DO BETO

NA BOTA DE BETO
A BOLA BATEU.
BETO BOTOU
BANCA DE BRAVO.
BUFANDO, BERROU
EM ALTOS BRADOS:
_ PARA O BOBO DO BODE
QUE MANDOU ESTA BOLADA
EU JÁ BOLEI BOAS BUTINADAS.



NOME:

IBIÚNA, 19 DE MAIO DE 2021

- VAMOS OUVIR ESSA HISTÓRIA EM FAMÍLIA:



- AGORA QUE OUVIMOS CONVERSE COM SEUS PAIS O QUE VOCÊ GOSTA DE FAZER COM DEDICAÇÃO?
 - DEPOIS ALGUÉM VAI ESCREVER SUA RESPOSTA AQUI:

NOME:

IBIÚNA, 19 DE MAIO DE 2021

- RECORTE E COLE PARA COMPLETAR A PARLENDAS:

HOJE É DOMINGO...

HOJE É DOMINGO
PEDE _____.



O CACHIMBO É DE BARRO
BATE NO _____.

O JARRO É FINO
BATE NO _____



O SINO É DE OURO
BATE NO _____.

O TOURO É VALENTE
BATE NA _____.



A GENTE É FRACO
CAI NO _____.

O BURACO É FUNDO
ACABOU-SE O _____



<https://images.app.goo.gl/FbH8HpN523qQiVup8>



CACHIMBO

JARRO

SINO

TOURO

GENTE

BURACO

MUNDO

NOME:

IBIÚNA, 20 DE MAIO DE 2021

- VAMOS MONTAR O JOGO DA MEMÓRIA E JOGAR COM TODA FAMÍLIA:
- RECORTE, EMBARALHE COM AS IMAGENS VIRADA PARA BAIXO,
- AGORA É SÓ ENCONTRAR O PAR CERTO.

BOA DIVERSÃO

A brincadeira constitui um incentivo ao desenvolvimento de novas habilidades e à busca de novas explicações, pois, para as crianças, é sempre mais agradável trabalhar sobre situações imaginárias e hipotéticas, seguindo determinadas regras.

Os jogos e as brincadeiras são fontes de felicidade e prazer que se fundamentam no exercício da liberdade e, por isso, representam a conquista de quem pode sonhar, sentir, decidir, arquitetar, aventurar e agir, com energia para superar os desafios da brincadeira, recriando o tempo, o lugar e os objetos.

<https://images.app.goo.gl/kqRzG46RUo7sT7Bp8>

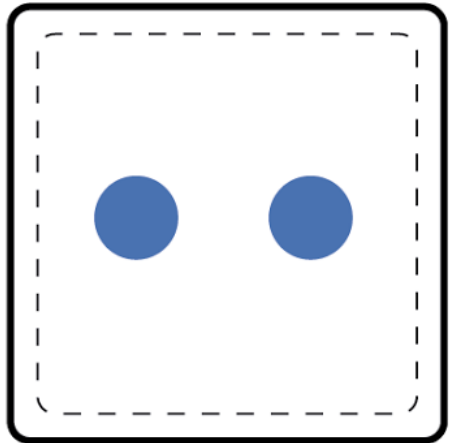
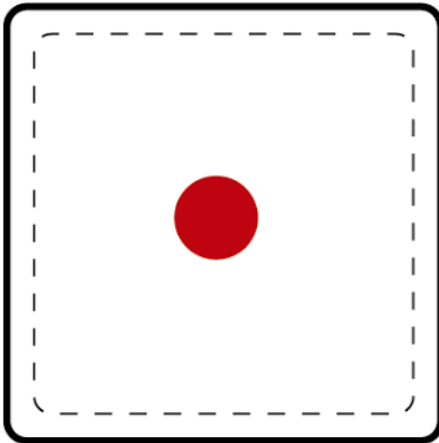
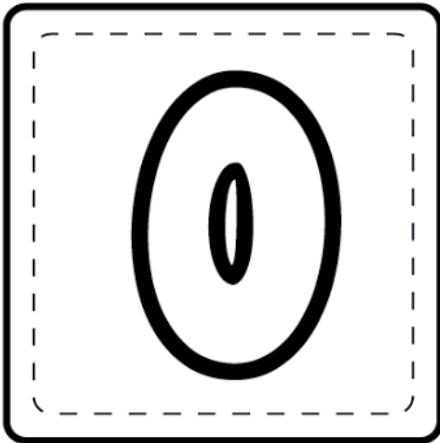
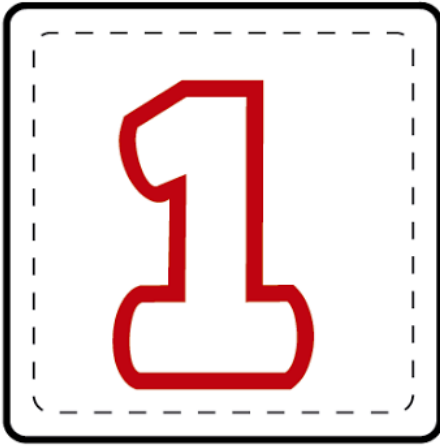

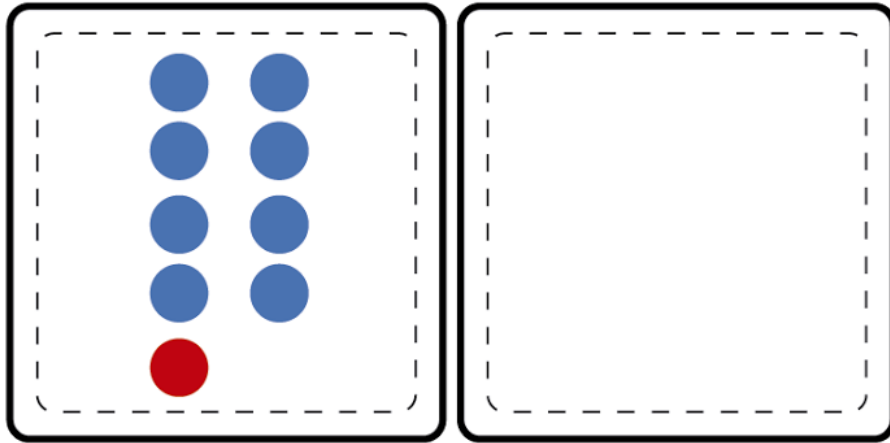
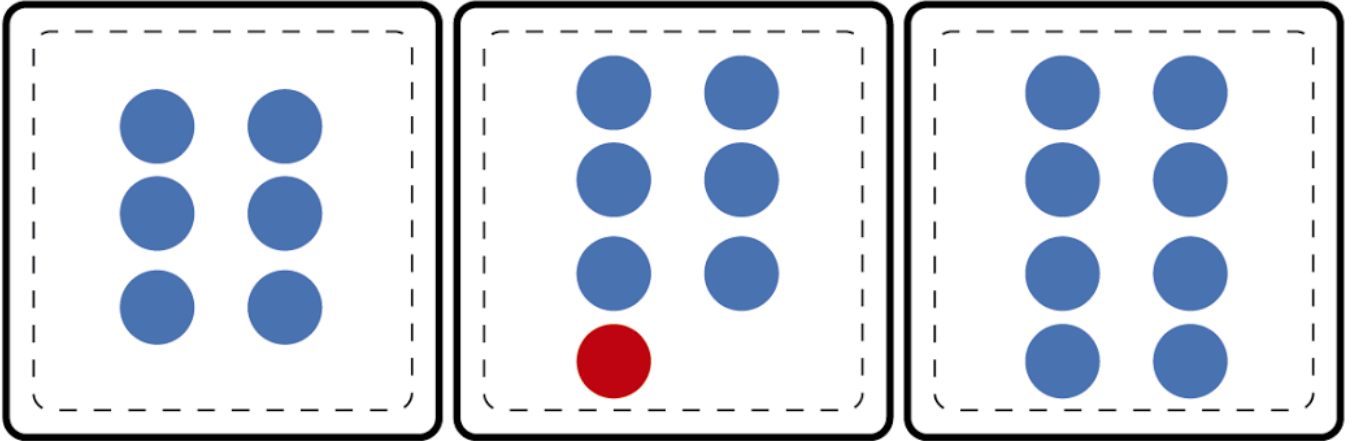
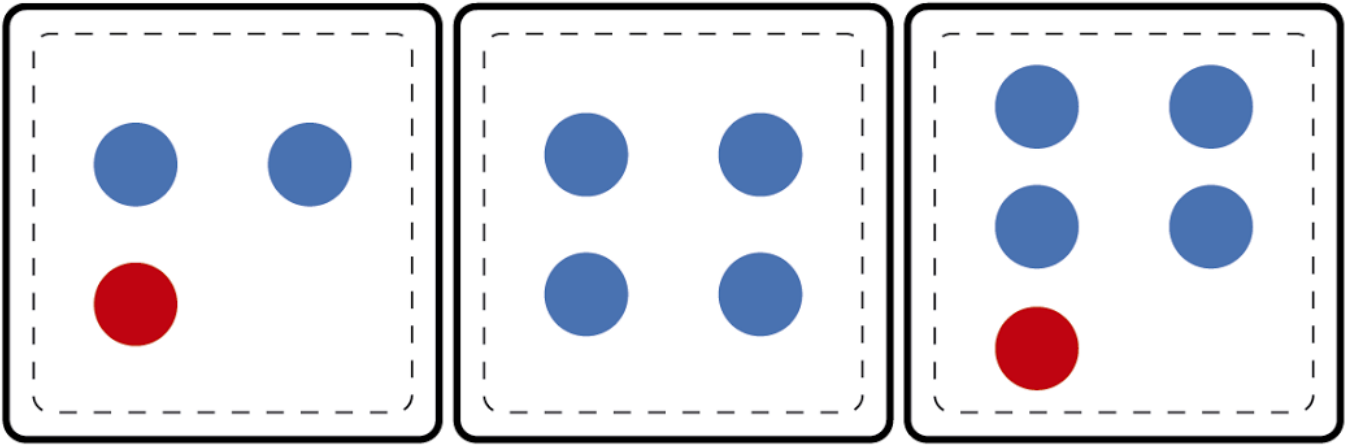

NOME:

IBIÚNA, 20 DE MAIO DE 2021

FAMÍLIA SILÁBICA

D

UNA A LETRA D COM CADA VOGAL E FORME AS SÍLABAS:

The diagram illustrates the formation of syllables using the letter 'D' and five vowels. On the left, a blue-outlined 'D' in a rounded square has five arrows pointing to the right. Each arrow points to a red-outlined vowel in a rounded square: 'A', 'E', 'I', 'O', and 'U'. To the right of each vowel is a rounded rectangle containing a dashed outline of the syllable formed by the 'D' and the vowel: 'DA', 'DE', 'DI', 'DO', and 'DU'.

<https://images.app.goo.gl/BLiYVK4a6A2iqdAQ6>

NOME:

IBIÚNA, 21 DE MAIO DE 2021



JOGANDO DADOS

1) SOME O NÚMERO DE BOLINHAS DOS DADOS E DESCUBRA QUANTOS PONTOS CAROLINE FEZ CADA VEZ QUE JOGOU OS DADOS. DEPOIS, LIGUE OS DADOS ÀS RESPOSTAS.

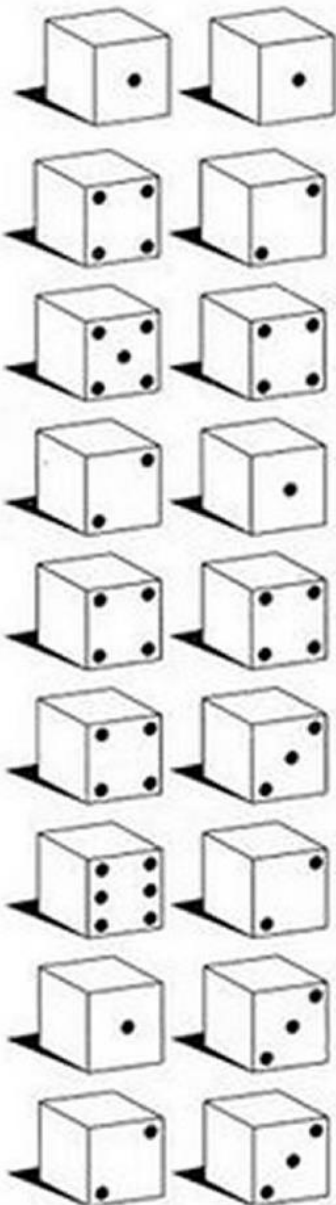

6

2

7

8

3

5

9

4

<https://images.app.goo.gl/xbraX3ensCfihodBA>

NOME:

IBIÚNA, 21 DE MAIO DE 2021

LIGUE:

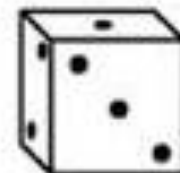
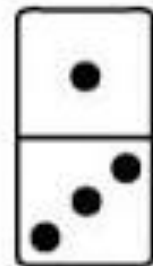

<https://images.app.goo.gl/DdHuQuXuoYrmioKj6>

NOME:

IBIÚNA, 24 DE MAIO DE 2021

2. QUAL SÍLABA ESTÁ FALTANDO?

	CA		A	
---	-----------	--	----------	--

	DE	
---	-----------	--

	BO	
--	-----------	--

	PA		RI	A
---	-----------	--	-----------	----------

	MA	CHA	
---	-----------	------------	--

	MO	E	
---	-----------	----------	--

		A	MAN	TE
---	--	----------	------------	-----------

NOME:

IBIÚNA, 24 DE MAIO DE 2021

PINTE SEGUINDO AS CORES



1- AMARELO 2- AZUL 3- VERDE 4- VERMELHO
5- LARANJA 6- VIOLETA 7- MARRON

<https://images.app.goo.gl/HngLE3CFMjnpusz9>

NOME:

IBIÚNA, 25 DE MAIO DE 2021

- QUE LETRA FALTA PARA COMPLETAR AS PALAVRAS



URU ___ U

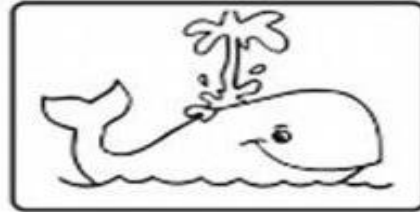

___ ALEIA

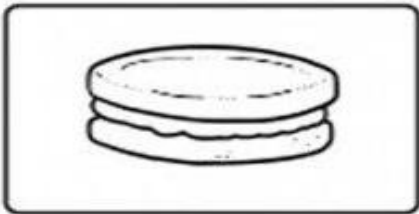

___ ISCOITO



A ___ Ó ___ ORA



A ___ ACAXI

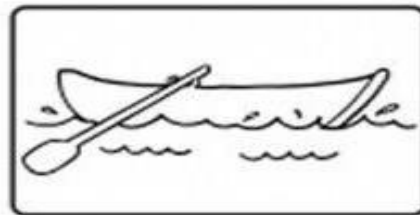

___ ARCO

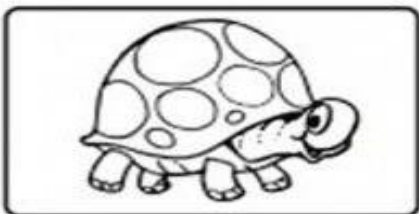

JA ___ UTI



___ OR ___ OLETA

ESCOLA MUNICIPAL "PADRE ELÍDIO MANTOVANI"

NOME:

IBIÚNA, 25 DE MAIO DE 2021

CONTE AS FIGURAS E COLOQUE O NUMERAL

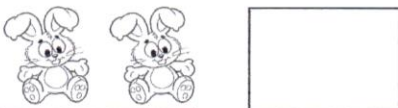
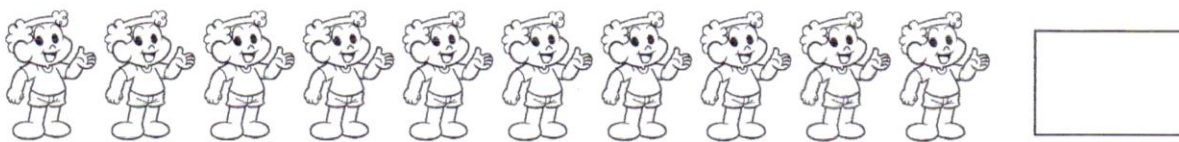

MIDIAMM

<https://images.app.goo.gl/skaBDFD9SL2LXKzi7>

NOME:

IBIÚNA, 26 DE MAIO DE 2021

- **VAMOS OUVIR ESSA HISTÓRIA EM FAMÍLIA:**



- **AGORA QUE OUVIMOS CONVERSE COM SEUS PAIS NO QUE VOCÊ TEM OTIMISMO?**
 - **DEPOIS ALGUÉM VAI ESCREVER SUA RESPOSTA AQUI:**

NOME:

IBIÚNA, 26 DE MAIO DE 2021

I. VAMOS EFETUAR CÁLCULO MENTAL?

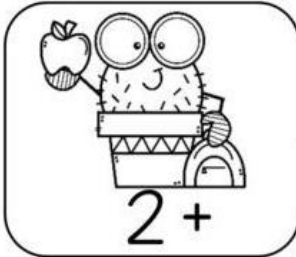

2	1	5	6	8

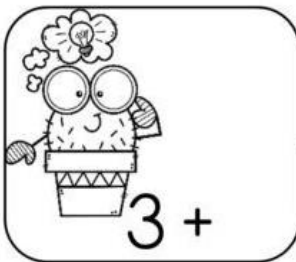

1	2	4	3	6

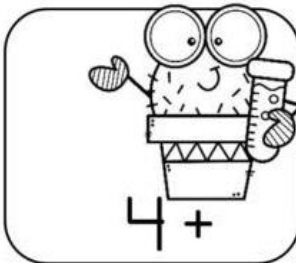

3	1	5	2	0

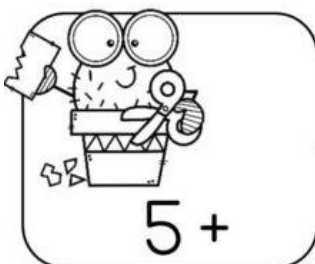

0	4	3	1	5

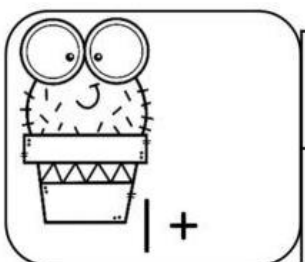

1	6	8	4	2

<https://images.app.goo.gl/YxBCnbn1NZ1w3KcJA>

NOME:

IBIÚNA, 27 DE MAIO DE 2021

- QUE LETRA FALTA PARA COMPLETAR AS PALAVRAS



___ INOSSAURO

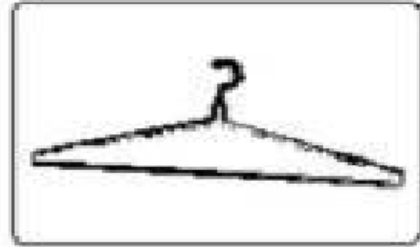

CABI ___ E

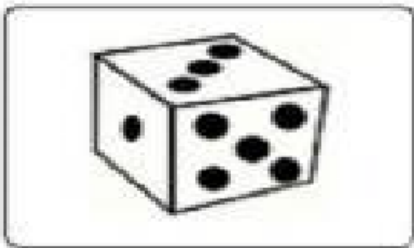

___ A ___ O



BO ___ E



CA ___ EA ___ O

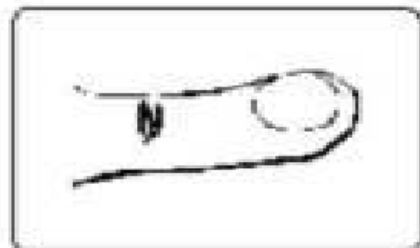

___ E ___ O



___ ENTE

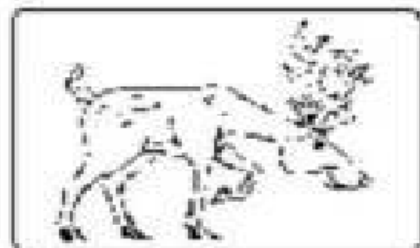

VEA ___ O

NOME:

IBIÚNA, 27 DE MAIO DE 2021

CIRCULE O NÚMERO QUE ESTÁ NO LUGAR ERRADO:



0	1	2	3	4	5	6	3	8	9
---	---	---	---	---	---	---	---	---	---



10	11	12	13	24	15	16	17	18	19
----	----	----	----	----	----	----	----	----	----



20	21	22	23	24	25	26	27	82	29
----	----	----	----	----	----	----	----	----	----

NOME:

IBIÚNA, 28 DE MAIO DE 2021

1. LIGUE AS IMAGENS AS SÍLABAS INICIAIS

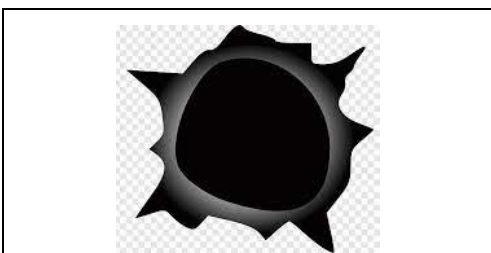
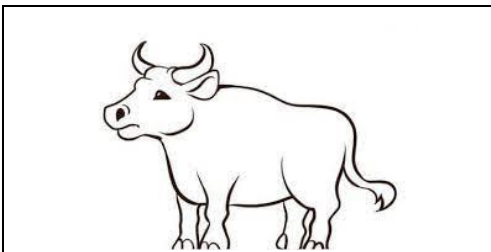
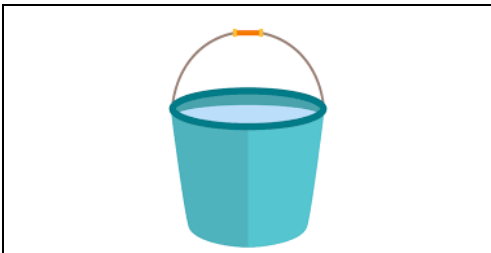
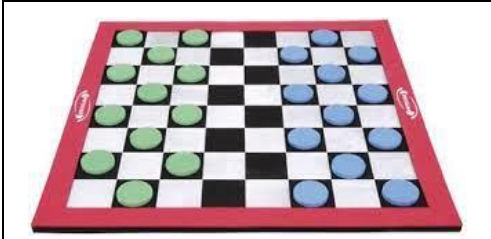

DU

BO

DO

BA

DA

BU

NOME:

IBIÚNA, 28 DE MAIO DE 2021

- OBSERVE A RETA NUMÉRICA

1 2 3 4 5 6 7 8 9 10

- ESCREVA OS VIZINHOS DE CADA NÚMERO ABAIXO:

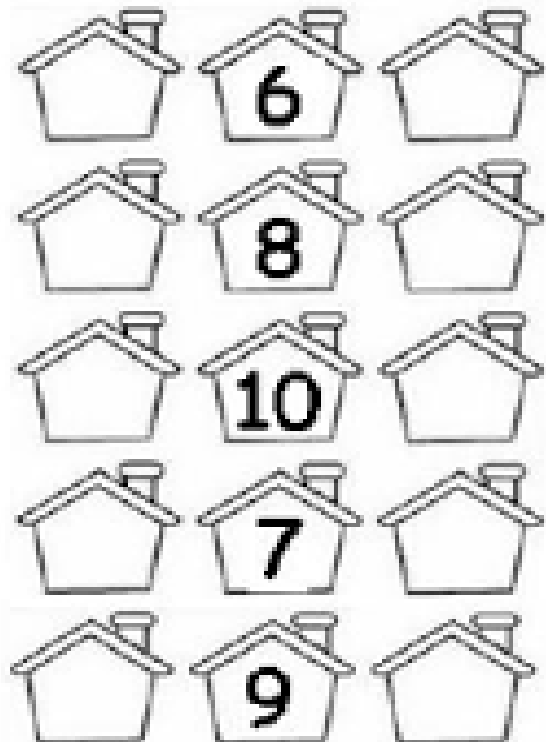
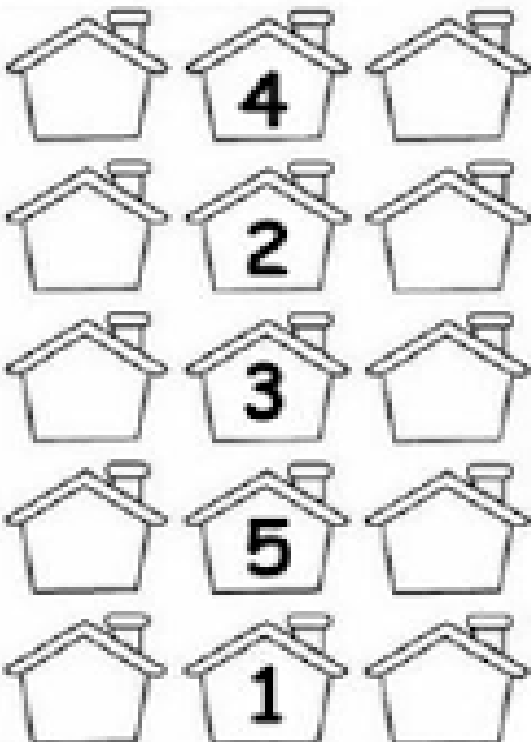

- CONTINUE A SEQUÊNCIA



NOME:

IBIÚNA, 31 DE MAIO DE 2021

FAMÍLIA SILÁBICA

L

UNA A LETRA L COM CADA VOGAL E FORME AS SÍLABAS:







The diagram illustrates the formation of syllables using the letter 'L' and five vowels. On the left, a blue-outlined 'L' is shown in a rounded square. Five arrows point from this 'L' to five red-outlined vowels, each also in a rounded square: 'A', 'E', 'I', 'O', and 'U'. From each vowel, an arrow points to a rounded rectangle containing a dashed outline of the corresponding syllable: 'LA', 'LE', 'LI', 'LO', and 'LU'.

<https://images.app.goo.gl/8kMnqsj5dVTcN3Vv7>

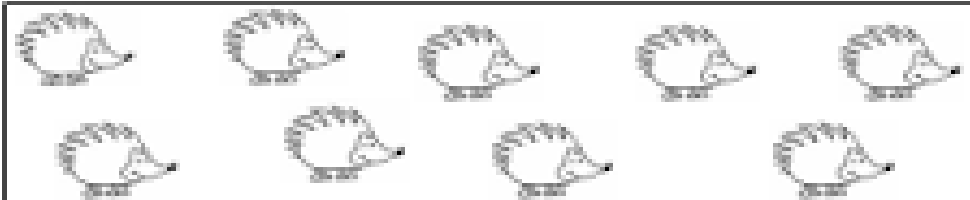
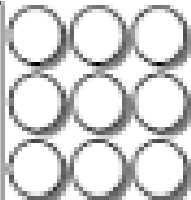
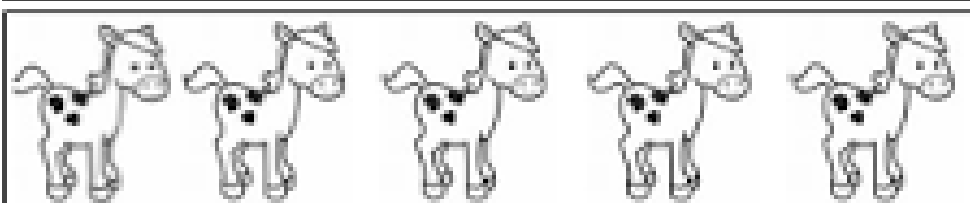
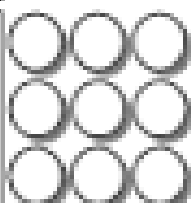
NOME:

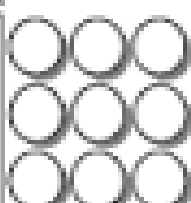
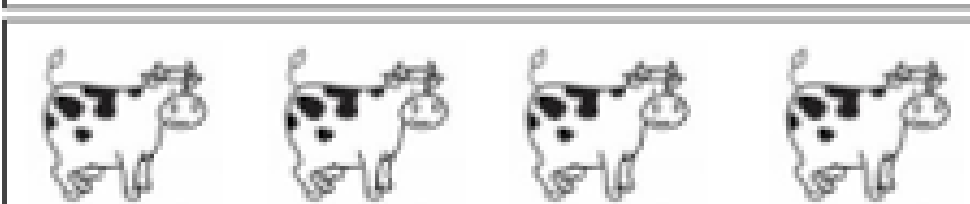
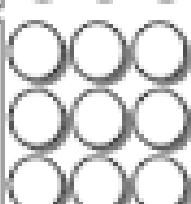
IBIÚNA, 31 DE MAIO DE 2021

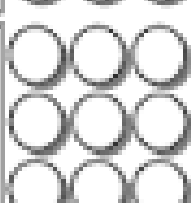
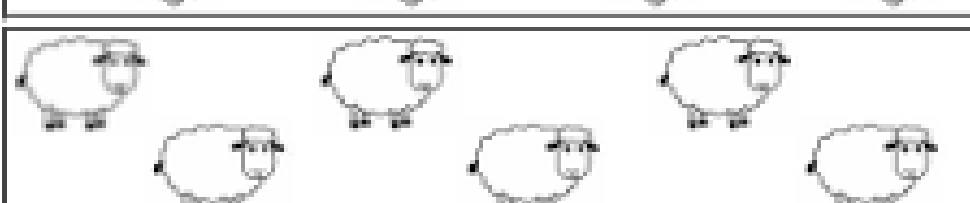
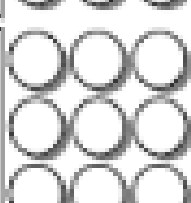
1. COLORIR OS CÍRCULOS DE ACORDO COM O NÚMERO DE ELEMENTO DE CADA CONJUNTO E ESCREVER O NÚMERO QUE OS REPRESENTA:

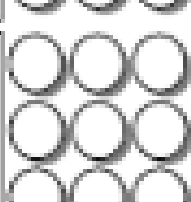
		<input type="text"/>
		<input type="text"/>
		<input type="text"/>
		<input type="text"/>
		<input type="text"/>
		<input type="text"/>
		<input type="text"/>

<https://images.app.goo.gl/rjsJwriskUJcneqAA>