

E.M. “PADRE ELÍDIO MANTOVANI”



NOME: _____

1º ANO A PROFESSORA JANE

ATIVIDADES DE 05/07/21 À 06/08/2021

DEVOLUÇÃO: 10/08/2021

NOME:

IBIÚNA, _____ DE JULHO DE _____

05/07/2021

SABEMOS QUE O CALENDÁRIO MARCA OS DIAS DA SEMANA

PREENCHA O CALENDÁRIO COM DIAS DESTE MÊS

ANO: MÊS:

| DOMINGO | SEGUNDA- -FEIRA | TERÇA- -FEIRA | QUARTA- -FEIRA | QUINTA- -FEIRA | SEXTA- -FEIRA | SÁBADO |
|---------|--------------------|------------------|-------------------|-------------------|------------------|--------|
| | | | | | | |
| | | | | | | |
| | | | | | | |
| | | | | | | |
| | | | | | | |
| | | | | | | |

QUE DIA DO MÊS É HOJE?

QUANOS DIAS TEM ESSE MÊS?



PINTE DE VERDE O QUADRINHO DO DIA DE HOJE.

MESES DO ANO

- AJUDE O CHICO A RESPONDER!

AO TODO SOMOS DOZE
DE TEMPO FORMADOS
COM 30 OU 31

PASSAMOS LOGO AFOBADOS!

NÓS SOMOS



- O ANO TEM MESES.

LEIA O RETÂNGULO COM OS MESES DO ANO E RESOLVA DE ACORDO.

JANEIRO – FEVEREIRO – MARÇO - ABRIL –
MAIO – JUNHO – JULHO – AGOSTO – SETEMBRO
– OUTUBRO – NOVEMBRO – DEZEMBRO



O ANO COMEÇA COM O MÊS DE

É O ÚLTIMO MÊS DO ANO.

NOME:

IBIÚNA, _____ DE JULHO DE _____

06/07/2021

DE ACORDO COM O CALENDÁRIO, RESPONDA AS PERGUNTAS.

A) QUE DIA DA SEMANA É HOJE?

| | | | |
|---------|---------|--------|--------|
| DOMINGO | SEGUNDA | TERÇA | QUARTA |
| QUINTA | SEXTA | SÁBADO | |



B) QUE DIA DO MÊS É HOJE?

| | | | | | | | | | |
|----|----|----|----|----|----|----|----|----|----|
| 1 | 2 | 3 | 4 | 5 | 6 | 7 | 8 | 9 | 10 |
| 11 | 12 | 13 | 14 | 15 | 16 | 17 | 18 | 19 | 20 |
| 21 | 22 | 23 | 24 | 25 | 26 | 27 | 28 | 29 | 30 |
| 31 | | | | | | | | | |



C) QUAL É O MÊS DO ANO QUE COMEMORA O NATAL?

| | | | |
|-----------|-------|----------|----------|
| JANEIRO | ABRIL | JULHO | OUTUBRO |
| FEVEREIRO | MAIO | AGOSTO | NOVEMBRO |
| MARÇO | JUNHO | SETEMBRO | DEZEMBRO |

D) AGORA ANOTE O DIA, MÊS E ANO DA DATA DE HOJE

_____ DE _____ DE _____

JOGOS OLÍMPICOS

A QUATRO ANOS, ATLETAS DE CENTENAS DE PAÍSES SE REÚNEM NUM PAÍS SEDE PARA DISPUTAREM UM CONJUNTO DE MODALIDADES ESPORTIVAS. A PRÓPRIA BANDEIRA OLÍMPICA REPRESENTA ESSA UNIÃO DE POVOS E RAÇAS, POIS É FORMADA POR CINCO ANÉIS ENTRELACADOS, REPRESENTANDO OS CINCO CONTINENTES E SUAS CORES. A PAZ, A AMIZADE E O BOM RELACIONAMENTO ENTRE OS POVOS SÃO OS PRINCÍPIOS DOS JOGOS OLÍMPICOS.

ORIGEM DOS JOGOS OLÍMPICOS

FORAM OS GREGOS QUE CRIARAM OS JOGOS OLÍMPICOS. POR VOLTA DE 2500 A.C. OS GREGOS JÁ FAZIAM HOMENAGENS AOS DEUSES. PRINCIPALMENTE ZEUS, COM REALIZAÇÃO DE COMPETIÇÕES. PORÉM, FOI SOMENTE EM 776 A.C QUE OCORRERAM PELA PRIMEIRA VEZ OS JOGOS OLÍMPICOS, DE FORMA ORGANIZADA E COM PARTICIPAÇÃO DE ATLETAS DE VÁRIAS CIDADES-ESTADO.

JOGOS OLÍMPICOS DE TÓQUIO

A EDIÇÃO DE 2020 FOI ADIADA PARA O ANO DE 2021, POR CONTA DA PANDEMIA DE CORONAVÍRUS. OS JOGOS ACONTECERÃO EM TÓQUIO, NO JAPÃO, DE 23 DE JULHO À 08 DE AGOSTO. MIRAITOWA É A MASCOTE OFICIAL DOS JOGOS OLÍMPICOS DE TÓQUIO E SOMEITY É A MASCOTE OFICIAL DOS JOGOS PARALÍMPICOS.



MIRAITOWA



SOMEITY

MIRAITOWA E SOMEITY



MIRAITOWA É A MASCOTE OFICIAL DOS JOGOS OLÍMPICOS DE VERÃO.

SOMEITY É A MASCOTE OFICIAL DOS JOGOS PARALÍMPICOS DE VERÃO;

MIRAITOWA É NOMEADO DAS PALAVRAS JAPONESAS "FUTURO" E "ETERNIDADE" E SOMEITY É NOMEADO DE SOMEYOSHINO, UM TIPO DE FLOR. O NOME DE SOMEITY TAMBÉM FAZ REFERÊNCIA À FRASE EM INGLÊS "TÃO PODEROSO".



PINTE A QUANTIDADE INDICADA EM CADA TABELA

6

| | | | | | |
|--|--|--|--|--|--|
| | | | | | |
| | | | | | |
| | | | | | |
| | | | | | |
| | | | | | |

12

| | | | | | |
|--|--|--|--|--|--|
| | | | | | |
| | | | | | |
| | | | | | |
| | | | | | |
| | | | | | |

18

| | | | | | |
|--|--|--|--|--|--|
| | | | | | |
| | | | | | |
| | | | | | |
| | | | | | |
| | | | | | |



22

| | | | | | |
|--|--|--|--|--|--|
| | | | | | |
| | | | | | |
| | | | | | |
| | | | | | |
| | | | | | |

NOME:

IBIÚNA, _____ DE JULHO DE _____

20/07/2021

FORME AS PALAVRAS



GOL + FE =



HAN + DE + BOL =



HÓ + QUEI =



JU + DÔ =



KA + RA + TÊ =



MA + RA + TO + NA =



















































































RE + MO =

BASQUETE

"COM PRECISÃO, COLOCAR A BOLA NA CESTA."

VAMOS PINTAR AS BOLAS!



| | |
|---|---|
| 3 |          |
| 5 |          |
| 7 |          |
| 9 |          |
| 1 |          |
| 4 |          |
| 8 |          |
| 6 |          |
| 2 |          |

NOME:

IBIÚNA, _____ DE JULHO DE _____

21/07/2021

CIRCULE A PALAVRA DE ACORDO COM O NOME DE CADA FIGURA



BOLA

BOCA

BOTA



FRITO

APITO

PALITO

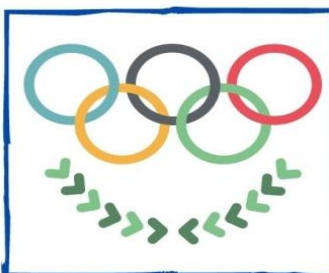

PAPÉIS

PASTÉIS

ANÉIS

VEJA A PALAVRA ABAIXO E COMPLETE

MEDALHAS

ESSA PALAVRA TEM QUANTAS LETRAS?

QUANTAS VOGAIS TEM ESSA PALAVRA?

QUAL É A LETRA INICIAL?

QUANTAS CONSOANTES?

AGORA PINTE AS VOGAIS DE VERDE E AS CONSOANTES DE ROXO

MEDALHAS



NOME:

IBIÚNA, _____ DE JULHO DE _____

22/07/2021

VAMOS COLORIR SOMENTE AS MEDALHAS
CUJO A SOMA DOS NÚMEROS É 10

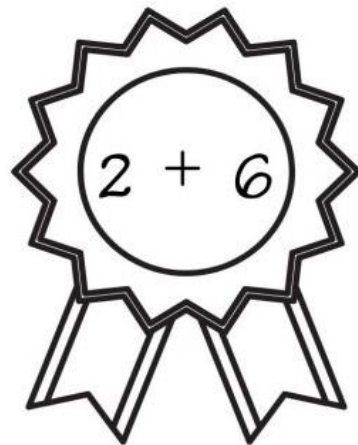
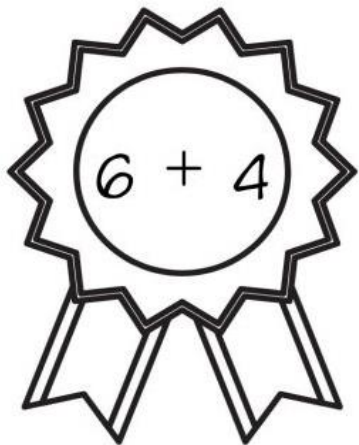
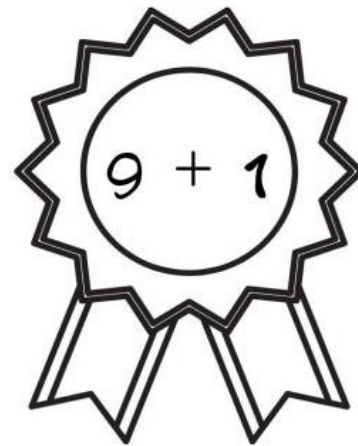
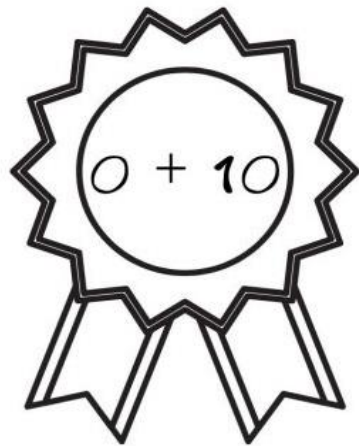

Mistura de Alegria

ATIVIDADE SOBRE OLIMPIADAS

Ligue os desenhos de acordo com os esportes:



NATAÇÃO
.....

BOXE
.....

HIPISMO
.....

REMO
.....

TÊNIS
.....

FUTEBOL
.....

CICLISMO
.....

NOME:

IBIÚNA, _____ DE JULHO DE _____

23/07/2021





COMPLETE A SEQUÊNCIA NUMÉRICA



1 4 5 7 8 13 10

GINÁSTICA ARTÍSTICA

"PULAR, VOAR... TUDO COM GRANDE BELEZA"

VAMOS COMPLETAR O NOME DAS MODALIDADES ABAIXO, COLOCANDO AS LETRAS QUE FALTAM.

| | | | |
|---|---|---|---|
|  |  |  |  |
| __RGOLAS | __ARRA __IXA | __AVALO __OM __LÇA | __OLO |

| | | |
|---|---|---|
|  |  |  |
| __ARRAS __SSIMÉTRICAS | __RAVE | __ARRAS __ARALELAS |

NOME:

IBIÚNA, _____ DE JULHO DE _____

26/07/2021

PINTE AS LETRAS DO SEU NOME

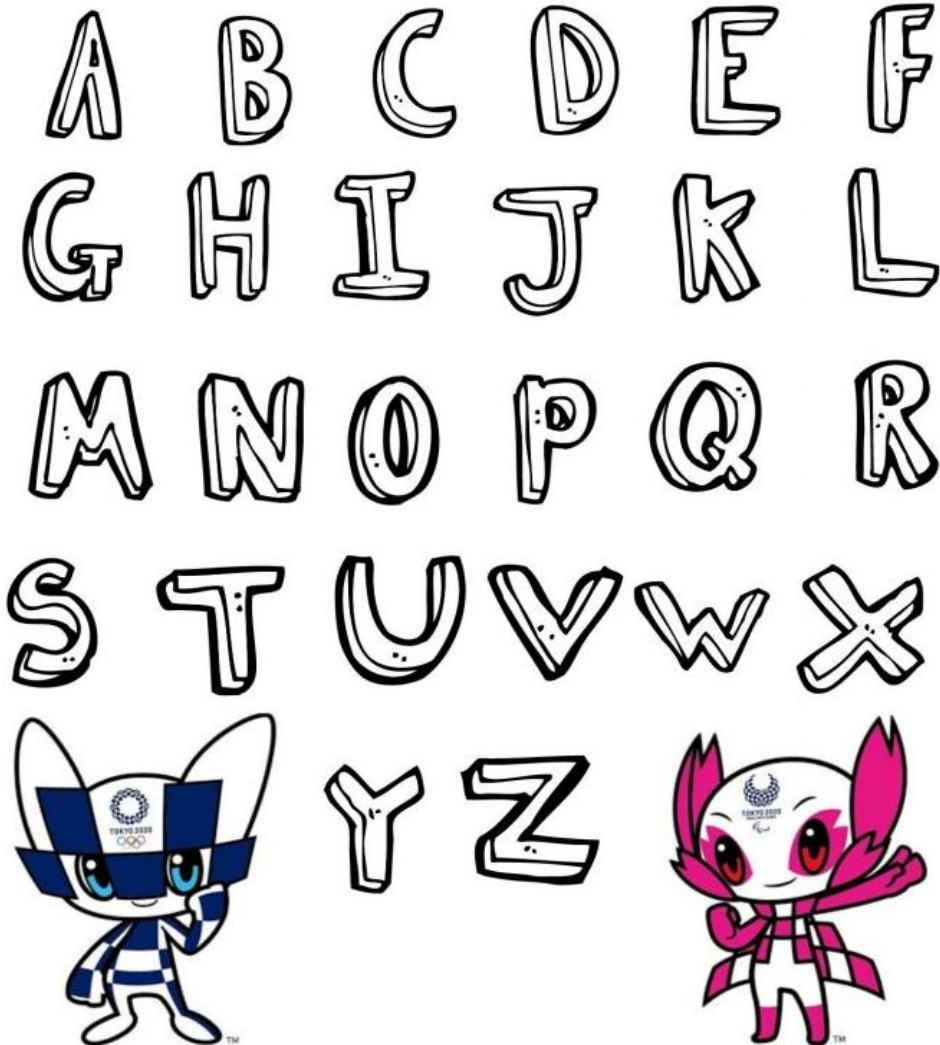

PINTE OS ANÉIS OLÍMPICOS DA MESMA COR.

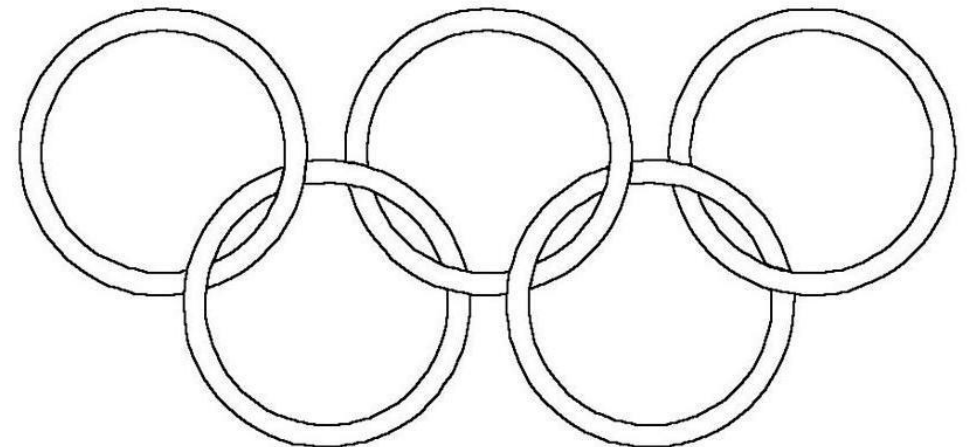

ESCOLA MUNICIPAL "PADRE ELÍDIO MANTOVANI"

NOME:

IBIÚNA, _____ DE JULHO DE _____

27/07/2021

VAMOS COLORIR OS ANÉIS OLÍMPICOS

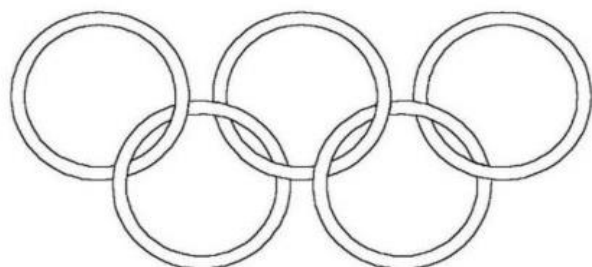

SÃO CINCO ANÉIS DE CORES DIFERENTES:
(AZUL, VERMELHO, PRETO, AMARELO E VERDE)

LIGUE DE ACORDO COM A COR QUE
REPRESENTA CADA CONTINENTE

AMARELO

AMÉRICA

VERDE

ÁSIA

PRETO

EUROPA

VERMELHO

ÁFRICA

AZUL

OCEÂNIA

CAÇA PALAVRAS

| | | | | | | | | | | | | |
|---|---|---|---|---|---|---|---|---|---|---|---|---|
| M | E | D | A | L | H | A | S | W | Q | A | T | S |
| F | Q | B | N | M | C | D | A | E | R | U | O | X |
| G | K | Ç | J | O | G | O | S | T | I | O | C | Z |
| J | H | Y | R | T | V | I | E | O | K | P | H | C |
| T | O | R | C | I | D | A | G | D | A | Z | A | V |

ESCREVA AQUI AS PALAVRAS QUE
VOCÊ ENCONTROU!

NOME:

IBIÚNA, _____ DE JULHO DE _____

28/07/2021

CRUZADINHA

TEM NAS OLIMPIADAS!

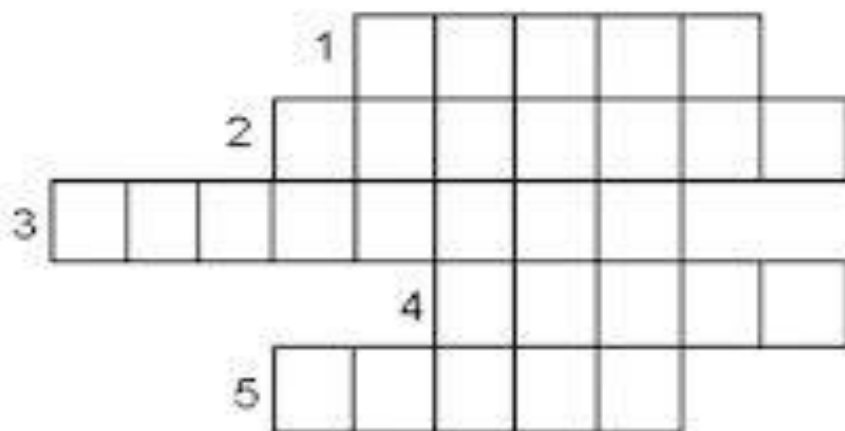

- 1- PÓDIO
- 2- ATLETAS
- 3- MEDALHAS

- 4- TOCHA
- 5- JOGOS

PINTE AS LETRAS DA PALAVRA QUE SE PEDE E ESCREVA ABAIXO

NAS OLIMPIADAS TORCEMOS PELO

R B S N R I L V D

ESTA É A BANDEIRA DO BRASIL:



ESCREVA OS NOMES DAS CORES DA BANDEIRA

NOME:

IBIÚNA, _____ DE JULHO DE _____

29/07/2021

DITADO DOS ESPORTES OLÍMPICOS



DESENHE O CAMINHO

LEVE A BOLA ATÉ O GOL.



NOME:

IBIÚNA, _____ DE JULHO DE _____

30/07/2021

HANDEBOL

"SALTAR E FAZER GOL... COM A MÃO."



VAMOS CONTAR AS BOLAS!

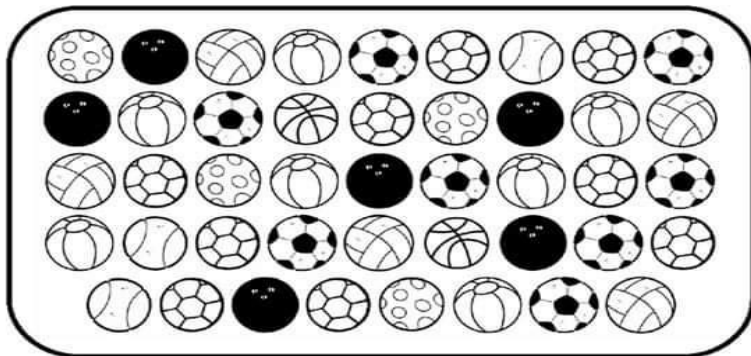

| | | | | | | | |
|--|--|--|--|--|--|--|--|
| | | | | | | | |
| | | | | | | | |

BADMINTON

"MOVIMENTAR-SE RÁPIDO E REBATER A PETECA."



VAMOS PROCURAR E PINTAR A PALAVRA PETECA NO QUADRO ABAIXO!

| | | | | | | | | | | | | |
|---|---|---|---|---|---|---|---|---|---|---|---|---|
| Q | W | E | R | T | Y | U | P | E | T | E | C | A |
| P | E | T | E | C | A | I | O | P | A | S | D | F |
| G | H | J | K | P | E | T | E | C | A | L | Z | X |
| C | P | E | T | E | C | A | V | B | N | M | Q | A |
| Z | W | S | P | E | T | E | C | A | X | E | D | C |
| R | F | V | T | G | B | P | E | T | E | C | A | Y |
| H | N | P | E | T | E | C | A | U | J | M | I | K |
| O | L | P | M | N | P | E | T | E | C | A | B | V |

QUANTAS VEZES A PALAVRA PETECA APARECEU?

NOME:

IBIÚNA, _____ DE AGOSTO DE _____

02/08/2021

HÁBITOS SAUDÁVEIS

Além de nos alimentarmos corretamente, devemos ter outras atitudes para que nossa saúde seja conservada. Uma delas é praticar atividades físicas.



Veja os esportes a seguir e pinte os que você já praticou ou pratica.

JUDÔ

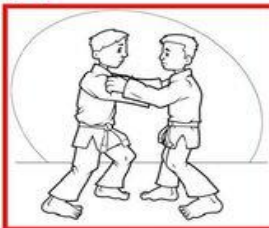

FUTEBOL



NATAÇÃO

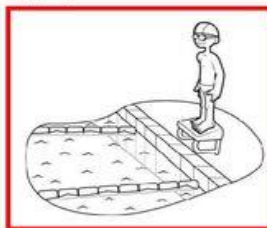

TÊNIS

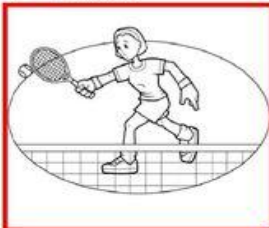

CICLISMO

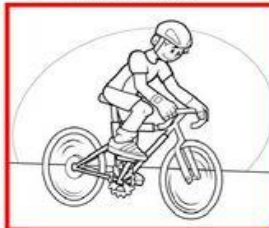

VÔLEI



Imagens disponíveis em: <https://www.smartkids.com.br/desenhos-para-colorir/e/esportes> e Software Boardmaker.

Spaço Educar: Sílvia Formiga e Madalena Dornelas.
<https://madalenaclaudia.blogspot.com>

VOLEI DE PRAIA

"IR BUSCAR UMA BOLA LONGE, SEM DEIXÁ-LA CAIR."

VAMOS DESCOBRIR AS 7 DIFERENÇAS!!



www.materiaispdg.com.br

NOME:

IBIÚNA, _____ DE AGOSTO DE _____

03/08/2021

CICLISMO

"PEDALAR MUITO... USANDO UM CAPACETE SUPERDIFERENTE!"



VAMOS AJUDAR O CASCAO A
CHEGAR ATÉ O FINAL DA PROVA!

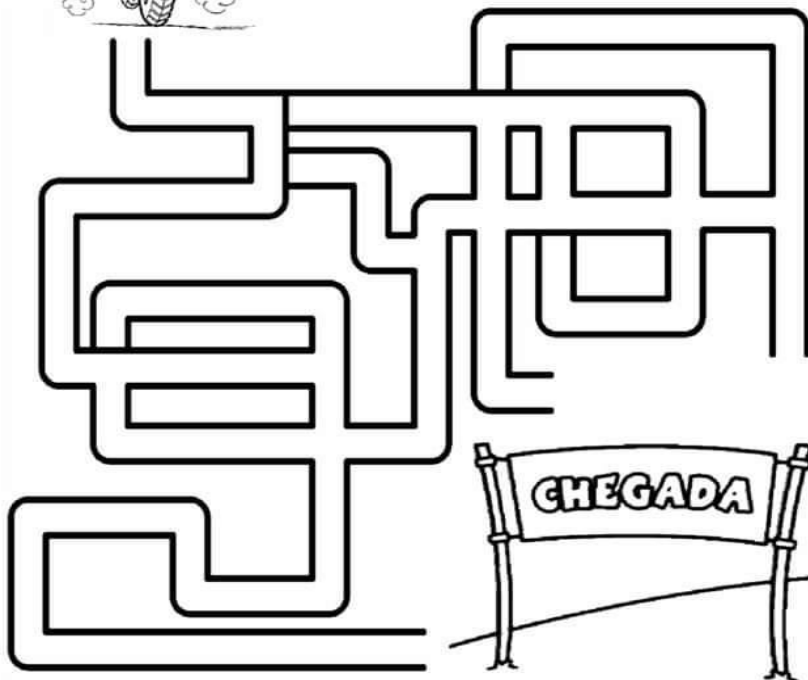

CANOAGEM



VAMOS CIRCULAR AS FIGURAS QUE INICIAM
COM A MESMA SÍLABA DA PALAVRA CANOAGEM.



NOME:

IBIÚNA, _____ DE AGOSTO DE _____

04/08/2021

FUTEBOL

"DRIBLAR E FAZER UM... GOOOOOOL."

O CASÇÃO VAI JOGAR FUTEBOL COM SUA TURMA NO CAMPINHO. VAMOS AJUDÁ-LO A ENCONTRAR SEUS AMIGOS SEGUINDO A TRILHA DO ALFABETO

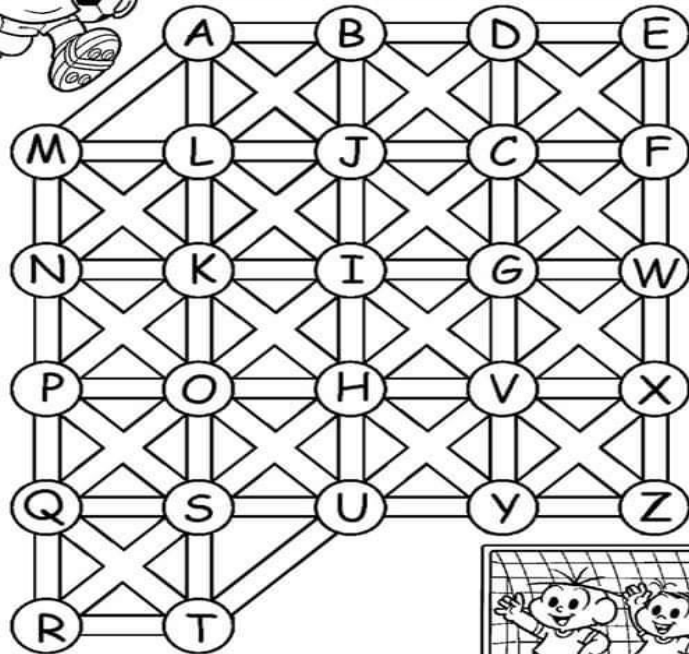

BOXE

"SE ESQUIVAR... E ACERTAR UM GOLPE"

VAMOS PINTAR O CAMINHO QUE TEM APENAS LETRAS PARA DESCOBRIR QUEM GANHOU A LUTA DE BOXE!

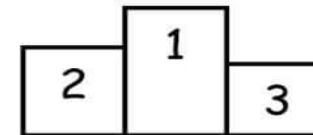
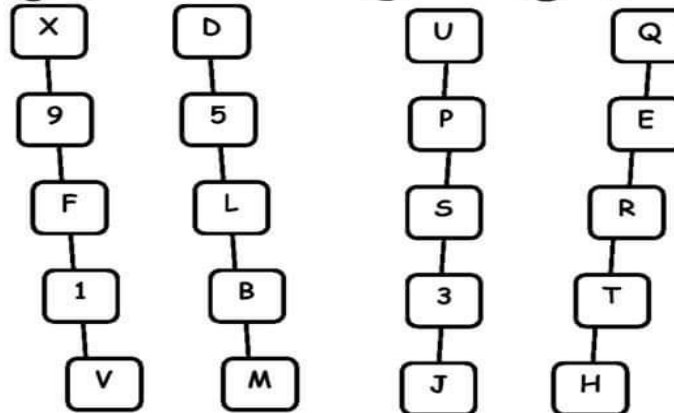

O CAMPEÃO FOI _____

NOME:

IBIÚNA, _____ DE AGOSTO DE _____

05/08/2021

Mistura de Alegria

LIGUE CORRETAMENTE

TRÊS

QUATRO

DOIS

CINCO

UM

www.misturadealegria.blogspot.com.br Adiléa

CAÇA-PALAVRAS DAS OLIMPÍADAS

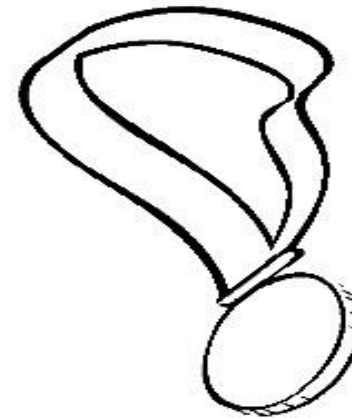

- 1- _____
- 2- _____
- 3- _____

| | | | | | | | |
|---|---|---|---|---|---|---|---|
| X | X | O | U | R | O | X | X |
| X | X | X | X | X | X | X | X |
| P | R | A | T | A | X | X | X |
| X | X | X | X | X | X | X | X |
| X | B | R | O | N | Z | E | X |

NOME:

IBIÚNA, _____ DE AGOSTO DE _____

06/08/2021

LIGUE AS BOLAS AOS SEUS ESPORTES



FUTEBOL



GOLF



TÊNIS



BASQUETE



HANDBOL

BRINCANDO DE TRAVA-LÍNGUA



ZECA JOGA
JOGA ZICO
JUCA JOGA
JOGA JOCA.



ESCREVA A PALAVRA QUE MAIS SE REPETE

QUANTAS VEZES ESSA PALAVRA APARECE?

QUANTAS LETRAS ELA TEM?

QUANTAS VOGAIS TEM NO TEXTO?