



PREFEITURA DA ESTÂNCIA TURÍSTICA DE IBIÚNA
EM PROF. CALIL RAHAL NETO

Rua Projetada, 620 - Capim Azedo - Ibiúna - SP - Telefone: 3241-5917



8ª. APOSTILA DE ESTUDOS ATIVIDADES NÃO PRESENCIAIS 3º BIMESTRE



ENSINO FUNDAMENTAL

ALUNO: _____

PROFESSORA: CAMILA AZEVEDO

TURMA: 1º ANO C

DATA DE DEVOLUÇÃO: 10/08/2021



E. M. "PROF.º. CALIL RAHAL NETO".

NOME: _____

PROFESSORA: CAMILA

TURMA: 1º ANO C

DATA: 05/07/2021

ATIVIDADE DE LÍNGUA PORTUGUESA

COMPLETE COM AS LETRAS VIZINHAS:

B

O

E

G

C

I

N

T





E. M. "PROF. CALIL RAHAL NETO".

NOME: _____

PROFESSORA: CAMILA

TURMA: 1º ANO C

DATA: 06/07/2021

ATIVIDADE DE MATEMÁTICA

ESTA É UMA FOTOGRAFIA DO ANIVERSÁRIO DA MAGALI.



1. QUANTOS ANOS A MAGALI ESTÁ FAZENDO?

2. QUANTAS MENINAS APARECEM NA FOTOGRAFIA?

3. QUANTOS MENINOS APARECEM NA FOTOGRAFIA?

4. QUANTAS CRIANÇAS TÊM AO TODO?

5. VAMOS PINTAR UMA FATIA DA TORTA PARA CADA CRIANÇA QUE APARECE NA FOTOGRAFIA:

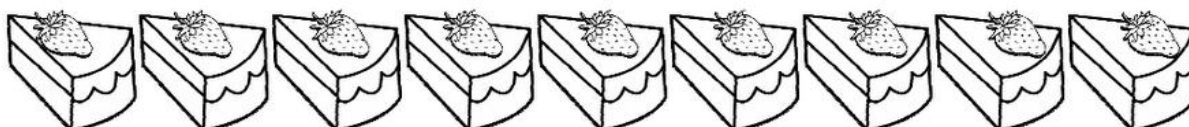



E. M. "PROF.º. CALIL RAHAL NETO".

NOME: _____

PROFESSORA: CAMILA

TURMA: 1º ANO C

DATA: 19/07/2021

ATIVIDADE DE LÍNGUA PORTUGUESA

1- COLOQUE A INICIAL DAS FIGURAS:

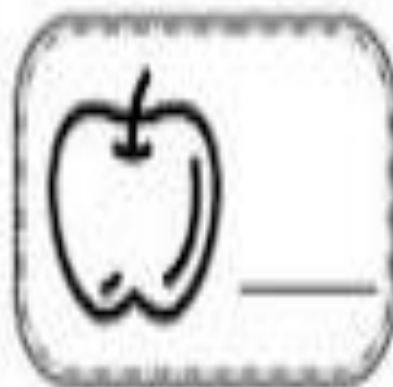



E. M. "PROF.º. CALIL RAHAL NETO".

NOME: _____

PROFESSORA: CAMILA

TURMA: 1º ANO C

DATA: 20/07/2021

ATIVIDADE DE MATEMÁTICA

PINTE O AQUÁRIO QUE POSSUI MAIS PEIXES.



CONTORNE A CAIXA DE COR QUE POSSUI MENOS LÁPIS.

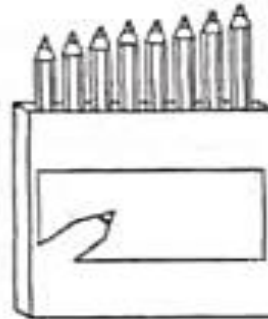

OBSERVE A CENA, CONTE E CALCULE.

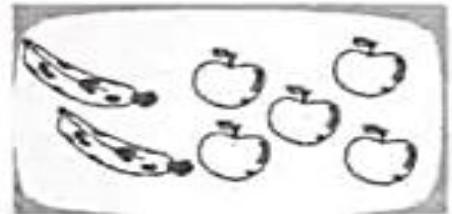

- ✓ QUANTAS BANANAS TÊM? _____
- ✓ QUANTAS MAÇÃS TÊM? _____

- ✓ O QUE TEM MAIS, BANANAS OU MAÇÃS?
- ✓ QUANTAS FRUTAS TÊM AO TODO? _____



E. M. "PROF.º. CALIL RAHAL NETO".

NOME: _____

PROFESSORA: CAMILA

TURMA: 1º ANO C

DATA: 21/07/2021

ATIVIDADE DE LÍNGUA PORTUGUESA

1-FAÇA A CORRESPONDÊNCIA E ESCREVA A SÍLABA INICIAL DE CADA PALAVRA.

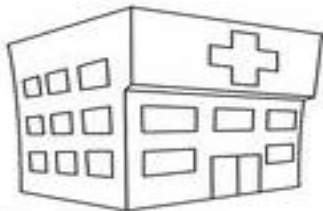

SPITAL



LICÓPTEROC



RPA

HA

HE

HI

HO

HU



MANO



LICE



MEM



POPÓTAMO



ENA



E. M. "PROF.º. CALIL RAHAL NETO".

NOME: _____

PROFESSORA: CAMILA

TURMA: 1º ANO C

DATA: 22/07/2021

ATIVIDADE DE LÍNGUA PORTUGUESA



VAMOS COMPLETAR AS PALAVRAS:

JA - JE - JI - JO - JU

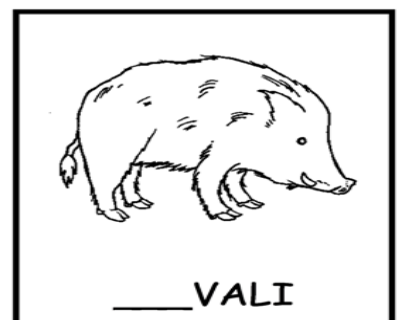
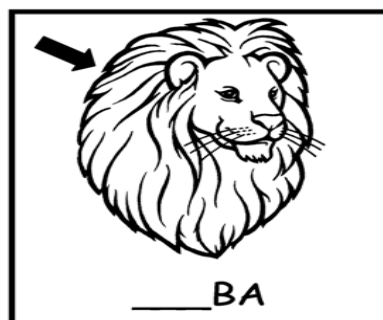
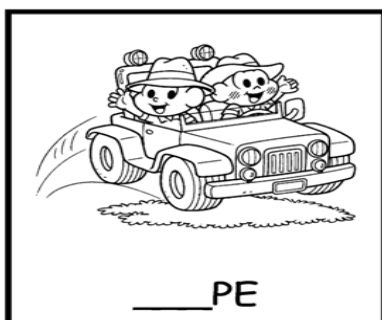
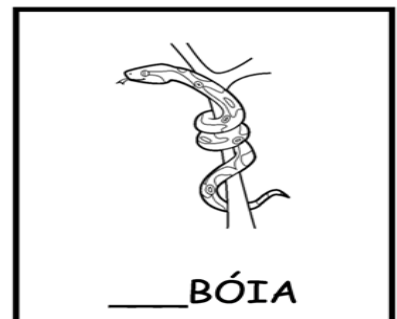
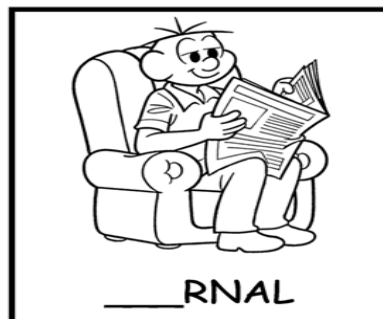
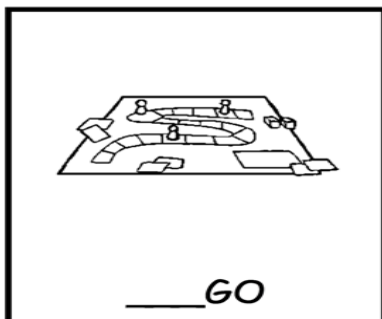
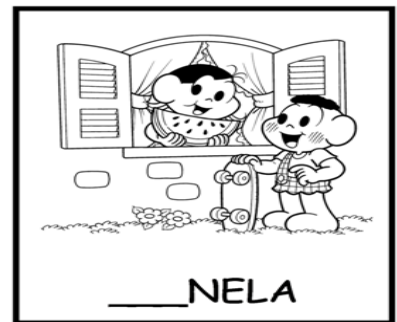



E. M. "PROF. CALIL RAHAL NETO".

NOME: _____

PROFESSORA: CAMILA

TURMA: 1º ANO C

DATA: 23/07/2021

ATIVIDADE DE MATEMÁTICA

LIGUE CADA CONJUNTO DE GATOS A SUA QUANTIDADE.

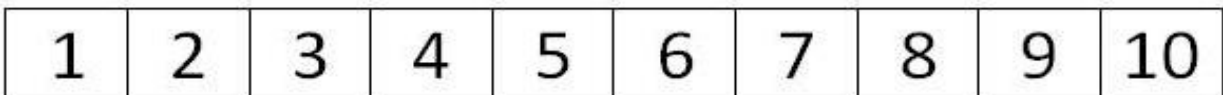
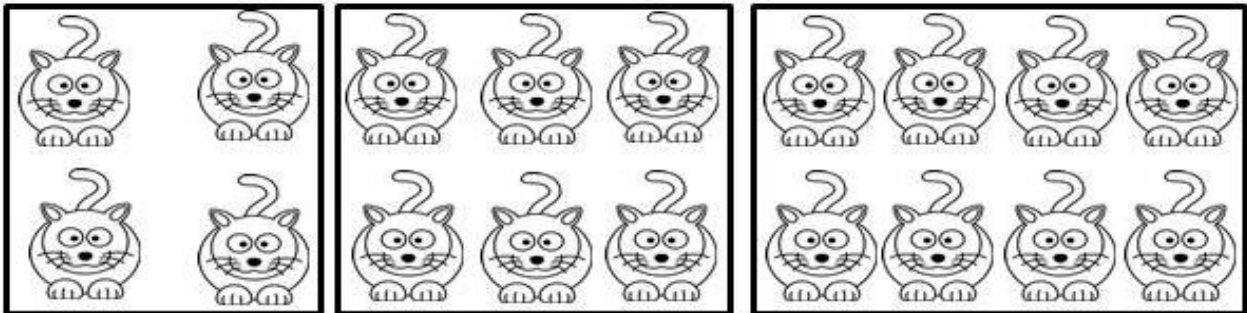

PINTE O CONJUNTO QUE TEM MAIS GATOS.

LIGUE O GATO A SEU FILHOTE





E. M. "PROF.º. CALIL RAHAL NETO".

NOME: _____

PROFESSORA: CAMILA

TURMA: 1º ANO C

DATA: 26/07/2021

26 DE JULHO - DIA DOS AVÓS

LÍNGUA PORTUGUESA

MEU BEM! PROCURE NO TEXTO ABAIXO A PALAVRA VOVÓ E CIRCULE.

A CASINHA DA VOVÓ

A CASINHA DA VOVÓ
CERCADINHA DE CIPÓ
O CAFÉ ESTÁ DEMORANDO
COM CERTEZA NÃO TEM PÓ.



AGORA, COMPLETE O QUADRO COM O QUE SE PEDE:

	LETRA INICIAL	LETRA FINAL	NÚMERO DE LETRAS
VOVÓ			
CIPÓ			
CAFÉ			
PÓ			



E. M. "PROF.º. CALIL RAHAL NETO".

NOME: _____

PROFESSORA: CAMILA

TURMA: 1º ANO C

DATA: 26/07/2021

ATIVIDADE DE MATEMÁTICA

ESTA É A VOVÓ DE BETO. ELA IRÁ FAZER OS DOCINHOS DE ACORDO COM A QUANTIDADE DE CEREJAS.

- COMPLETE OBSERVANDO A CENA:



- QUANTOS DOCINHOS VOVÓ JÁ FEZ?

- QUANTOS DOCINHOS AINDA FALTAM?

- QUANTOS DOCINHOS SERÃO AO TODO?

- ESTES DOCINHOS JÁ ESTÃO PRONTOS.



- QUANTAS BANDEJAS DE DOCES?

- QUANTOS DOCES EM CADA BANDEJA?

- QUANTOS DOCES AO TODO?



E. M. "PROF.º. CALIL RAHAL NETO".

NOME: _____

PROFESSORA: CAMILA

TURMA: 1º ANO C

DATA: 27/07/2021

ATIVIDADE DE LÍNGUA PORTUGUESA

JA - JE - JI - JO - JU

1-COMPLETE AS PALAVRAS COM A SÍLABA INICIAL CORRESPONDENTE



VALI

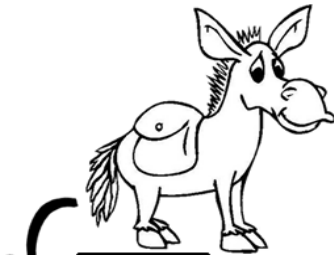

MENTO



GUE

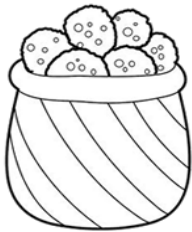

JUBA

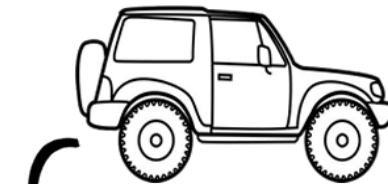

PE



ÍZ



ANINHA

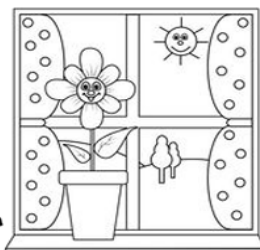

NELA

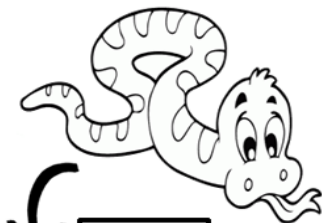

BÓIA



E. M. "PROF. CALIL RAHAL NETO".

NOME: _____

PROFESSORA: CAMILA

TURMA: 1º ANO C

DATA: 27/07/2021

ATIVIDADE DE MATEMÁTICA

OBSERVE O GRÁFICO DE ROUPAS ARRECADADAS PELAS CRIANÇAS E RESPONDA AS QUESTÕES A SEGUIR.

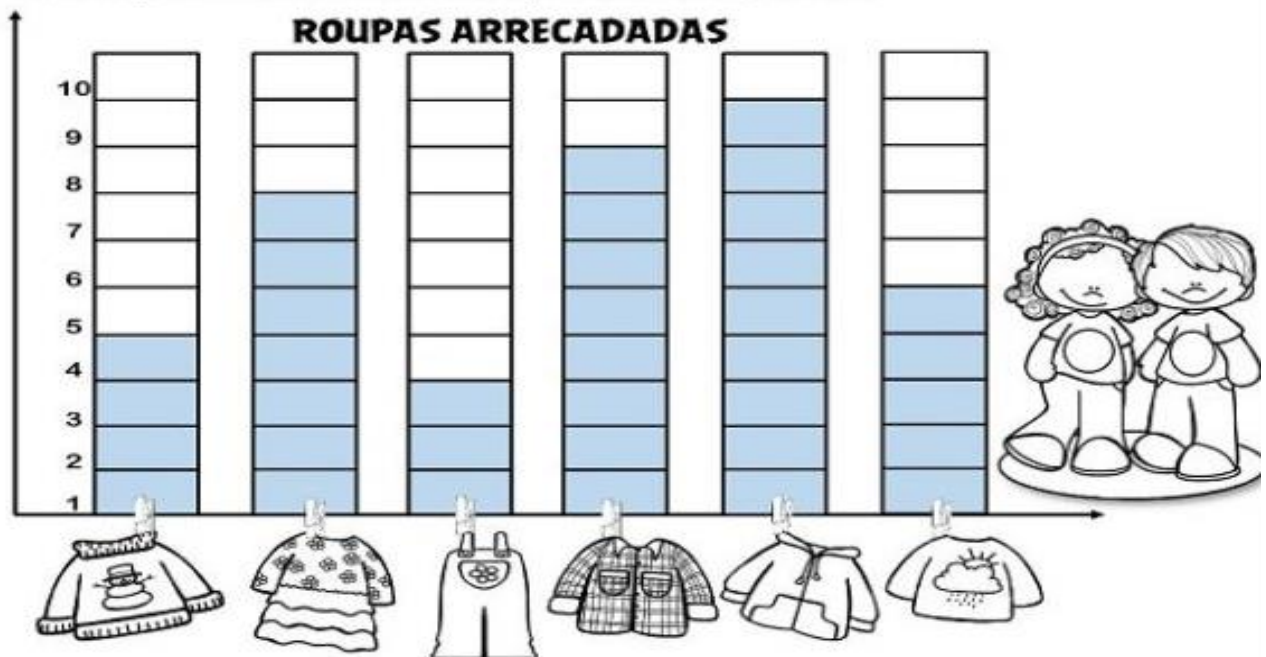

- QUANTOS?

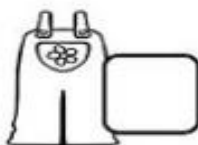

QUANTOS  A MAIS

QUE



?

QUANTAS  A MENOS

QUE



?



E. M. "PROF.º. CALIL RAHAL NETO".

NOME: _____

PROFESSORA: CAMILA

TURMA: 1º ANO C

DATA: 28/07/2021

ATIVIDADE DE LÍNGUA PORTUGUESA

COMPLETE AS PALAVRAS ABAIXO COM AS SÍLABAS:

KA – KE – KI – KO – KU

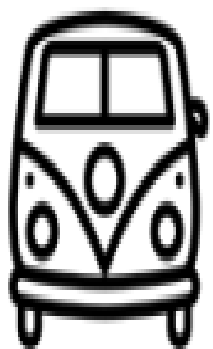

_____ MBI



_____ TCHUP



_____ BON

KIBON®



_____ RAOKÊ



E. M. "PROF.º. CALIL RAHAL NETO".

NOME: _____

PROFESSORA: CAMILA

TURMA: 1º ANO C

DATA: 28/07/2021

MARQUE A OPÇÃO CORRETA E RESPONDA:

• COMO ESTÁ O TEMPO HOJE?

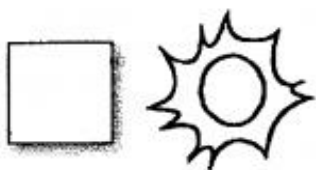

• CIRCULE O MÊS EM QUE ESTAMOS.

JANEIRO

FEVEREIRO

MARÇO

ABRIL

MAIO

JUNHO

JULHO

AGOSTO

SETEMBRO

OUTUBRO

NOVEMBRO

DEZEMBRO

• EM QUAL ESTAÇÃO ESTAMOS? PINTE O QUADRINHO RELACIONADO.



PRIMAVERA



VERÃO



OUTONO

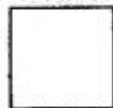

INVERNO





E. M. "PROF.º. CALIL RAHAL NETO".

NOME: _____

PROFESSORA: CAMILA

TURMA: 1º ANO C

DATA: 29/07/2021

GEOGRAFIA

SITUAÇÕES DE CONVÍVIO/BRINCAR É MUITO BOM

VOCÊ DEVE TER MUITOS AMIGOS NA SUA RUA, NÃO É?
COMO VOCÊS BRINCAM?

DESENHE VOCÊ E SEUS AMIGOS BRINCANDO.

A large, empty rounded rectangle with a thin black border, intended for the student to draw themselves and their friends playing.

**COM AJUDA DE SEUS FAMILIARES, ESCREVA O NOME DA
BRINCADEIRA DE QUE VOCÊS MAIS GOSTAM.**



E. M. "PROF.º. CALIL RAHAL NETO".

NOME: _____

PROFESSORA: CAMILA

TURMA: 1º ANO C

DATA: 29/07/2021

VAMOS JOGAR PETECA?

VOCÊ VAI PRECISAR DE FOLHAS DE JORNAL, BARBANTE E TESOURA.

FAÇA UMA BOLINHA DE PAPEL AMASSADO. CUBRA A BOLINHA COM UMA FOLHA DUPLA DE JORNAL E AMARRE COM BARBANTE. OBSERVE O DESENHO E SIGA OS PASSOS.

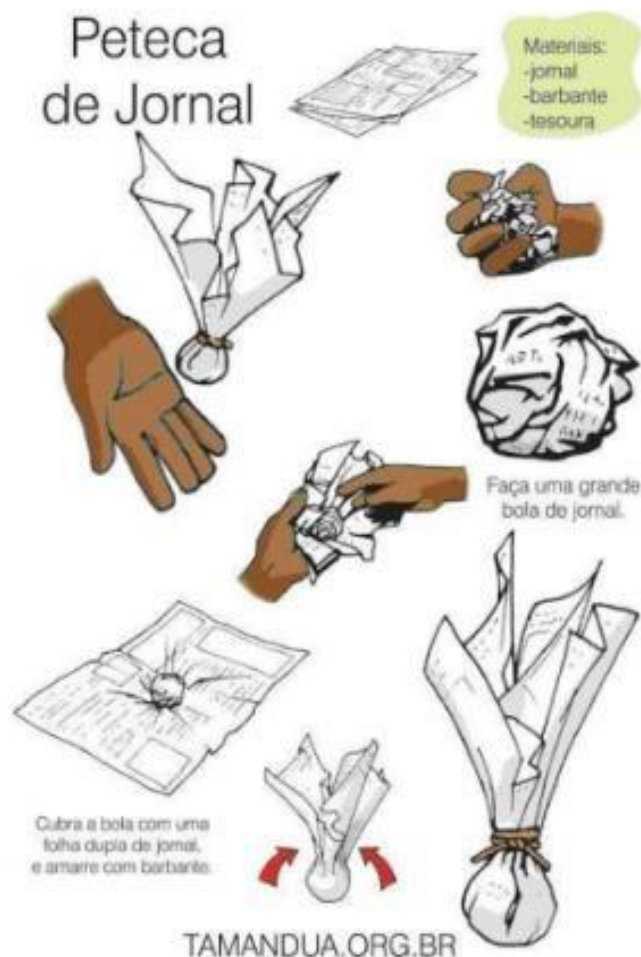

Fonte: www.artesanato.passoapassoja.com.br

A SUA BOLINHA FICOU PRONTA? AGORA É SÓ JOGAR COM SEUS FAMILIARES E SE DIVERTIR!



E. M. "PROF.º. CALIL RAHAL NETO".

NOME: _____

PROFESSORA: CAMILA

TURMA: 1º ANO C

DATA: 30/07/2021

ATIVIDADE DE LÍNGUA PORTUGUESA



É MUITO IMPORTANTE
TER UMA FAMÍLIA!

- 1) LEIA A QUADRINHA ABAIXO COM AJUDA DE ALGUÉM DE SUA FAMÍLIA.

MINHA FAMÍLIA

EU TENHO UMA FAMÍLIA
MUITO LINDA DE SE VER.
VIVEMOS TODOS EM HARMONIA,
SOMOS FELIZES PRA VALER!

Graça Boquet

- 2) COMPLETE O CRUZADÃO.

F	A	M	Í	L	I	A
	A			L		
		M			I	
	A					
			Í			A





E. M. "PROF.º. CALIL RAHAL NETO".

NOME: _____

PROFESSORA: CAMILA

TURMA: 1º ANO C

DATA: 30/07/2021



DESAFIO FÁCIL

- 1) VEJA A CENA ABAIXO E, DEPOIS, RESPONDA ÀS PERGUNT. REGISTRANDO COM NUMERAIS.



- 2) QUANTAS PESSOAS HÁ NESSA FAMÍLIA?

- QUANTOS ADULTOS?
- QUANTOS HOMENS?
- QUANTAS MULHERES?
- QUANTAS CRIANÇAS?
- QUANTOS MENINOS?
- QUANTAS MENINAS?

- 3) AGORA, PINTE A CENA.



E. M. "PROF.º. CALIL RAHAL NETO".

NOME: _____

PROFESSORA: CAMILA

TURMA: 1º ANO C

DATA: 02/08/2021

OS DIAS DA SEMANA

1. NUMERE DE 1 A 7 OS DIAS DA SEMANA.

DOMINGO

SEGUNDA-FEIRA

TERÇA-FEIRA

QUARTA-FEIRA

QUINTA-FEIRA

SEXTA-FEIRA

SÁBADO

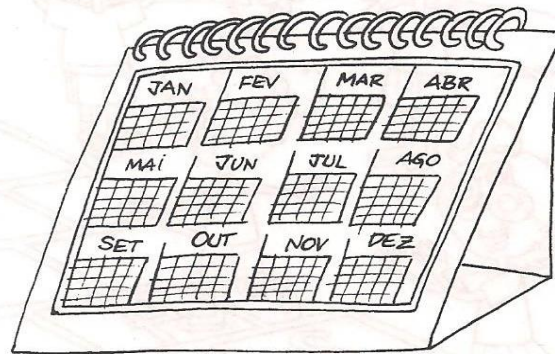

2. QUANTOS DIAS TEM UMA SEMANA?

3. QUAL É O PRIMEIRO DIA DA SEMANA?

4. QUAL É O SÉTIMO DIA DA SEMANA?

5. QUE DIA É HOJE?

6. QUANTOS DIAS FALTAM PARA TERMINAR ESTA SEMANA? MARQUE ABAIXO.

0

1

2

3

4

5

6



E. M. "PROF.º. CALIL RAHAL NETO".

NOME: _____

PROFESSORA: CAMILA TURMA: 1º ANO C DATA: 02/08/2021

DIA E NOITE

DEPOIS DE CADA DIA VEM A NOITE, E DEPOIS DE CADA NOITE VEM O DIA. O DIA É REPRESENTADO PELO SOL, E A NOITE É REPRESENTADA PELA LUA E AS ESTRELAS.

O PLANETA TERRA GIRA EM TORNO DO SOL.

ESSE MOVIMENTO QUE A TERRA FAZ GERA O DIA E A NOITE.

O NOME DESSE MOVIMENTO QUE GERA O DIA E A NOITE É **ROTAÇÃO**.

DE ACORDO COM ESSE PEQUENO TEXTO E O DESENHO QUE VOCÊ ASSISTIU, RESPONDA AS ATIVIDADES. SE PRECISAR PEÇA AJUDA DE UM ADULTO.

REPRESENTE COM DESENHOS BEM CAPRICHADOS COMO FICA O CÉU DURANTE O DIA E DURANTE A NOITE.

DIA	NOITE

PREENCHA A TABELA COLOCANDO AS PALAVRAS DO RETÂNGULO NO LUGAR CERTO:

SOL - LUA

DIA	
NOITE	

VOCÊ GOSTA MAIS DO DIA OU DA NOITE?



E. M. "PROF.º. CALIL RAHAL NETO".

NOME: _____

PROFESSORA: CAMILA

TURMA: 1º ANO C

DATA: 03/08/2021

DIA DOS PAIS

2º DOMINGO DE AGOSTO



A presença do pai é importante em todas as fases da vida do filho.

Hoje essa figura também pode ser representada pelo avô, pelo tio ou até mesmo por um irmão mais velho.

O importante é que essa data seja lembrada com muito carinho e ternura.



E. M. "PROF.º. CALIL RAHAL NETO".

NOME: _____

PROFESSORA: CAMILA

TURMA: 1º ANO C

DATA: 03/08/2021

1- DESENHE OU COLE UMA FOTO DO SEU...

SUPER PAI!



NOME:

PROFISSÃO:

COR PREFERIDA:

TIME DO CORAÇÃO:



E. M. "PROF.º. CALIL RAHAL NETO".

NOME: _____

PROFESSORA: CAMILA

TURMA: 1º ANO C

DATA: 04/08/2021

LINGUAGEM ESCRITA

ESCREVA O NOME DO SEU PAI E RESPONDA:

- QUAL A PRIMEIRA LETRA DO NOME DO PAI?

- QUAL A ÚLTIMA LETRA?



- QUAIS SÃO AS VOGAIS QUE APARECEM NO NOME DE SEU PAI? PINTE:

A

E

I

O

U



E. M. "PROF. CALIL RAHAL NETO".

NOME: _____

PROFESSORA: CAMILA

TURMA: 1º ANO C

DATA: 04/08/2021

AS COISAS DO PAPAÍ

VEJA AS QUANTIDADES:

			
BONÉS 6	CAMISAS 12	CALÇAS 15	CINTOS 4

REPRESENTE NO GRÁFICO:

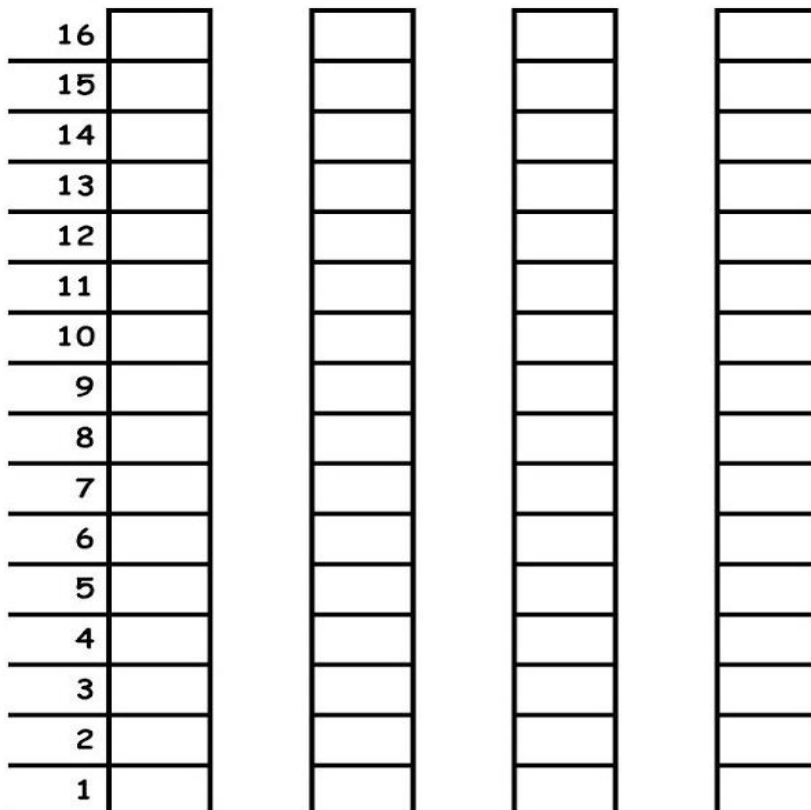

CINTOS

BONÉS

CAMISAS

CALÇAS



E. M. "PROF.º. CALIL RAHAL NETO".NOME:

PROFESSORA: CAMILA

TURMA: 1º ANO C

DATA: 05/08/2021

DESCOBRINDO PALAVRAS

OBSERVE A PRIMEIRA LETRA DA PALAVRA PAPAÍ E
PINTE-A.



PAPAÍ

PINTE UMA BOLINHA PARA CADA LETRA DA PALAVRA PAPAÍ.

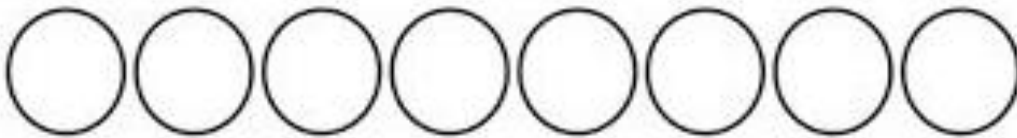

COMPLETE COM AS LETRAS QUE ESTÃO FALTANDO PARA FORMAR
A PALAVRA PAPAÍ.

P			A	
P		P		



E. M. "PROF. CALIL RAHAL NETO".

NOME: _____

PROFESSORA: CAMILA

TURMA: 1º ANO C

DATA: 05/08/2021



VAMOS CONTAR AS ROUPAS DO PAPAÍ !

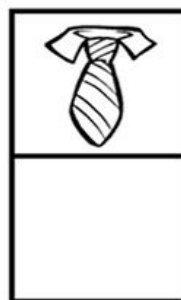
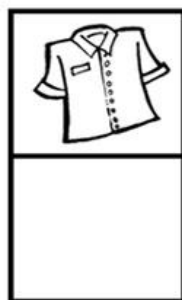
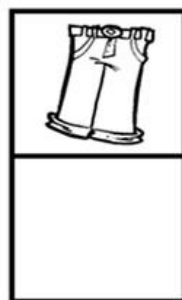
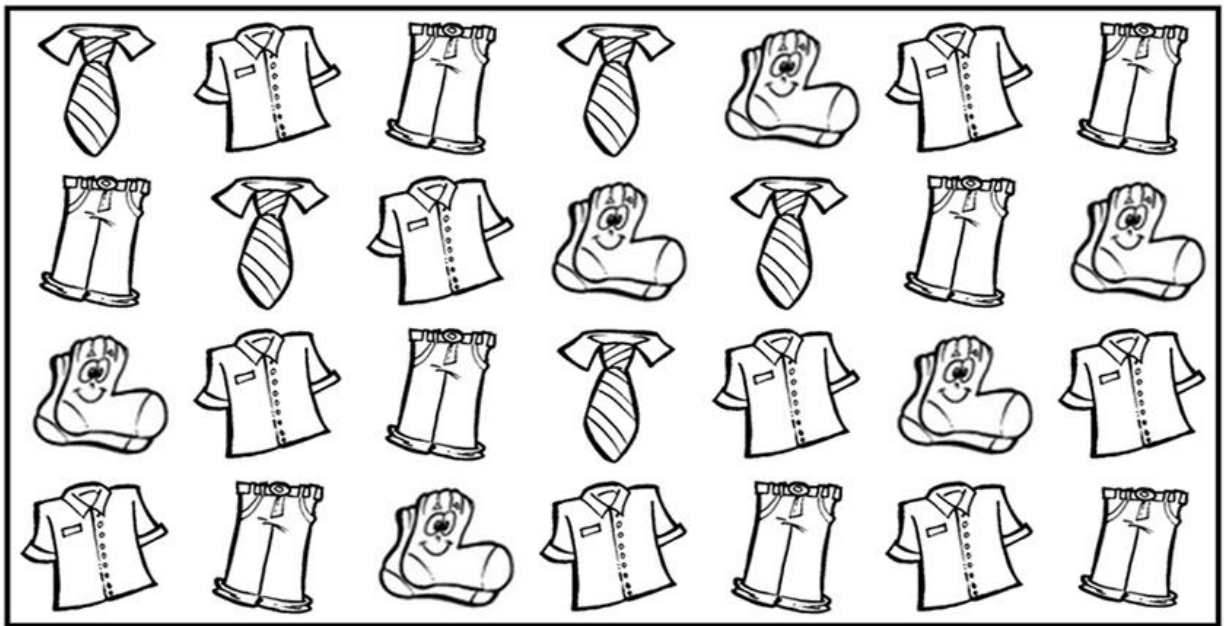



E. M. "PROFº. CALIL RAHAL NETO".

NOME: _____

PROFESSORA: CAMILA

TURMA: 1º ANO C

DATA: 06/08/2021

CONFECÇÃO DO CARTÃO DIA DOS PAIS

Referencias

<https://br.pinterest.com/pin/516084438532716799/>

<https://www.espacoprofessor.com/atividades-com-a-letra-k-em-pdf-para-imprimir/>

<https://escolaeducacao.com.br/atividades-para-o-dia-dos-pais/atividades-para-o-dia-dos-pais-vamos-contar-as-roupas-do-papai/>

<https://br.pinterest.com/marildapeas/dia-dos-pais/>

<https://br.pinterest.com/pin/630152172844188213/>

<https://br.pinterest.com/pin/401172279306112072/>

<http://alfabetizandocomunicaeturma.blogspot.com/2012/02/aniversario-da-magali-atividade.html>

<https://br.pinterest.com/leila3077/ja-je-ji-jo-ju/>

<https://br.pinterest.com/pin/382172718370316579/>

<http://www.pmbraganey.pr.gov.br/images/media/5522898795ee9259d0a27e.pdf>

<https://br.pinterest.com/pin/15481192455228882/>