

E.M. "PADRE ELÍDIO MANTOVANI"

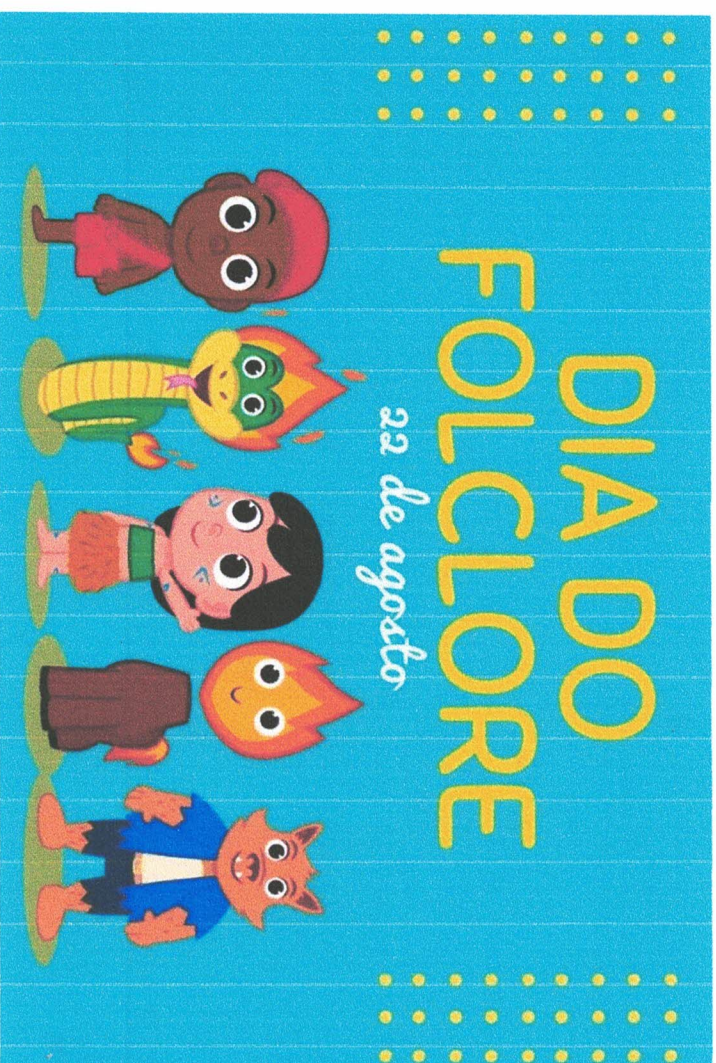

NOME: _____

1º ANO B PROFESSORA ELAINE

ATIVIDADES DE 09/08/21 À 27/08/2021

DEVOLUÇÃO: 30/08/2021

NOME:

IBIÚNA, _____ DE AGOSTO DE _____

10/08/2021

PAPAI

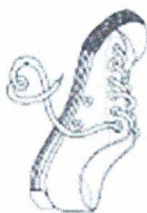

O SEU NOME É _____

COLE A FOTO DELE AQUI

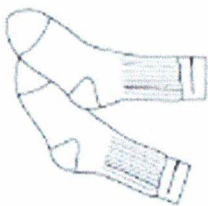
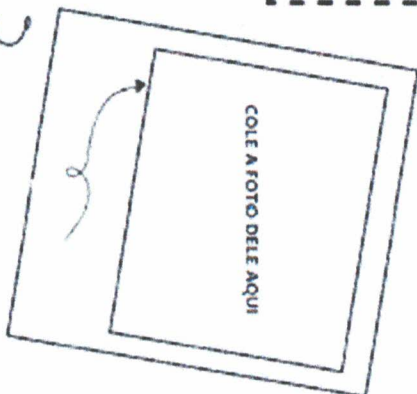

SUA COR FAVORITA É _____

SUA COMIDA FAVORITA É _____

EU GOSTO DE MEU PAI PORQUE _____

www.educacaotransformacao.com.br



VAMOS CONTAR AS ROUPAS DO PAPAÍ !

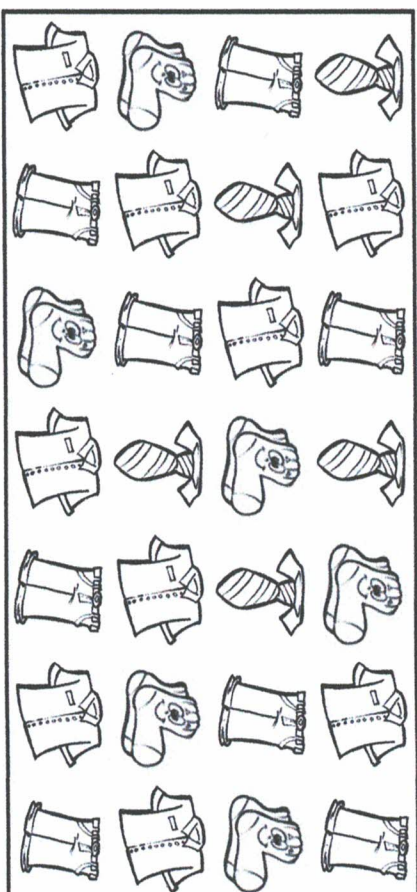

QUAL PEÇA DE ROUPA O PAPAÍ TEM MAIS? _____

QUAL PEÇA DE ROUPA O PAPAÍ TEM MENOS? _____

NOME:

IBIÚNA, _____ DE AGOSTO DE _____

11/07/2021

DIA DOS PAIS ADIVINHAS

O QUE É O QUE É...
O PAPAÍ...

1-USA NO INVERNO:

- () CASACO
- () SAIA
- () SORVETE

2-USA COM OS SAPATOS:

- () TOUCA
- () MEIA
- () LUVA

3-USA NA CABEÇA:

- () CAMISETA
- () CASACO
- () TOUCA

4-USA NA CINTURA:

- () CHAPÉU
- () CINTO
- () BONÉ



5-USA PARA ESQUENTAR O PESCOÇO NO INVERNO:

- () CACHECOL
- () CAMISA
- () MEIA

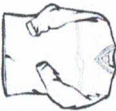

AS COISAS DO PAPAÍ

VEJA AS QUANTIDADES:

			
BONÉS 6	CAMISAS 12	CALÇAS 15	CINTOS 4

REPRESENTE NO GRÁFICO:

16				
15				
14				
13				
12				
11				
10				
9				
8				
7				
6				
5				
4				
3				
2				
1				
CINTOS	BONÉS	CAMISAS	CALÇAS	



NOME:

IBIUNA, _____ DE AGOSTO DE _____

12/08/2021

1- ENCONTRE E PINTE A PALAVRA PAI NO TEXTO ABAIXO:

MEU PAI, MEU AMIGO, FIEL COMPANHEIRO, EXEMPLO VERDADEIRO, PARA MIM...

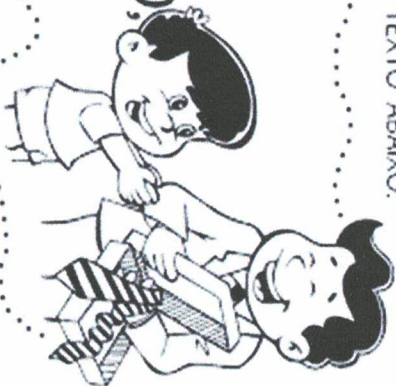

MÚSICA CRISTINA MEL

2- MEU PAI COMPLETOU UMA DÚZIA DE GRAVATAS EM SUA COLEÇÃO.
QUAL NUMERAL REPRESENTA UMA DÚZIA?

3- COMPLETE A SEQUÊNCIA NUMÉRICA NAS GRAVATAS DO PAPA!

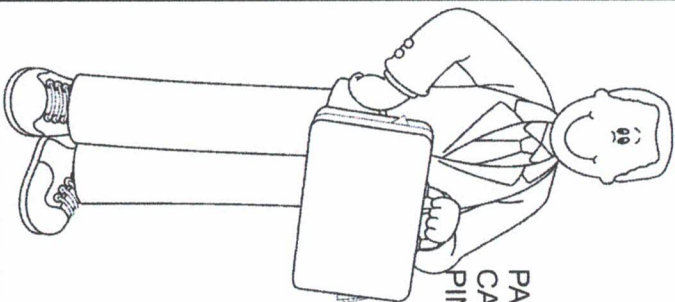
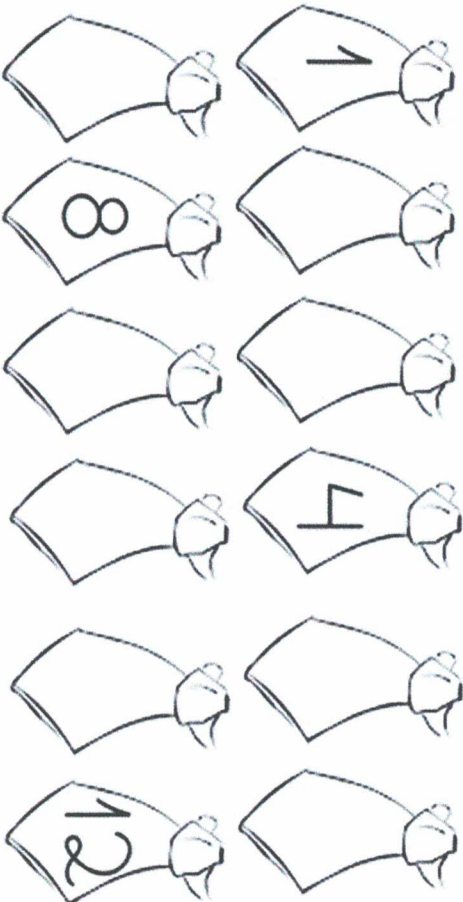

ATIVIDADE



PAPAI PRECISA DE 2 DOS OBJETOS DE CADA QUADRO EM SUA MALA. AJUDE-O PINTANDO A QUANTIDADE CORRETAMENTE.

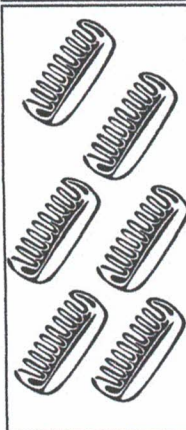
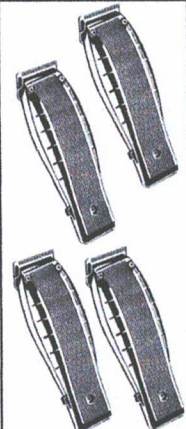
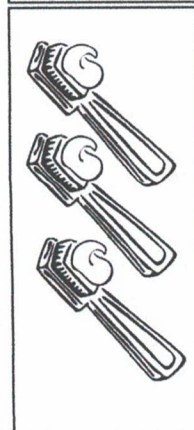
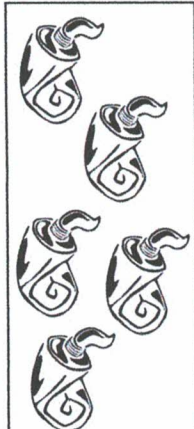
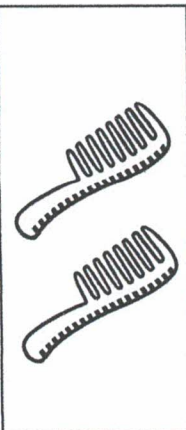
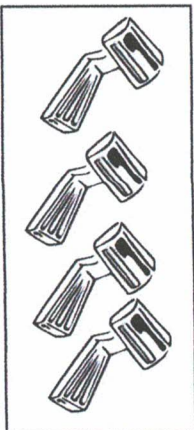

IDEIA CRIATIVA

NOME:

IBIÚNA, _____ DE AGOSTO DE _____

13/08/2021

PAPAI MORA EM MEU CORAÇÃO.
PINTE AS VOGAIS DO NOME PAI.



MEU PRESENTE PARA O PAPAI!
PINTE OS PRESENTES QUE VOCÊ GOSTARIA
DE DAR PARA O SEU PAPAI!





NOME: _____

IBIUNA, _____ DE AGOSTO DE _____

14/08/2021

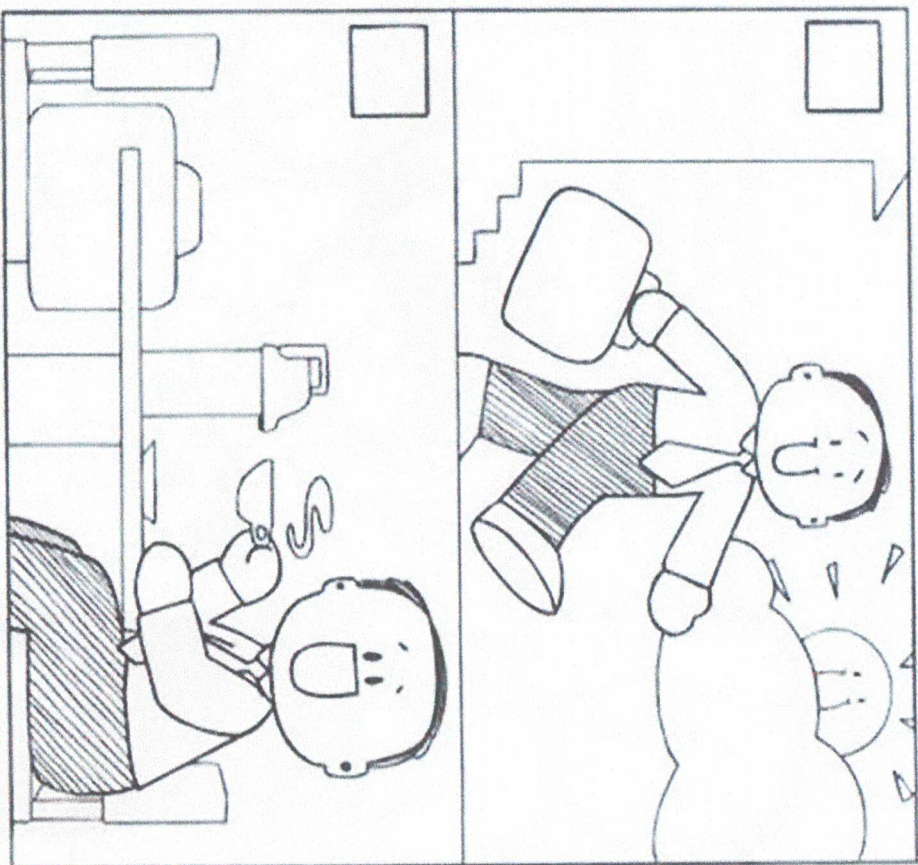
FAÇA UMA + NO PRINCÍPIO DA HISTORINHA
UM / NO FINAL.



 PINTA A CENA.

1º Período - CONHECIMENTO DE MUNDO

COMPLETE OS NOMES DOS DESENHOS COM DA, DE, DI, DO
OU DU.



DO



BO



CABI



CA ADO



DA



IS



DO



NHEIRO



VI



CE

NOME:

IBIÚNA, _____ DE AGOSTO DE _____

16/08/2021

**EU SOU A LETRA D
PARA VOCÊ PEQUENINHO
VOU ENSINAR MEUS PEDACINHOS.**

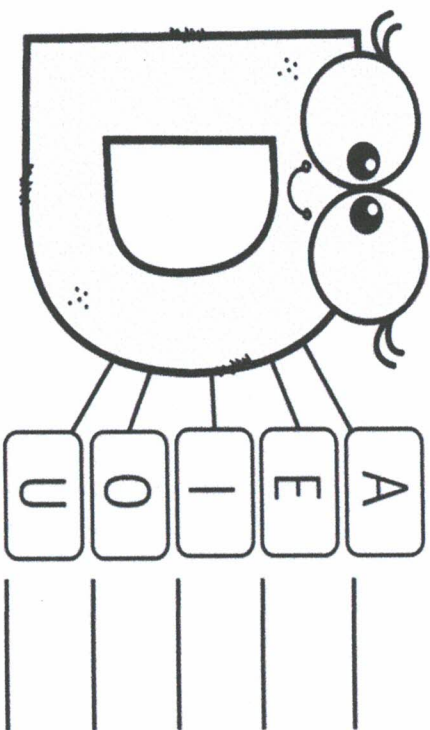



COMPLETE AS PALAVRAS ABAIXO COM AS SILABAS:

DA - DE - DI - DO - DU - DÃO

 _____ DO

 _____ MINÓ

 _____ NOSSAURO

 _____ DO

 _____ CE

 _____ A

JUNTE AS SILABAS E FORME PALAVRAS:

DA + DO _____

DE + DO _____

DO + MI + NÓ _____

DO + CE _____

DI + A _____

DI + NOS + SAU + RO _____



NOME:

IBIÚNA, _____ DE AGOSTO DE _____

17/08/2021

CIRCULE O NOME DAS FIGURAS E COIPE -AS:

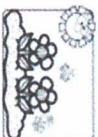
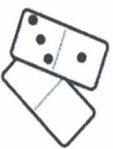
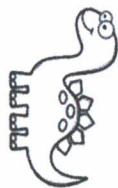
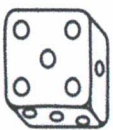

H D A D O K I B U L E O
B A C C A D O C E P N D M
O C C D I A L O I G O M B
M C D O M I N Ó I L L A L
A N B A D E D O E O P A
D I N O S S A U R O I G S

1. LEIA AS PALAVRAS E CIRCULE A LETRA "D":

DOMINÓ DADO DUDU DAMA
DANADA DADÁ DEDO DICA

2. ESCREVA OS NOMES DAS FIGURAS ABAIXO:

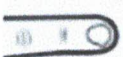

3. COMPLETE COM "DA, DE, DI, DO ou DU"



____ SCO



____ NTE



FA ____



BO ____



____ RMIR



____ REX

NOME:

IBIUNA, _____ DE AGOSTO DE _____

18/08/2021

1. FORME SÍLABAS COM A LETRA F.

www.espacoprofessor.com



FADA

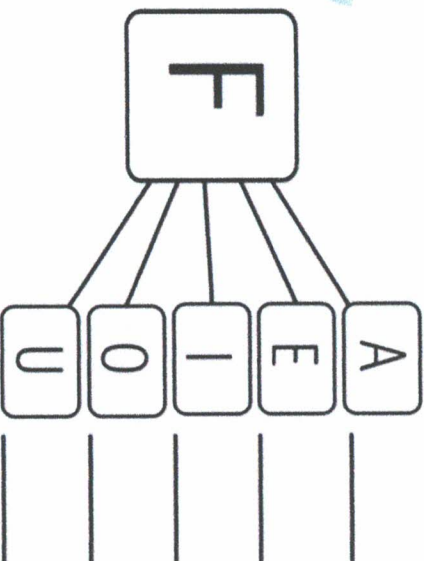

2. COMPLETE AS PALAVRAS COM AS SÍLABAS FALTOSAS E COPIE.



_____ CA



_____ GO

FAMÍLIA SILÁBICA

FA

FE

FI

FO

FU

1. COMPLETE AS PALAVRAS COM O SOM INICIAL:

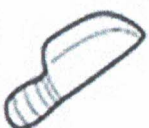

_____ CA

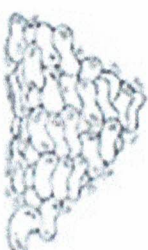

_____ IJÃO



_____ TA



_____ GO



_____ MAÇA

NOME:

IBIÚNA, _____ DE AGOSTO DE _____

19/08/2021

ORDENE AS SILABAS E FORME PALAVRAS.

2	1	3	
A	FI	DO	

2	1	
O	FEI	

1	3	2	
FO	CA	FO	

3	1	4	2	
BA	A	DO	FO	

2	1	
COU	FI	

2	3	1	
MI	GA	FOR	



Cantinho do Saber

BLOG CANTINHO DO SABER

NOME: _____

DATA: ____/____/____

DIA DO FOLCLORE – 22 DE AGOSTO
 NO DIA 22 DE AGOSTO COMEMORAMOS O FOLCLORE BRASILEIRO. FOLCLORE QUER DIZER COSTUMES DE UM POVO: FESTAS, DANÇAS, MÚSICAS, VESTIMENTAS, JOGOS, HISTÓRIAS, LENDAS, BRINCADEIRAS.

OBSERVE ESTES PERSONAGENS DO NOSSO FOLCLORE E PINTE-OS.

IARA



MULA-SEM-CABEÇA



SACI-PERERE



NEGRINHO DO PASTOREIRO



CURUPIRA



NOME:

IBIÚNA, DE AGOSTO DE

20/08/2021

VAMOS COMPLETAR O NOME DOS PERSONAGENS DO FOLCLORE USANDO SOMENTE AS VOGAIS!



L B S M M



C R P R



C C



B T



M L



S C

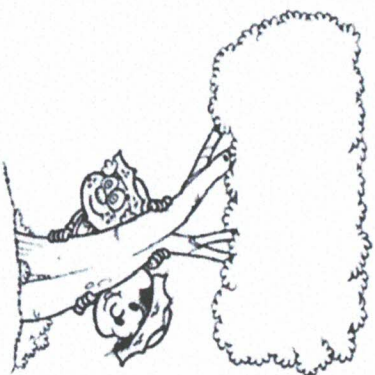

A B I V I N H A S

NOME:

O QUE É, O QUE É?

LEIA, DESENHE E ESCREVA A RESPOSTA:

SOU PEQUENA E LISTRADINHA MORO NA COLMEIA E FAÇO UM GOSTOSO MELZINHO. EU SOU A...

LINDAS TEIAS EU CONSTRUO DURANTE O DIA E À NOITE PARA OS INSETOS ATRAIR. EU SOU A...

VIVO DEBAIXO DA TERRA. ME ESCONDO DOS PASSARINHOS. MUITOS ME USAM COMO ESCA PARA PEGAR OS PEIXINHOS. QUEM SOU?

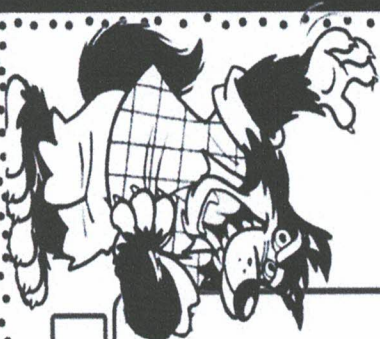

NOME:

IBIÚNA,

DE AGOSTO DE

23/08/2021

TABELA

CONTE A QUANTIDADE E COMPLETE A TABELA:



Atividades Suzano

TABELA – PERSONAGENS	
PERSONAGENS	QUANTIDADE
IAPA	
LOBISOMEM	
CUCA	
Negrinho do pastoreio	

PERSONAGEM COM MAIS QUANTIDADE

ATIVIDADE

OLHE BEM! PRESTE ATENÇÃO! QUANTOS SACIZINHOS ESTÃO POR AQUI?

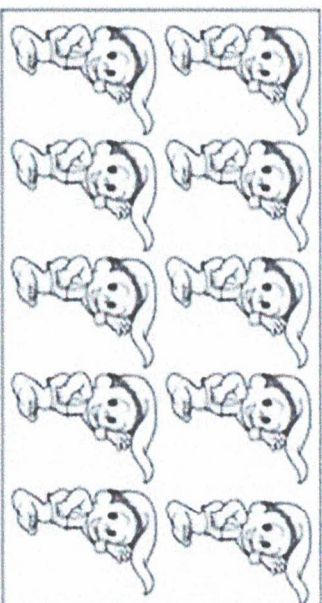

EM UMA VIAGEM DE CHARRETE ESTAVAM 7 SACIZINHOS, 4 ACABARAM PULANDO FORA EM UMA CURVA DO CAMINHO.

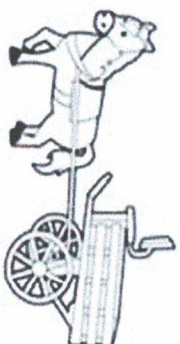

QUANTOS SACIZINHOS SOBRRARAM NA CHARRETE?

NOME:

IBIÚNA, _____ DE AGOSTO DE _____

24/08/2021

COMPLETE OS NUMERAIS ATÉ O SACI CHEGAR A GARRAFA PARA
PRENDÊ-LO.

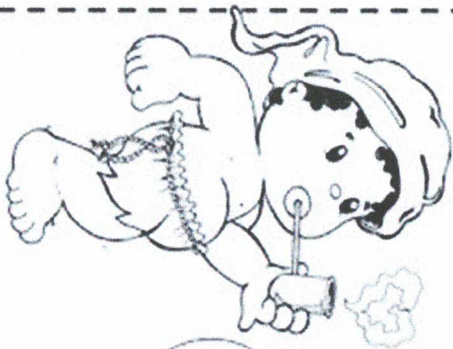

1

2

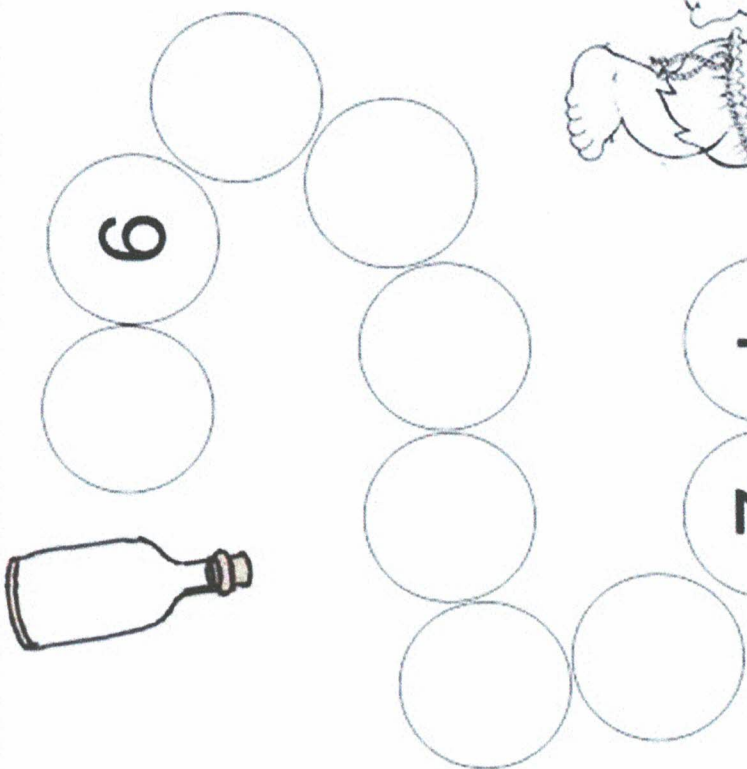

OBSEVE A IMAGEM ACIMA

1- Quantos personagens de lendas folclóricas você vê
na imagem? Escreva seus nomes:

Observe a palavra abaixo

CURUPIRA

Quantas letras tem essa palavra?

Quantas sílabas?











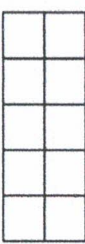

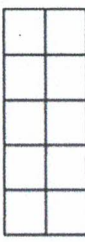

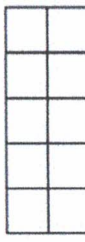

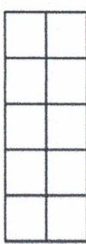
Escreva três palavras com a mesma inicial da palavra acima:

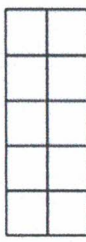
NOME:

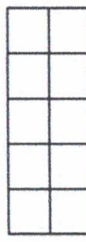
IBIUNA, _____ DE AGOSTO DE _____

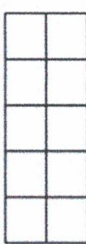
25/08/2021

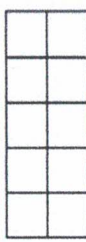

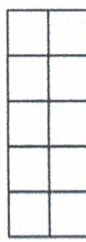



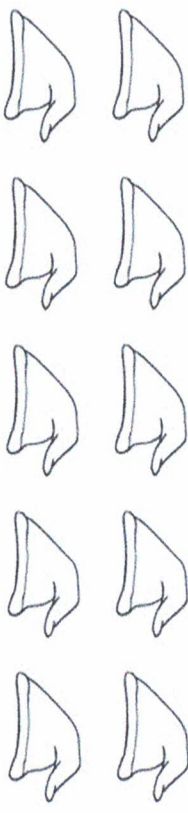





































CONTANDO COM A IARA

 9 	 2 	 6 
 1 	 8 	 3 
 5 	 4 	 7 

VAMOS ESCREVER OS NÚMEROS DE 0 A 9 DENTRO DOS GORROS:



VAMOS PINTAR A QUANTIDADE INDICADA :

5									
6									
7									
8									
9									



NOME:

IBIÚNA, _____ DE AGOSTO DE _____

26/08/2021

Ligue os pontos seguindo a ordem
crescente dos numerais:

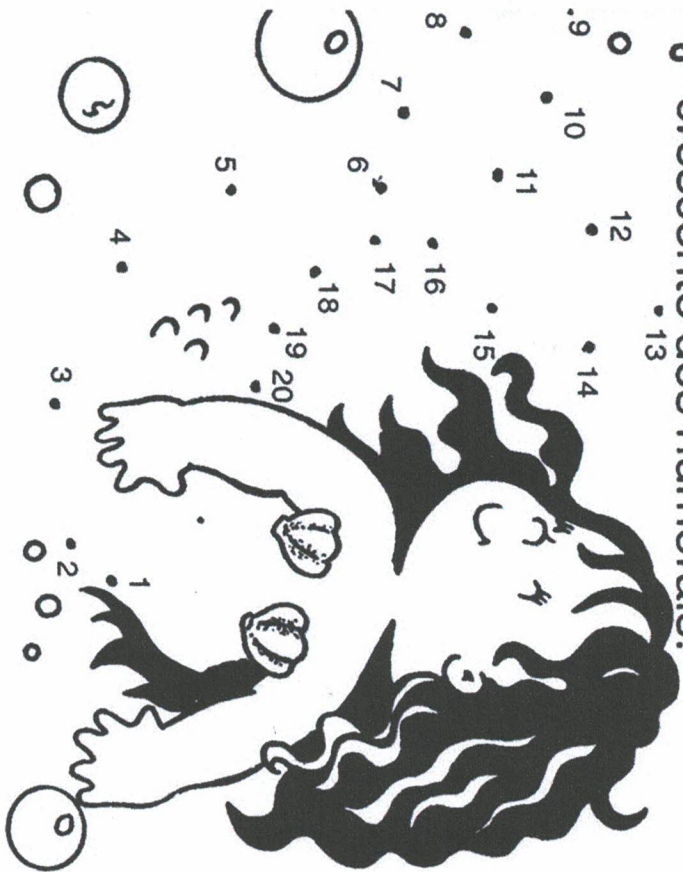

www.dessiral.blogspot.com

ATIVIDADE
AJUDE IARA A ESCOLHER O ESPELHO MAIOR.

RECORTE E COLE NO ESPELHO DE IARA PALAVRAS INICIADAS
PELA LETRA E.

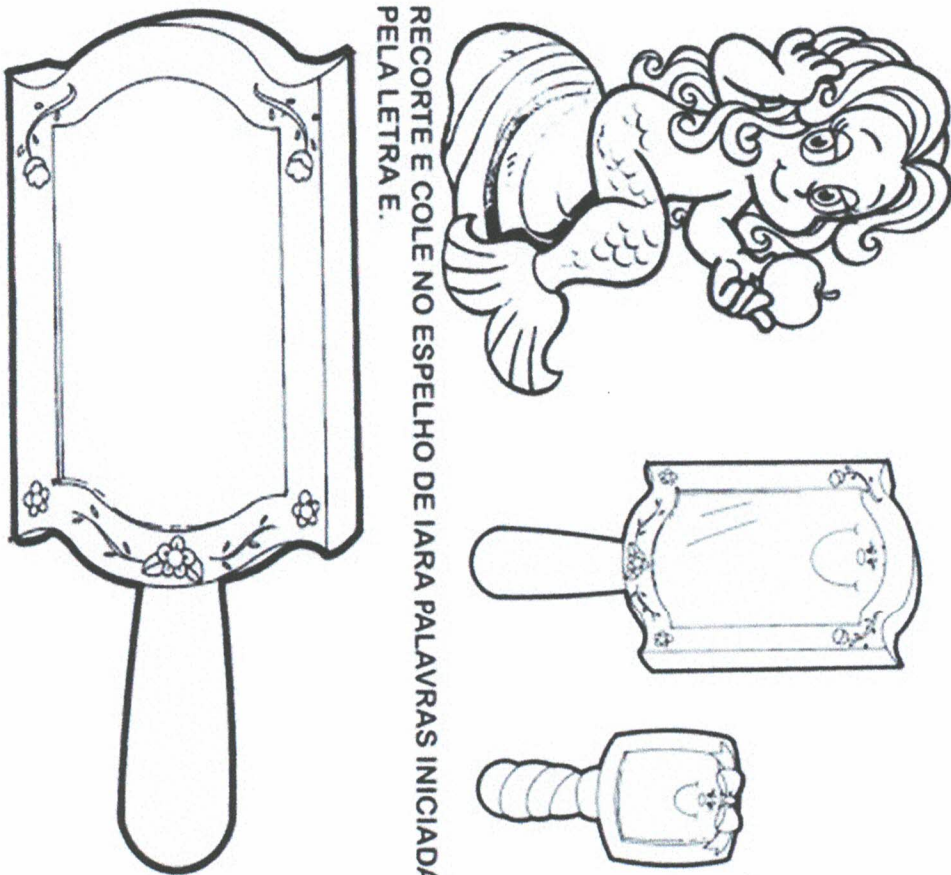

www.dessiral.blogspot.com

NOME:

IBIÚNA, _____ DE AGOSTO DE _____

27/08/2021

ATIVIDADES FOLCLÓRICAS



CURUPIRA

SEGUNDO AS LENDAS, O CURUPIRA É UM PROTETOR DAS MATAS E DOS ANIMAIS. ELE É REPRESENTADO POR UM ANÃO DE CABELOS COMPRIDOS E COM OS PÉS VIRADOS PARA TRÁS.

DESENHE O QUE ENCONTRAMOS NAS FLORESTAS:

SE CADA SACIZINHO COMER 2 BISCOITOS QUANTOS BISCOITOS ELES COMERÃO JUNTOS?

ATIVIDADE

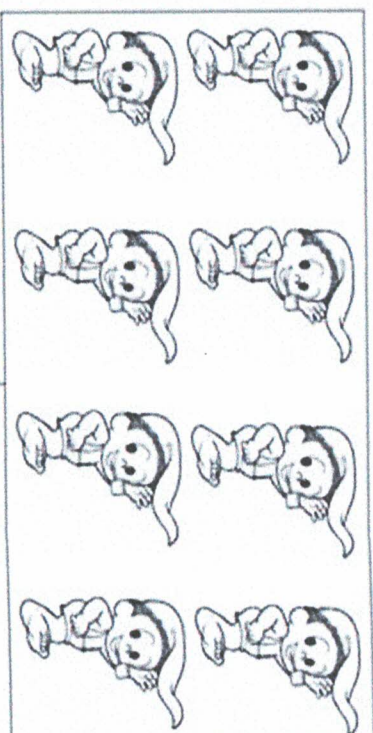



DOBRADURA DO SACI.

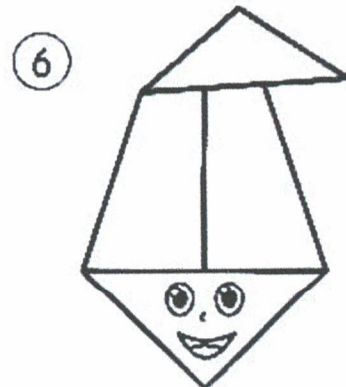
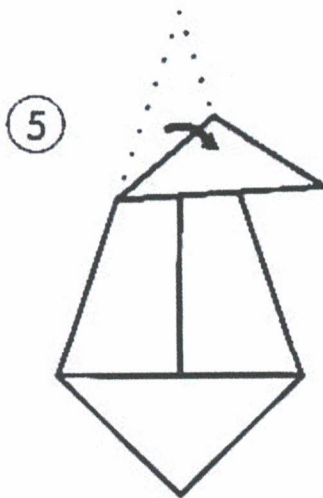
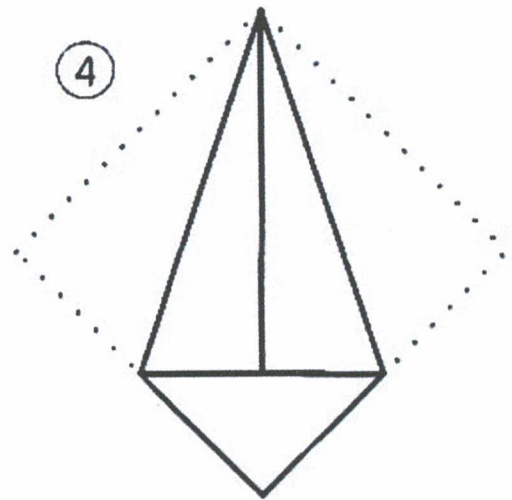
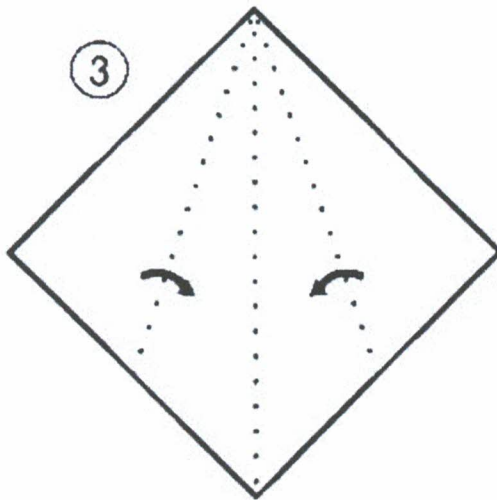
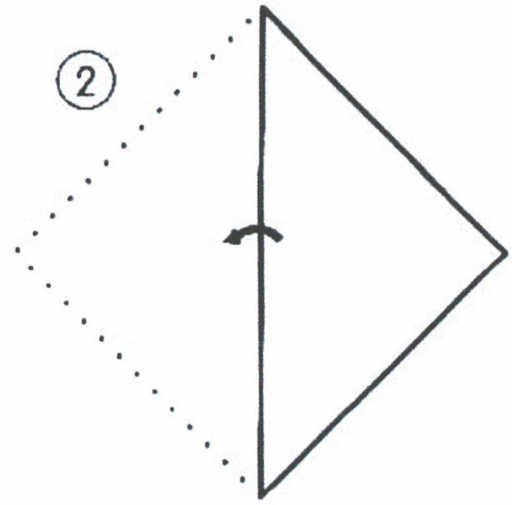
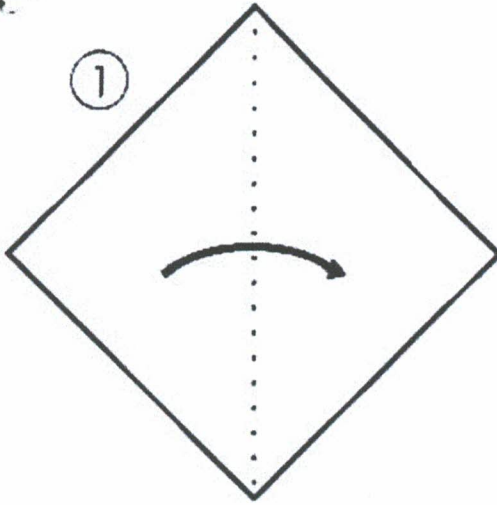

COM O PAPEL DOBRADURA MONTE A CABEÇA DO SACI E COLE AQUI.

