

E.M. "PADRE ELÍDIO MANTOVANI"

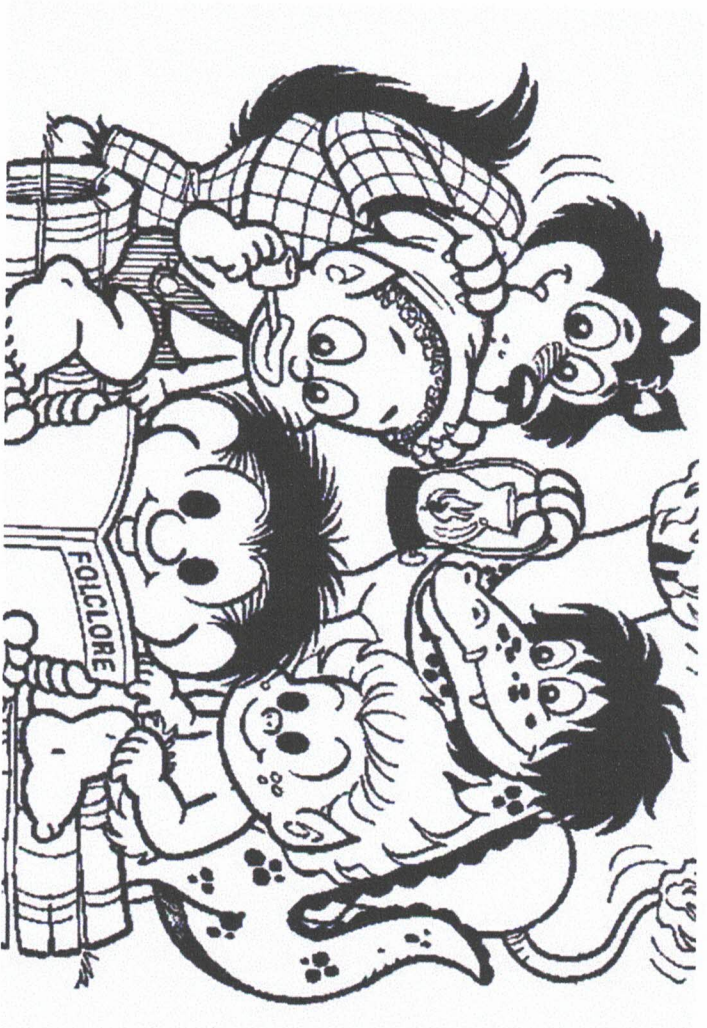

NOME: _____

1º ANO C PROFESSORA SILVANEIDE

ATIVIDADES DE 09/08/21 À 27/08/2021

DEVOLUÇÃO: 30/08/2021

NOME:

IBIJUNA, _____ DE AGOSTO DE _____

10/08/2021

P
A
P
A
I



O SEU NOME É _____

COLE A FOTO DELE AQUI

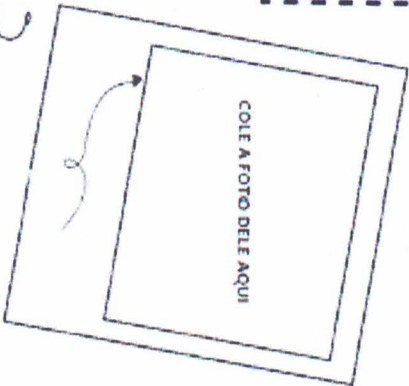
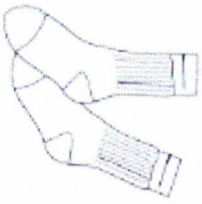

SUA COR FAVORITA É _____

SUA COMIDA FAVORITA É _____

EU GOSTO DE MEU PAI PORQUE _____

www.educacaotrasmformacao.com.br



VAMOS CONTAR AS ROUPAS DO PAPAII

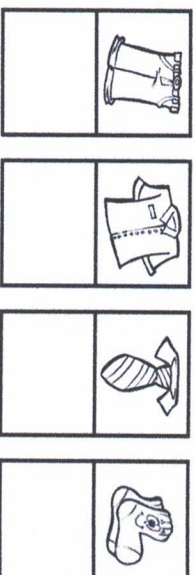
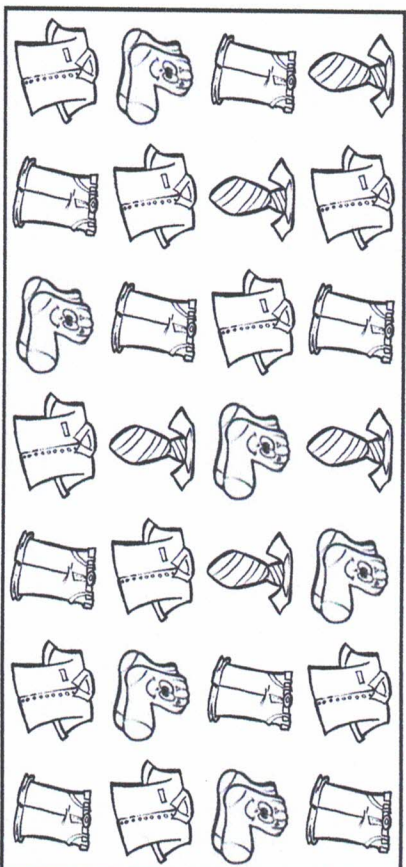

QUAL PEÇA DE ROUPA O PAPAII TEM MAIS? _____

QUAL PEÇA DE ROUPA O PAPAII TEM MENOS? _____

www.educacaotrasmformacao.com.br

NOME:

IBIJUNA, _____ DE AGOSTO DE _____

11/07/2021

DIA DOS PAIS ADIVINHAS

O QUE É O QUE É...
O PAPAÍ...

- 1-USA NO INVERNO:
- () CASACO
 - () SAIA
 - () SORVETE

- 2-USA COM OS SAPATOS:
- () TOUCA
 - () MEIA
 - () LUVIA

- 3-USA NA CABEÇA:
- () CAMISETA
 - () CASACO
 - () TOUCA



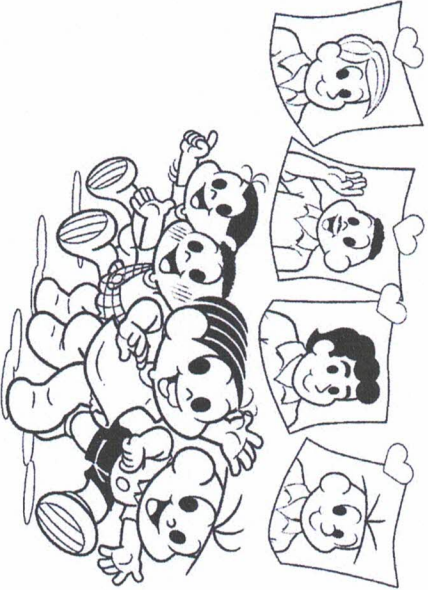

- 4-USA NA CINTURA:
- () CHAPÉU
 - () CINTO
 - () BONÉ

- 5-USA PARA ESQUENTAR O PESCOÇO NO INVERNO:
- () CACHECOL
 - () CAMISA
 - () MEIA



AS COISAS DO PAPAÍ

VEJA AS QUANTIDADES:

			
BONÉS 6	CAMISAS 12	CALÇAS 15	CINTOS 4

REPRESENTE NO GRÁFICO:

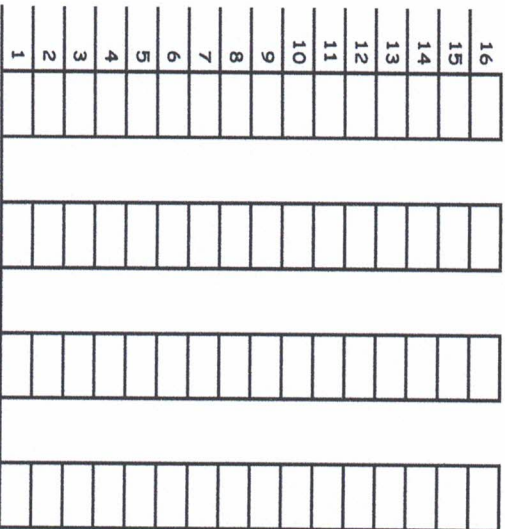

CINTOS BONÉS CAMISAS CALÇAS



NOME:

IBIJUNA, _____ DE AGOSTO DE _____

12/08/2021

1- ENCONTRE E PINTE A PALAVRA PAI NO TEXTO ABAIXO:

**MEU PAI, MEU AMIGO,
FIEL COMPANHEIRO,
EXEMPLO VERDADEIRO,
PARA MIM...**

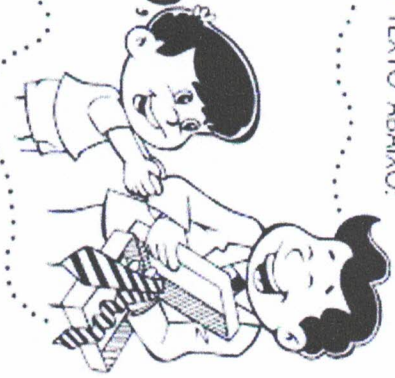

MUSICA CRISTINA MEL

2- MEU PAI COMPLETOU UMA DÚZIA DE GRAVATAS EM SUA COLEÇÃO. QUAL NUMERAL REPRESENTA UMA DÚZIA?

3- COMPLETE A SEQUÊNCIA NUMÉRICA NAS GRAVATAS DO PAPAI.

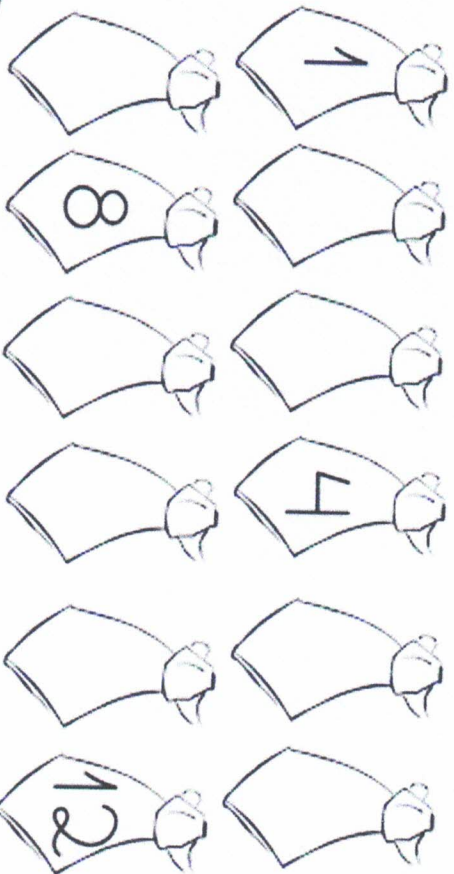

www.aartedeensinareaprender.com

ATIVIDADE



PAPAI PRECISA DE 2 DOS OBJETOS DE CADA QUADRO EM SUA MALA. AJUDE-O PINTANDO A QUANTIDADE CORRETAMENTE.

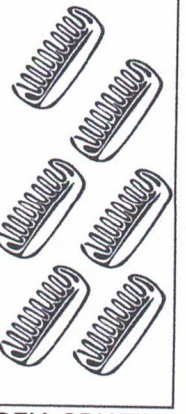
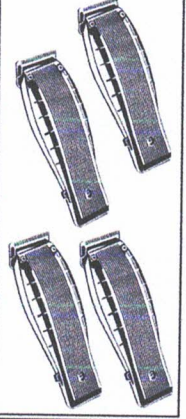
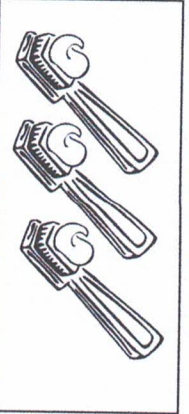
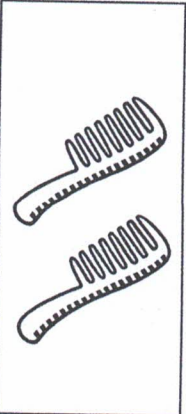
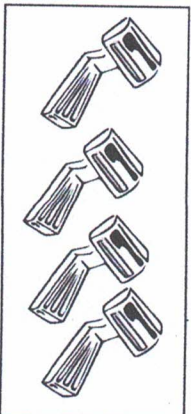
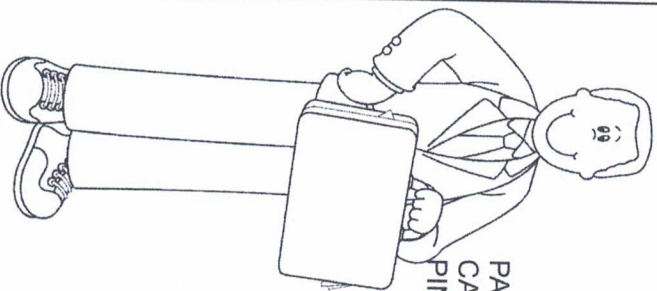

IDEIA CRIATIVA

ESCOLA MUNICIPAL "PADRE ELÍDIO MANTOVANI"

NOME:

IBIÚNA, _____ DE AGOSTO DE _____

13/08/2021

PAPAI MORA EM MEU CORAÇÃO.
PINTE AS VOGAIS DO NOME PAI.

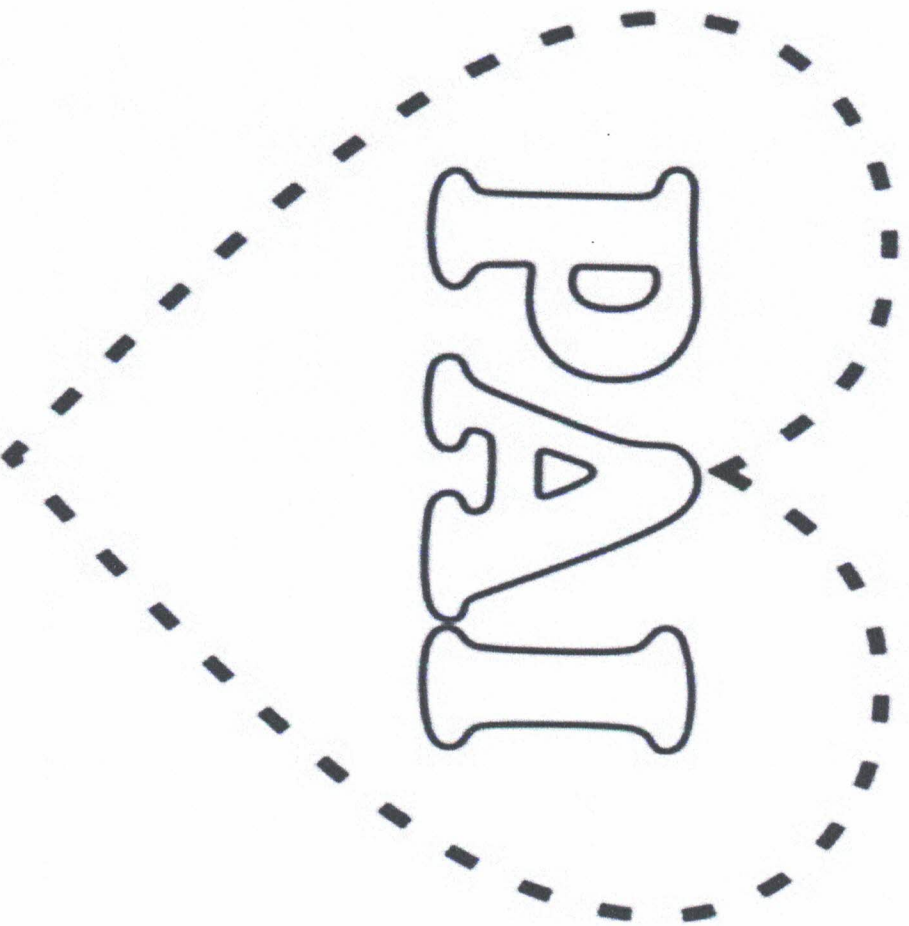

MEU PRESENTE PARA O PAPAII!
PINTE OS PRESENTES QUE VOCÊ GOSTARIA
DE DAR PARA O SEU PAPAII!

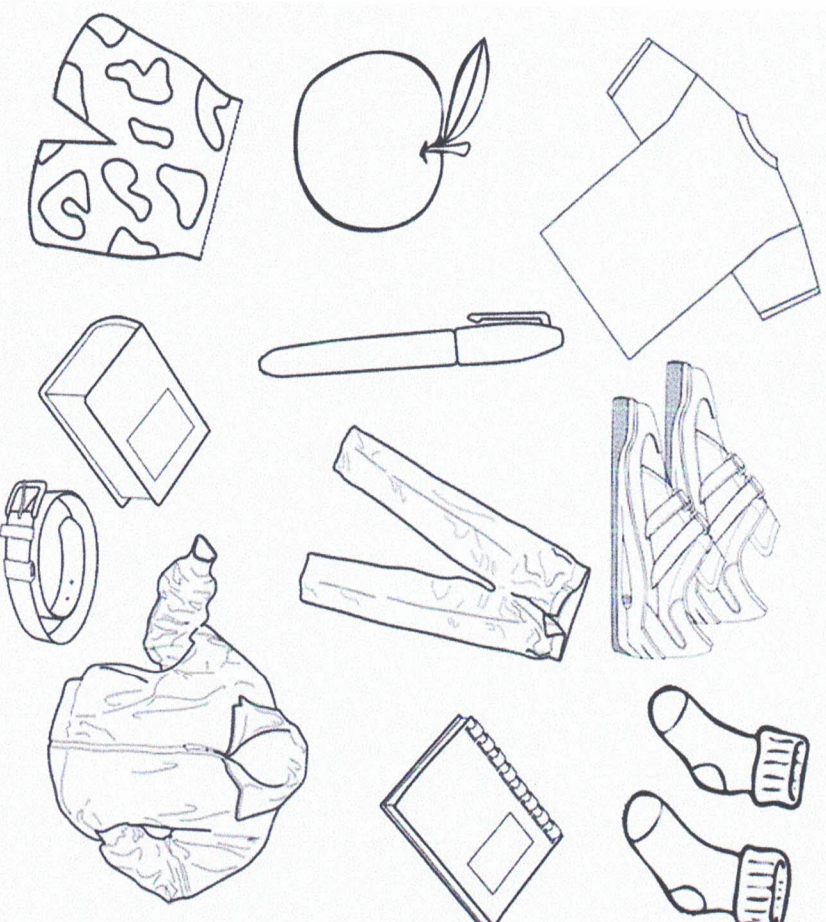

NOME:

IBIÚNA, _____ DE AGOSTO DE _____

14/08/2021

 FAÇA UMA + NO PRINCÍPIO DA HISTORINHA
UM / NO FINAL.

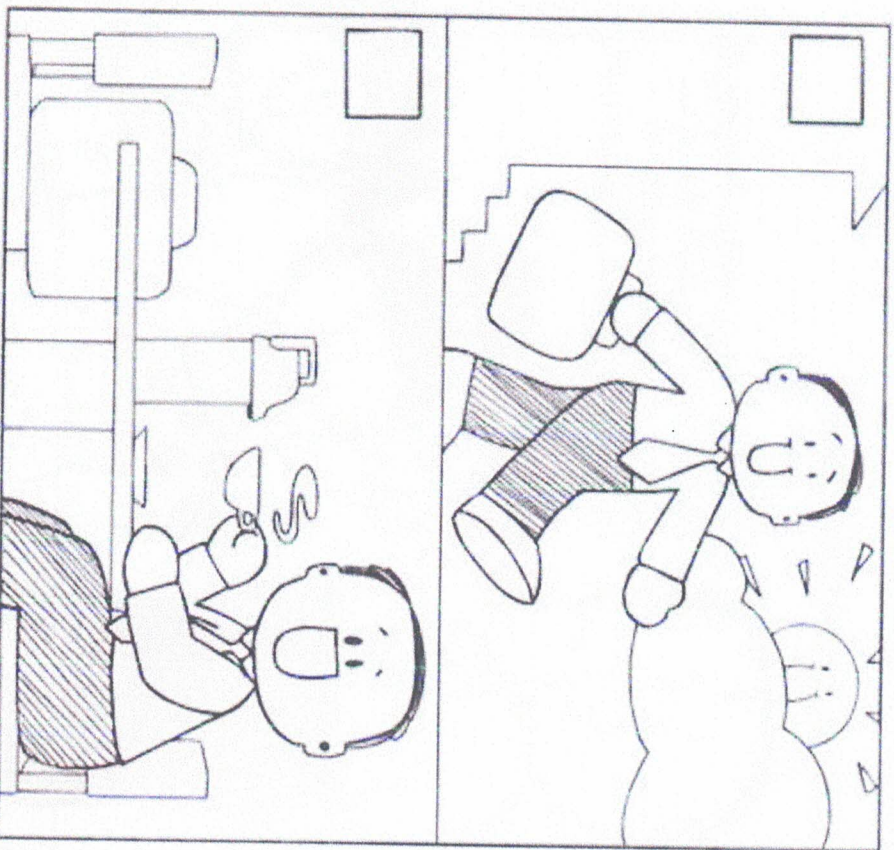

 PINTE A CENA.

1º Período - CONHECIMENTO DE MUNDO

 COMPLETE OS NOMES DOS DESENHOS COM DA, DE, DI, DO
OU DU.

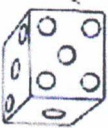

DO



BO

CABI

CA ADO

DA

IS

DO

NHEIRO

VI



CE

NOME:

IBIÚNA, _____ DE AGOSTO DE _____

16/08/2021

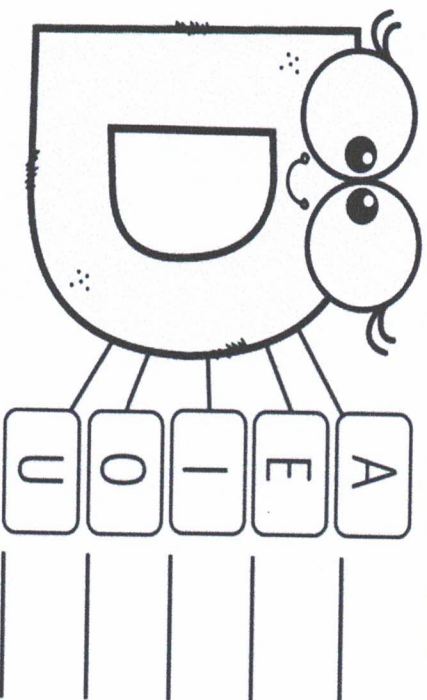
EU SOU A LETRA D
PARA VOCÊ PEQUENININHO
VOU ENSINAR MEUS PEDACINHOS.



COMPLETE AS PALAVRAS ABAIXO COM AS SÍLABAS:

DA - DE - DI - DO - DU - DÃO

 _____ DO

 _____ MINÓ

 _____ A

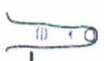
 _____ DO

 _____ CE

 _____ NOSSAURO

[HTTPS://ATIVIDADESPARABAIXAR.COM/](https://atividadeparabaixar.com/)



JUNTE AS SÍLABAS E FORME PALAVRAS:

DA + DO _____

DE + DO _____

DO + MI + NÓ _____

DO + CE _____

DI + A _____

DI + NOS + SAU + RO _____

[HTTPS://ATIVIDADESPARABAIXAR.COM/](https://atividadeparabaixar.com/)



NOME:

IBIÚNA, _____ DE AGOSTO DE _____

17/08/2021

CIRCULE O NOME DAS FIGURAS E COIPE -AS:

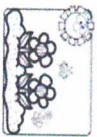
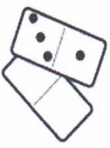
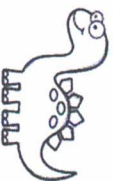
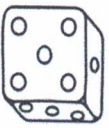

H D A D O K I B U L E O
B A C A D O C E P N D M
O C C D I A L O I G O M B
M C D D O M I N Ó I L L A L
A N B A D E D O E O P A
D I N O S S A U R O I G S

1. LEIA AS PALAVRAS E CIRCULE A LETRA "D":

DOMINÓ DADO DUBU DAMA
DANADA DADÁ DEDO DICA

2. ESCREVA OS NOMES DAS FIGURAS ABAIXO:

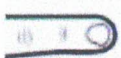

3. COMPLETE COM "DA, DE, DI, DO ou DU"

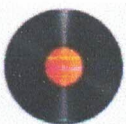

SCO _____



NTE _____



FA _____



BO _____



RMIR _____



REX _____

NOME:

IBIÚNA, _____ DE AGOSTO DE _____

18/08/2021

1. FORME SÍLABAS COM A LETRA F.

www.espacoProfessor.com



FADA

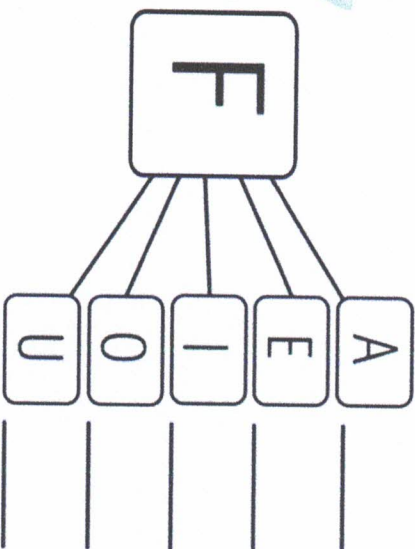

2. COMPLETE AS PALAVRAS COM AS SÍLABAS FALTOSAS E COPIE.



____ CA

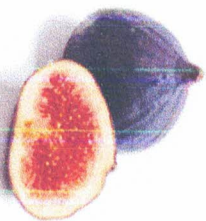

____ GO

FAMÍLIA SILÁBICA

FA FE FI FO FU

1- COMPLETE AS PALAVRAS COM O SOM INICIAL.



CA

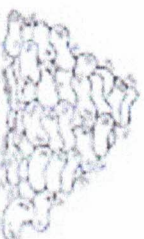

IÃO



TA



GO



MAÇA

ESCOLA MUNICIPAL "PADRE ELÍDIO MANTOVANI"

NOME:

IBIÚNA, _____ DE AGOSTO DE _____

19/08/2021

ORDENE AS SILABAS E FORME PALAVRAS.

2	1	3	
A	FI	DO	

2	1	
O	FEI	

1	3	2	
FO	CA	FO	

3	1	4	2	
BA	A	DO	FO	

2	1	
COU	FI	

2	3	1	
MI	GA	FOR	



Cantinho do Saber



BLOG CANTINHO DO SABER

NOME: _____

DATA: ____/____/____

DIA DO FOLCLORE – 22 DE AGOSTO

NO DIA 22 DE AGOSTO COMEMORAMOS O FOLCLORE BRASILEIRO. FOLCLORE QUER DIZER COSTUMES DE UM POVO: FESTAS, DANÇAS, MÚSICAS, VESTIMENTAS, JOGOS, HISTÓRIAS, LENDAS, BRINCADEIRAS.

OBSERVE ESTES PERSONAGENS DO NOSSO FOLCLORE E PINTE-OS.

IARA

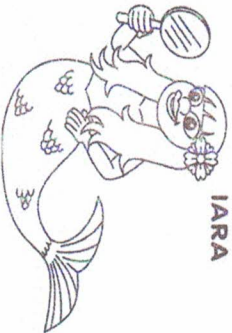

MULA-SEM-CABEÇA

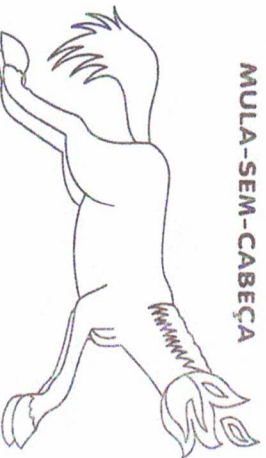

SACI-PERERÊ



NEGRINHO DO PASTOREIRO



CURUPIRA

ESCOLA MUNICIPAL "PADRE ELDIO MANTOVANI"

NOME:

IBIUNA, _____ DE AGOSTO DE _____

20/08/2021

VAMOS COMPLETAR O NOME DOS PERSONAGENS DO FOLCLORE USANDO SOMENTE AS VOGAIS!



L B S M M



C R P R



C C



B T



M L



S C

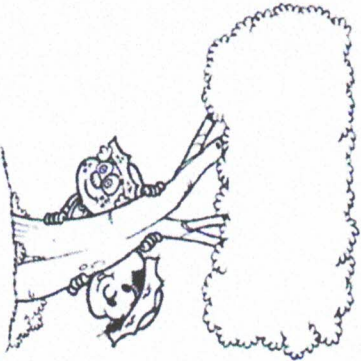

ADIVINHAS

O QUE É, O QUE É?

LEIA, DESENHE E ESCREVA A RESPOSTA:

SOU PEQUENA E LISTRADINHA MORO NA COLMEIA E FAÇO UM GOSTOSO MELZINHO. EU SOU A...

LINDAS TEIAS EU CONSTRUO DURANTE O DIA E A NOITE PARA OS INSETOS ATRAIR. EU SOU A...

VIVO DEBAIXO DA TERRA. ME ESCONDO DOS PASSANTINHOS. TODOS ME USAM COMO ISCA PARA PEGAR OS PEIXINHOS. QUEM SOU?



TABELA

CONTE A QUANTIDADE E COMPLETE A TABELA:

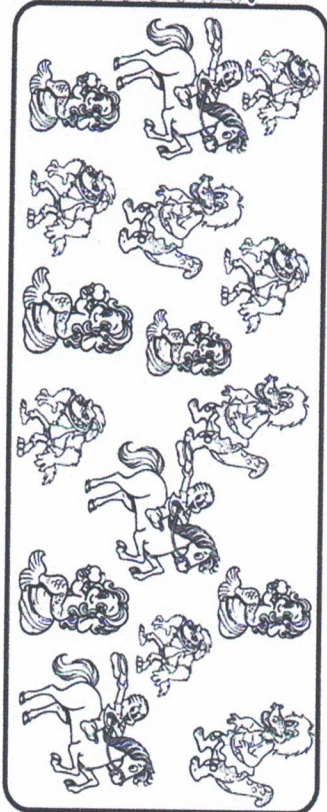

Atividades Suzano

TABELA – PERSONAGENS	
PERSONAGENS	QUANTIDADE
IAPA	
LOBISOMEM	
CUCA	
Negrinho do Pastoreio	

PERSONAGEM COM MAIS QUANTIDADE

ATIVIDADE

OLHE BEM! PRESTE ATENÇÃO! QUANTOS SACIZINHOS ESTÃO POR AQUI?

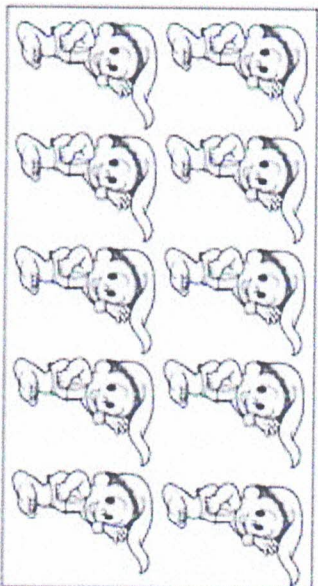

EM UMA VIAGEM DE CHARRETE ESTAVAM 7 SACIZINHOS. 4 ACABARAM PULANDO FORA EM UMA CURVA DO CAMINHO.

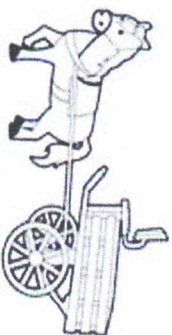

QUANTOS SACIZINHOS SOBRRARAM NA CHARRETE?

ESCOLA MUNICIPAL "PADRE ELÍDIO MANTOVANI"

NOME:

IBIÚNA, _____ DE AGOSTO DE _____

24/08/2021

COMPLETE OS NUMERAIS ATÉ O SACI CHEGAR A GARRAFA PARA
PRENDÊ-LO.



1

2

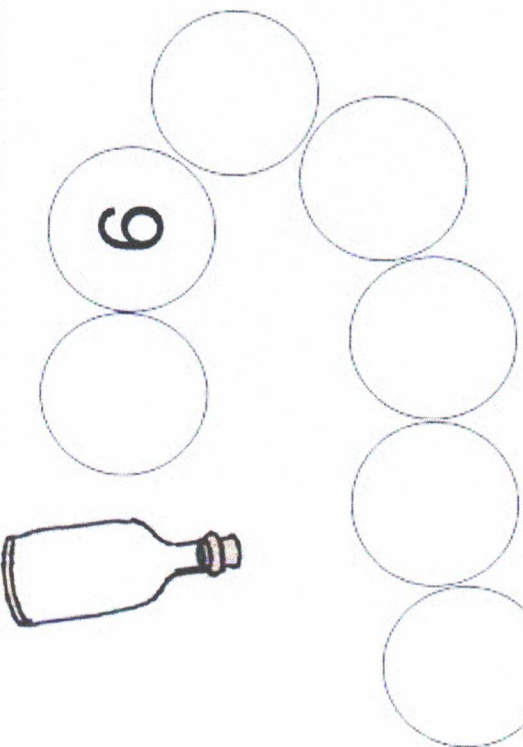

Dani Educar

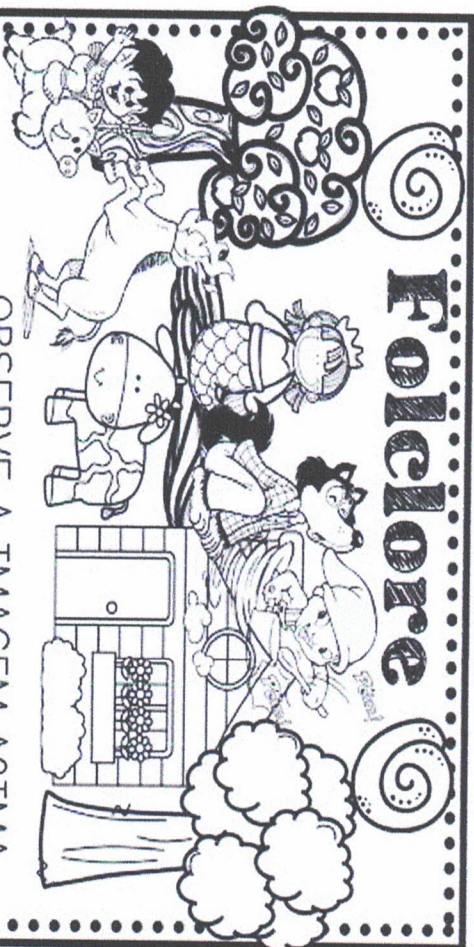

Folclore

OBSERVE A IMAGEM ACIMA

1- Quantos personagens de lendas folclóricas você vê
na imagem? Escreva seus nomes:

Observe a palavra abaixo:

CURUPIRA

Quantas letras tem essa palavra?

Quantas sílabas?

Escreva três palavras com a mesma inicial da palavra acima:













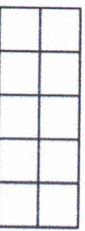

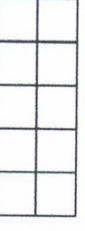

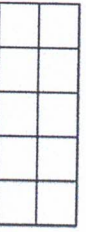
@professoranayarah

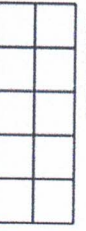
NOME:

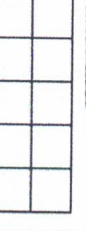
IBIÚNA, _____ DE AGOSTO DE _____

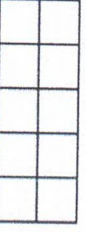
25/08/2021

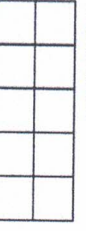
CONTANDO COM A IARA

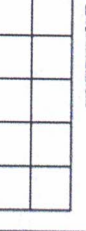
 9 	 2 	 6 
 1 	 8 	 3 
 5 	 4 	 7 

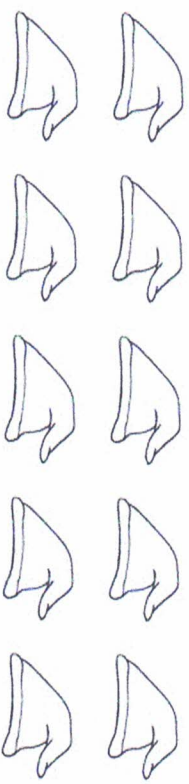

VAMOS ESCREVER OS NÚMEROS DE 0 A 9 DENTRO DOS GORROS:

VAMOS PINTAR A QUANTIDADE INDICADA :

5											
6											
7											
8											
9											



Ligue os pontos seguindo a ordem

o crescente dos numerais:

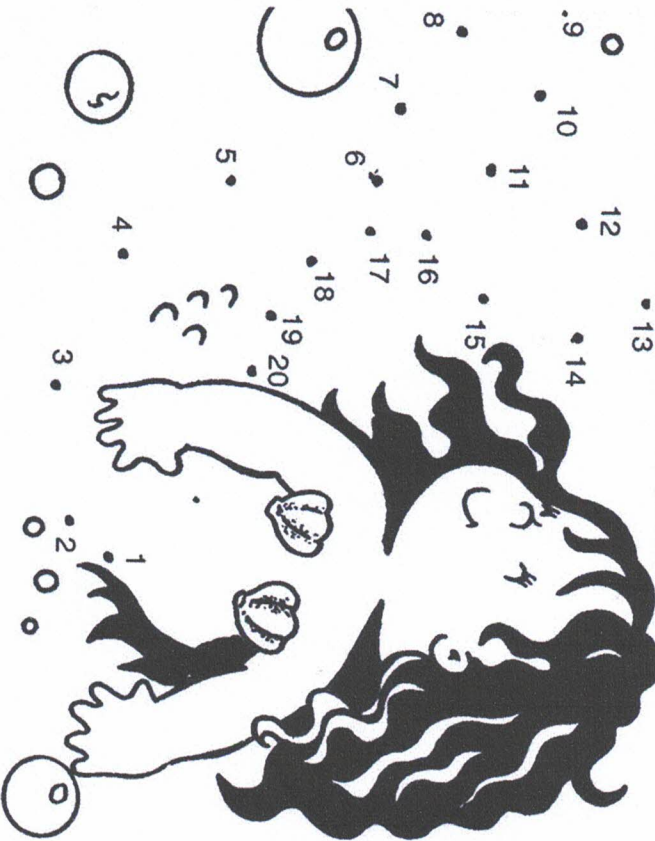

ATIVIDADE

AJUDE IARA A ESCOLHER O ESPELHO MAIOR.

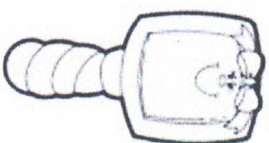
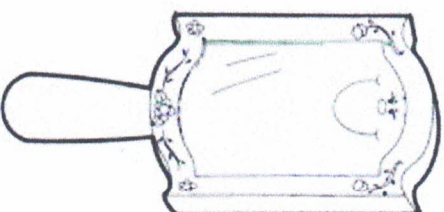

RECORTE E COLE NO ESPELHO DE IARA PALAVRAS INICIADAS PELA LETRA E.

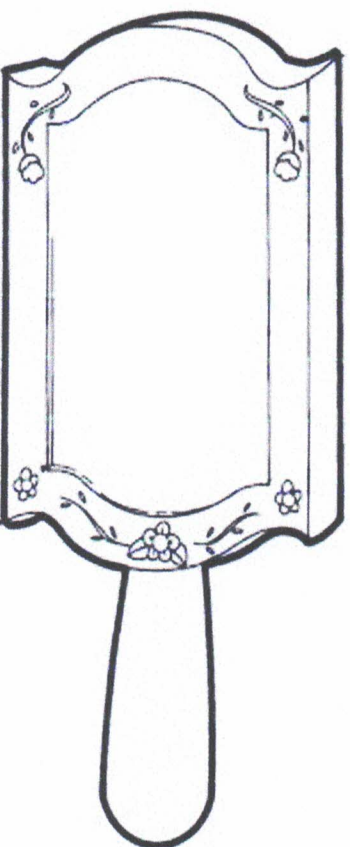

ESCOLA MUNICIPAL "PADRE ELÍDIO MANTOVANI"

NOME:

IBIJUNA, _____ DE AGOSTO DE _____

27/08/2021

ATIVIDADES FOLCLÓRICAS



CURUPIRA

SEGUNDO AS LENDAS, O CURUPIRA É UM PROTETOR DAS MATAS E DOS ANIMAIS. ELE É REPRESENTADO POR UM ANÃO DE CABELOS COMPRIDOS E COM OS PÉS VIRADOS PARA TRÁS.

DESENHE O QUE ENCONTRAMOS NAS FLORESTAS:

ATIVIDADE

SE CADA SACIZINHO COMER 2 BISCOITOS QUANTOS BISCOITOS ELES COMERÃO JUNTOS?

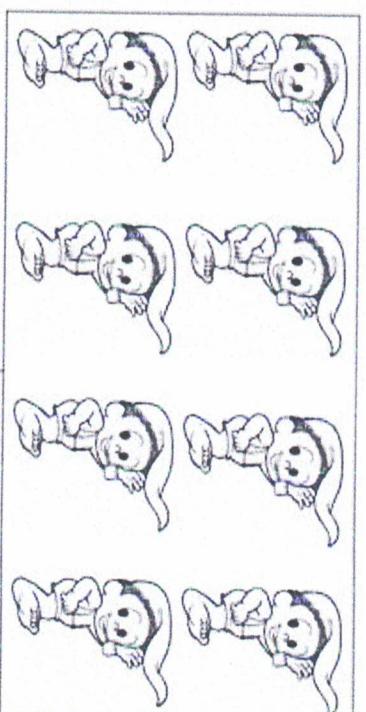

3 DOBRADURA DO SACI.

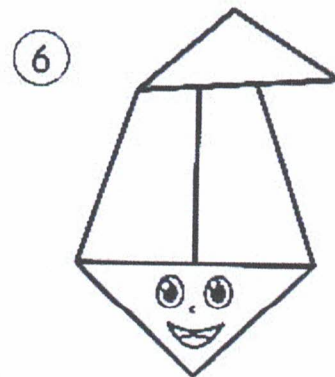
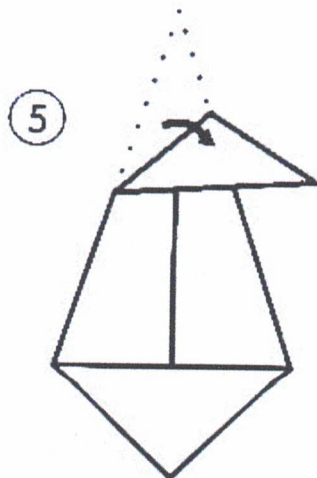
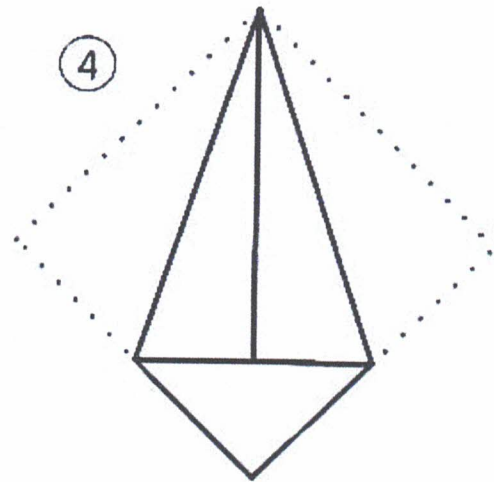
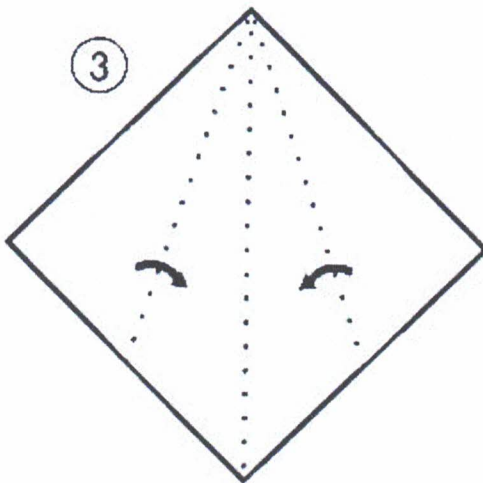
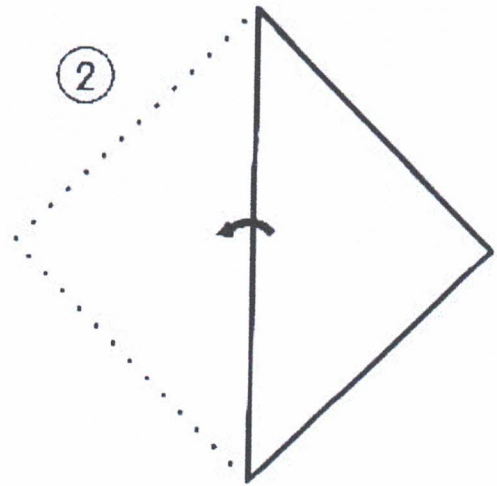
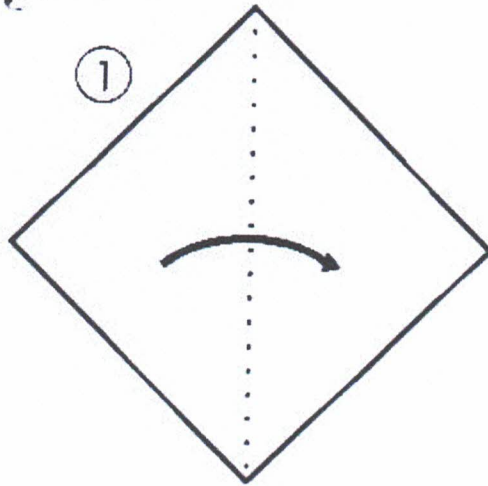

COM O PAPEL DOBRADURA MONTE A CABEÇA DO SACI E COLE AQUI.

