



PREFEITURA DA ESTÂNCIA TURÍSTICA DE
IBIÚNA
Por uma Ibiúna próspera. Investindo no presente. gerando o futuro.
SECRETARIA DE EDUCAÇÃO



E.M. "MARIA APARECIDA GABRIEL CARDOSO"

PROFESSORA: MARCIA

ALUNO:

ANO/SÉRIE: FASE I A – 9ª APOSTILA

MINHAS ATIVIDADES

ATIVIDADES RETIRADAS EM 10/08/2021

Referente aos dias: 09, 10, 11, 12, 13, 14, 16, 17, 18, 19, 20, 23, 24, 25, 26 e 27/08.

DEVOLUÇÃO EM 30/08/2021



TOBAS AS ATIVIDADES DEVEM SER REALIZADAS DE ACORDO COM AS DATAS INDICADAS NAS FOLHAS DE EXERCÍCIOS.

PARTICIPEM DOS GRUPOS DE WHATSAPP SEMPRE QUE POSSÍVEL.



COMPLETE O PONTILHADO DO DESENHO

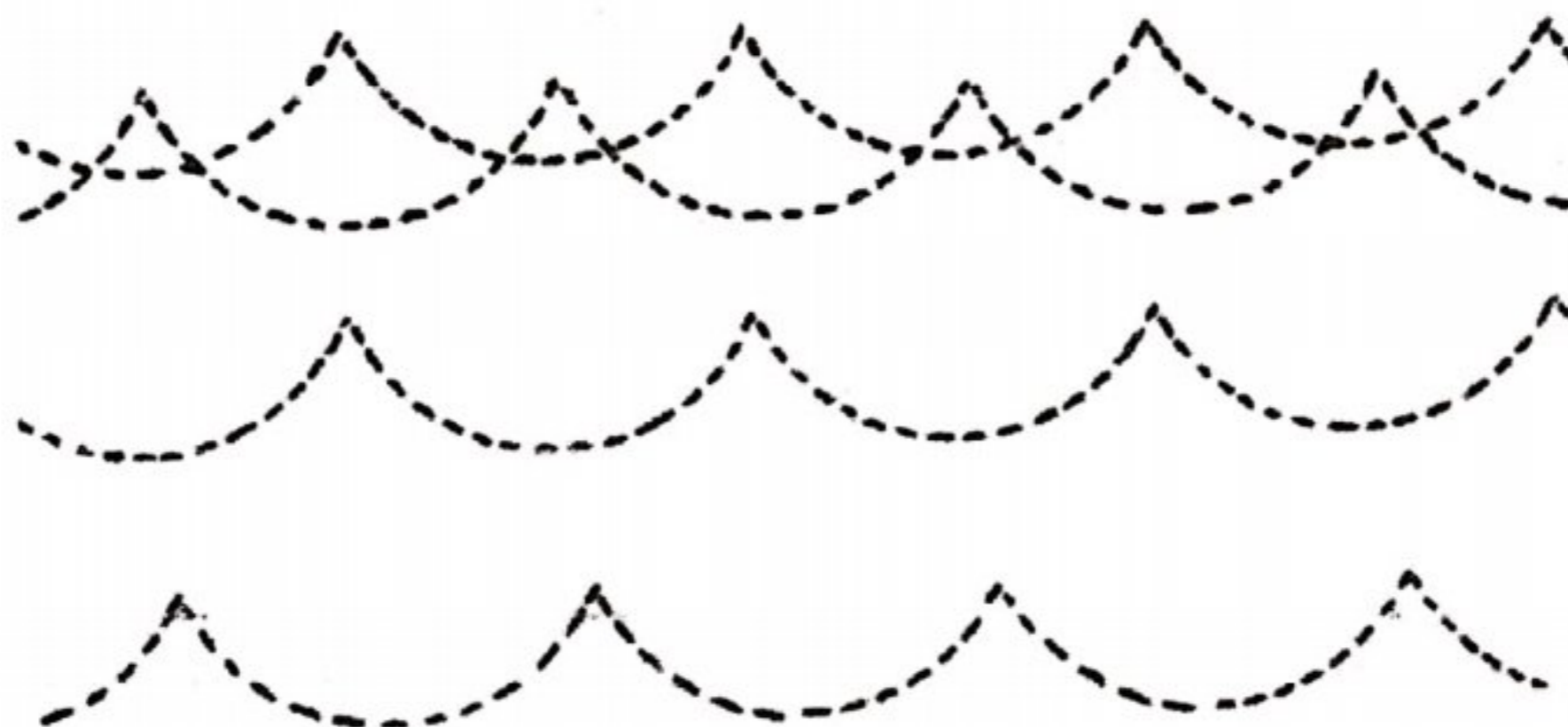
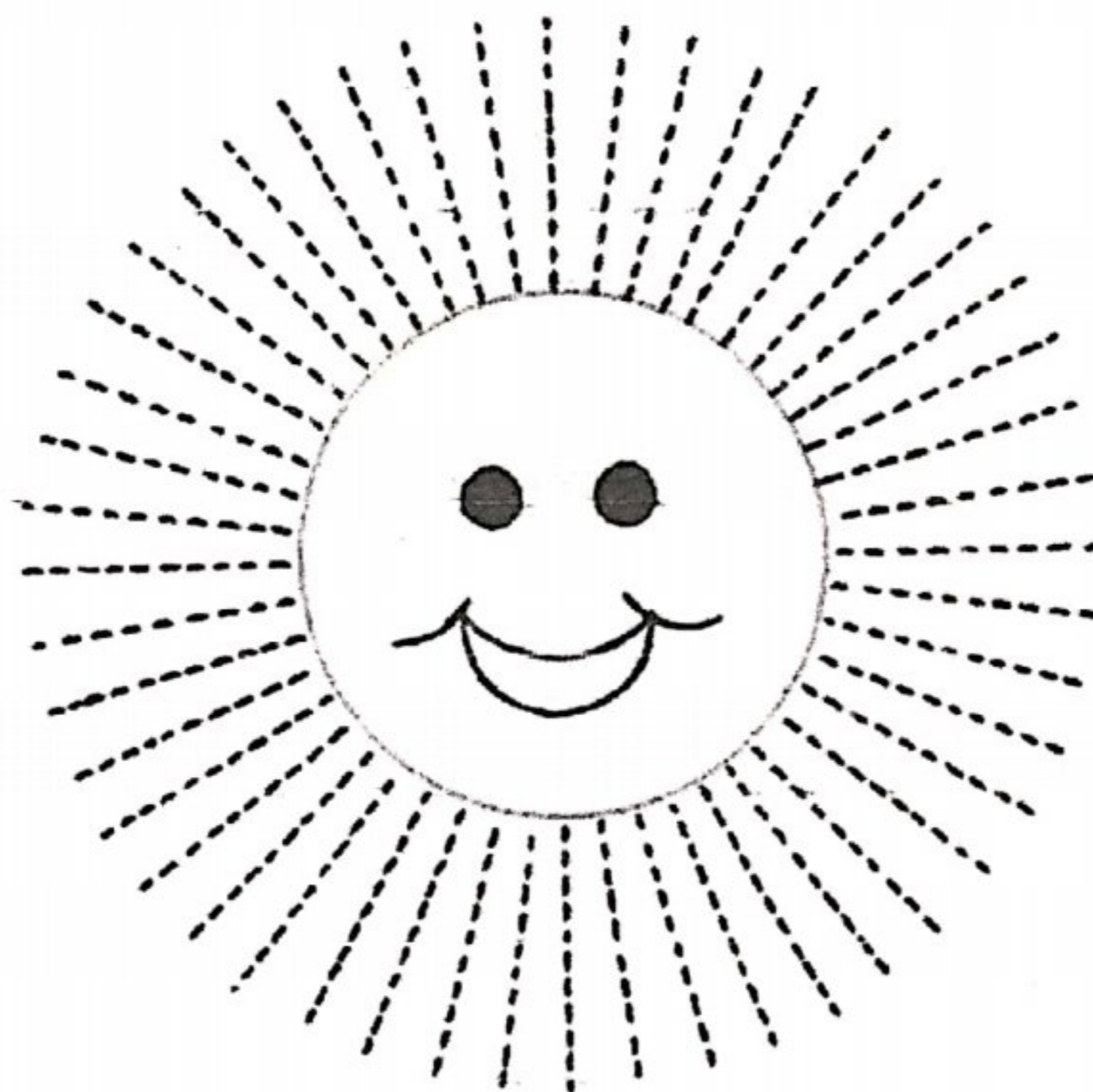

COMPLETE O PONTILHADO DO DESENHO

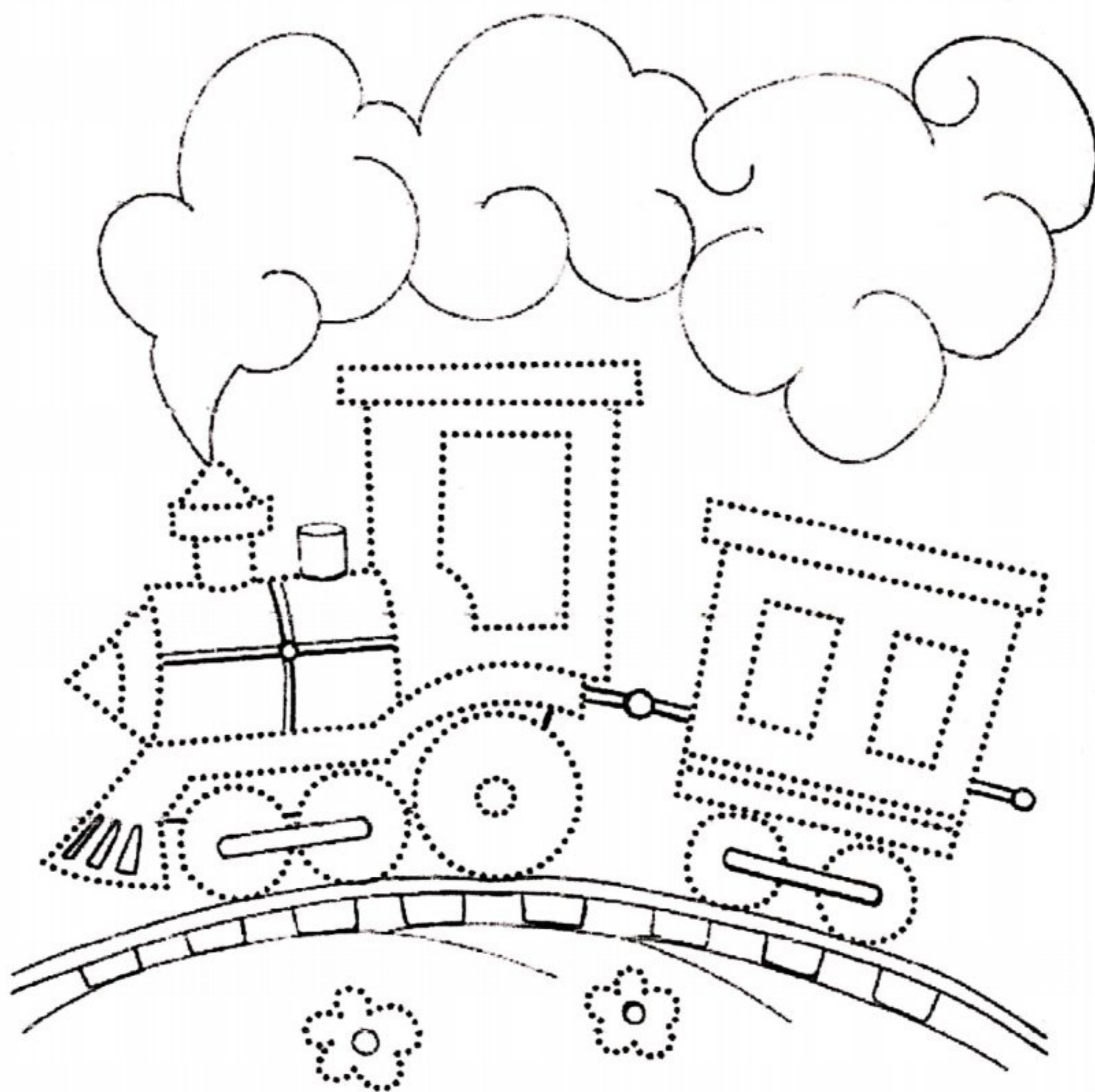

COMPLETE O PONTILHADO DO DESENHO



ALEGRIA
DE
APRENDER



A B C D E F

G H I J K L

M N O P

Q R S T U

V W X Y Z.



VAMOS CONTAR E PONTILHAR.

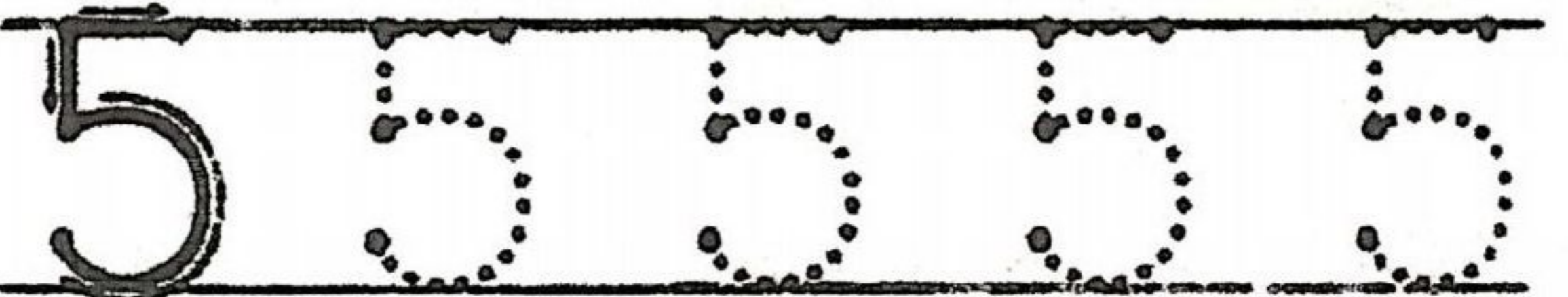
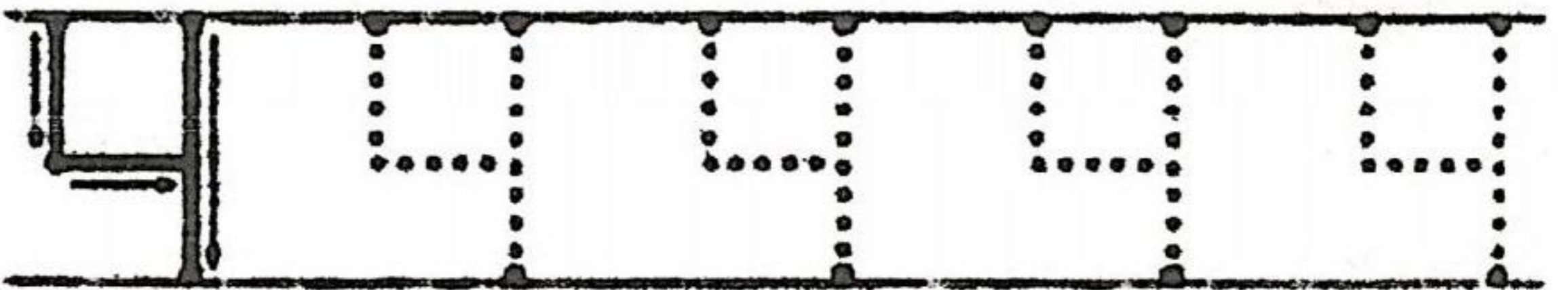
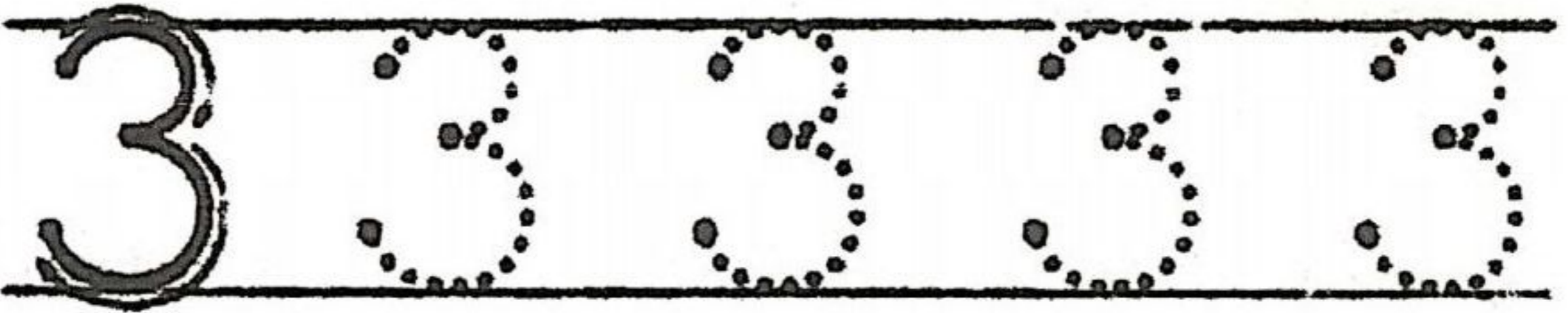
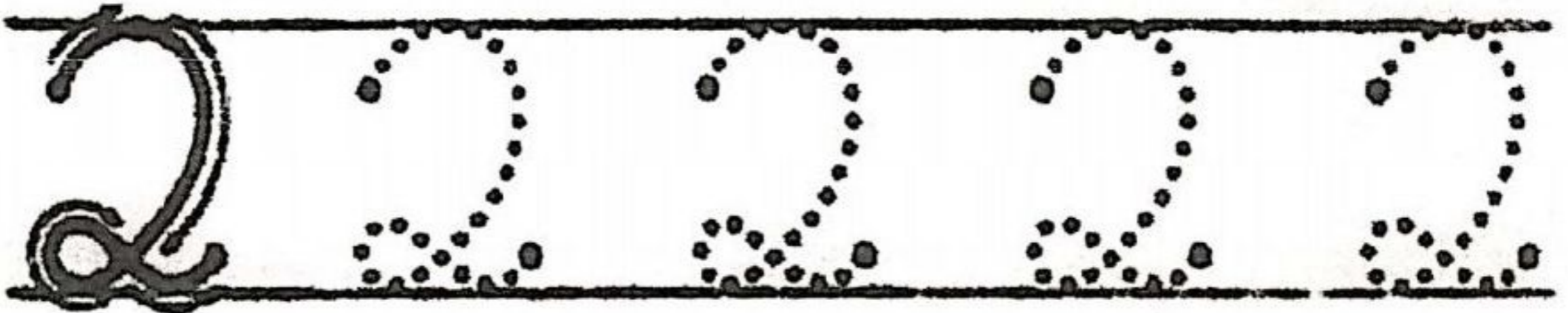
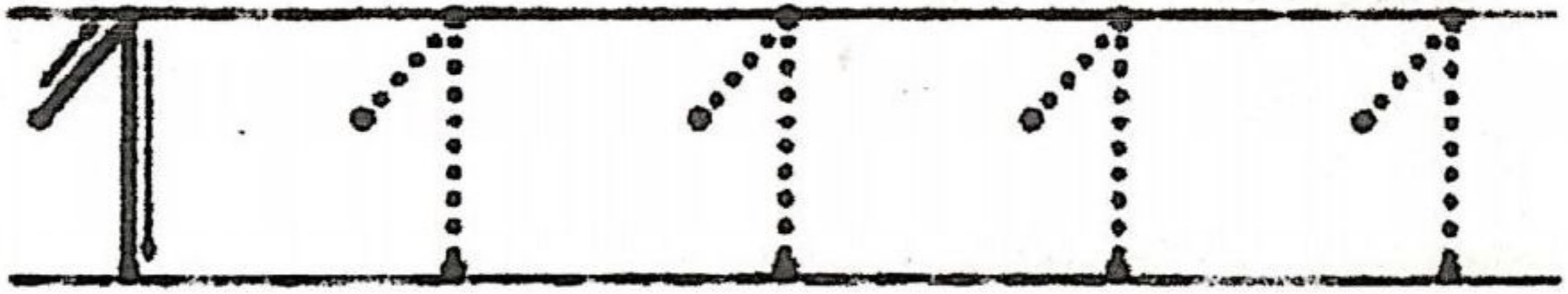

APRENDENDO OS NÚMEROS
PINTE O NÚMERO ABAIXO

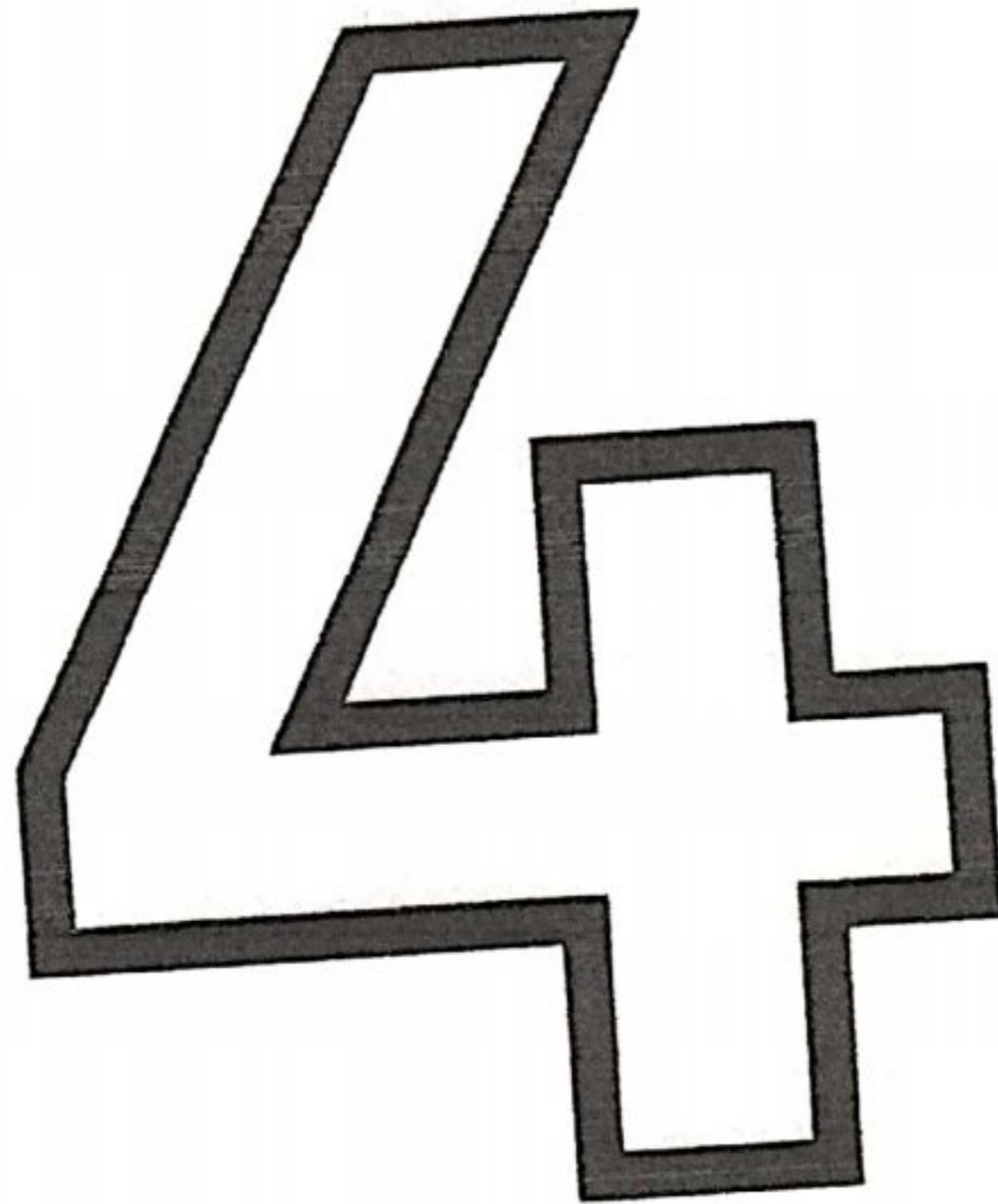

QUATRO

VAMOS TREINAR COM TRACEJADOS

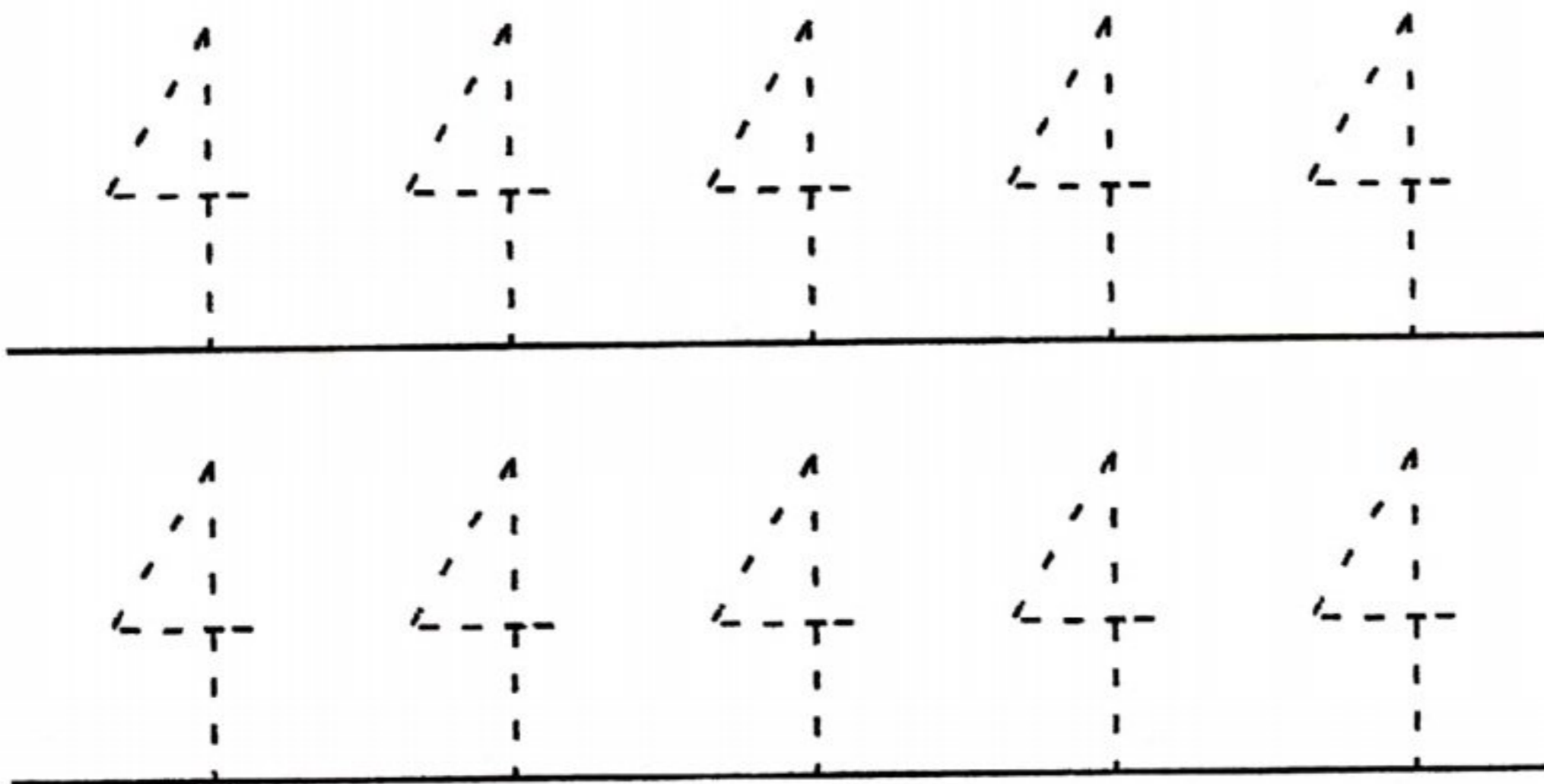
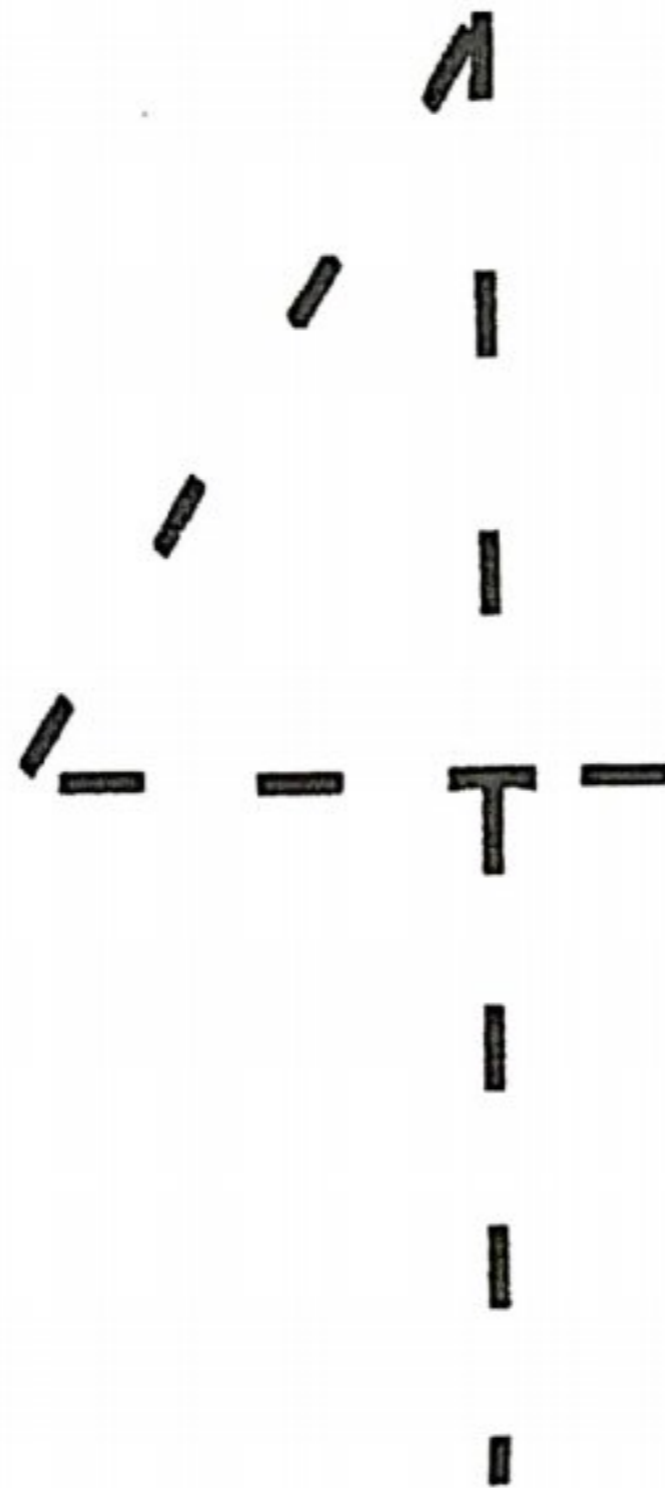

COLE FIGURAS NA QUANTIDADE DO
NÚMERO ABAIXO

4

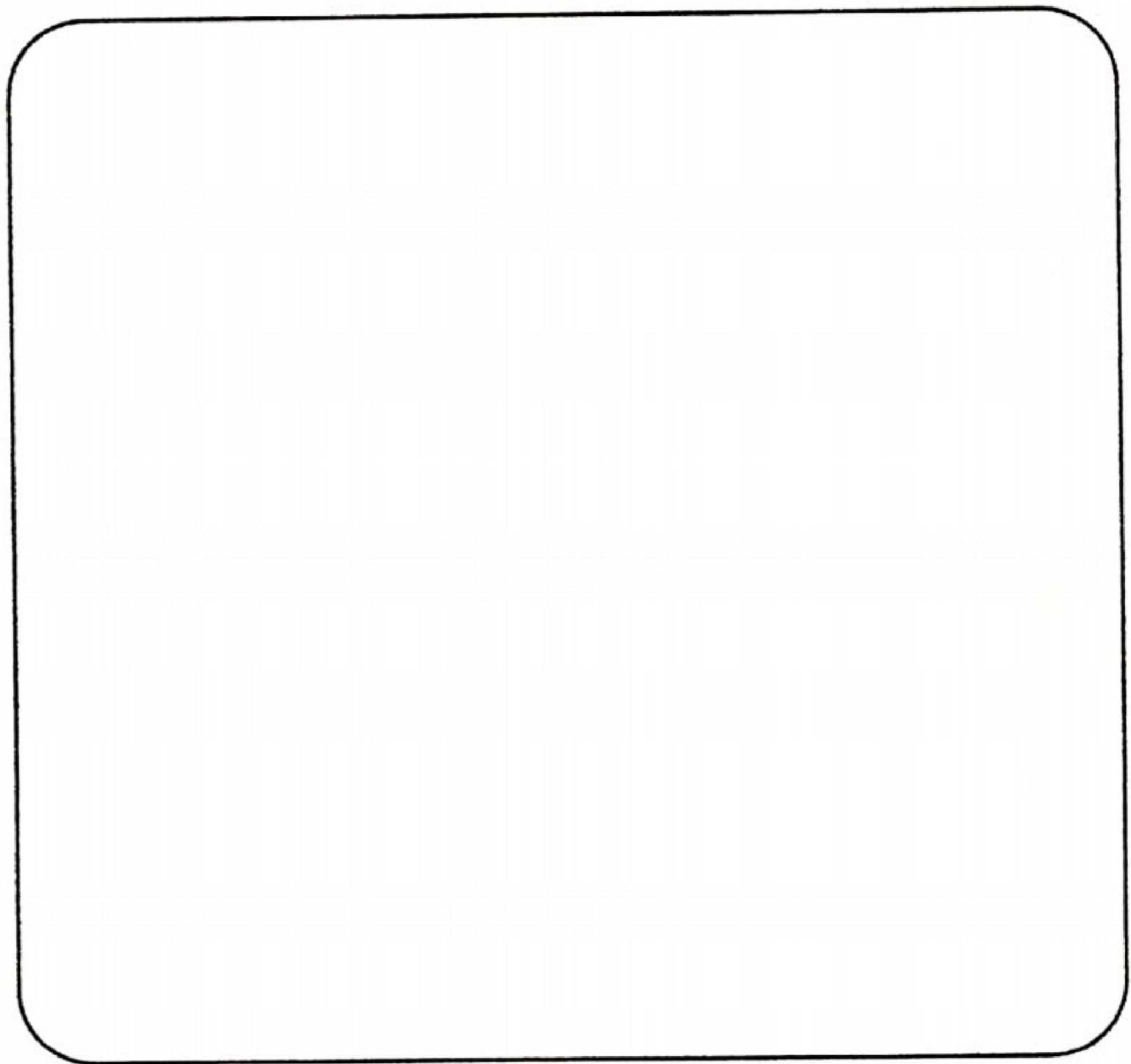

QUATRO

CIRCULE APENAS O NÚMERO 4

8

6

7

4

4

5

2

7

1

4

8

6

4

7

6

0

APRENDENDO O ALFABETO
PINTE A LETRA ABAIXO

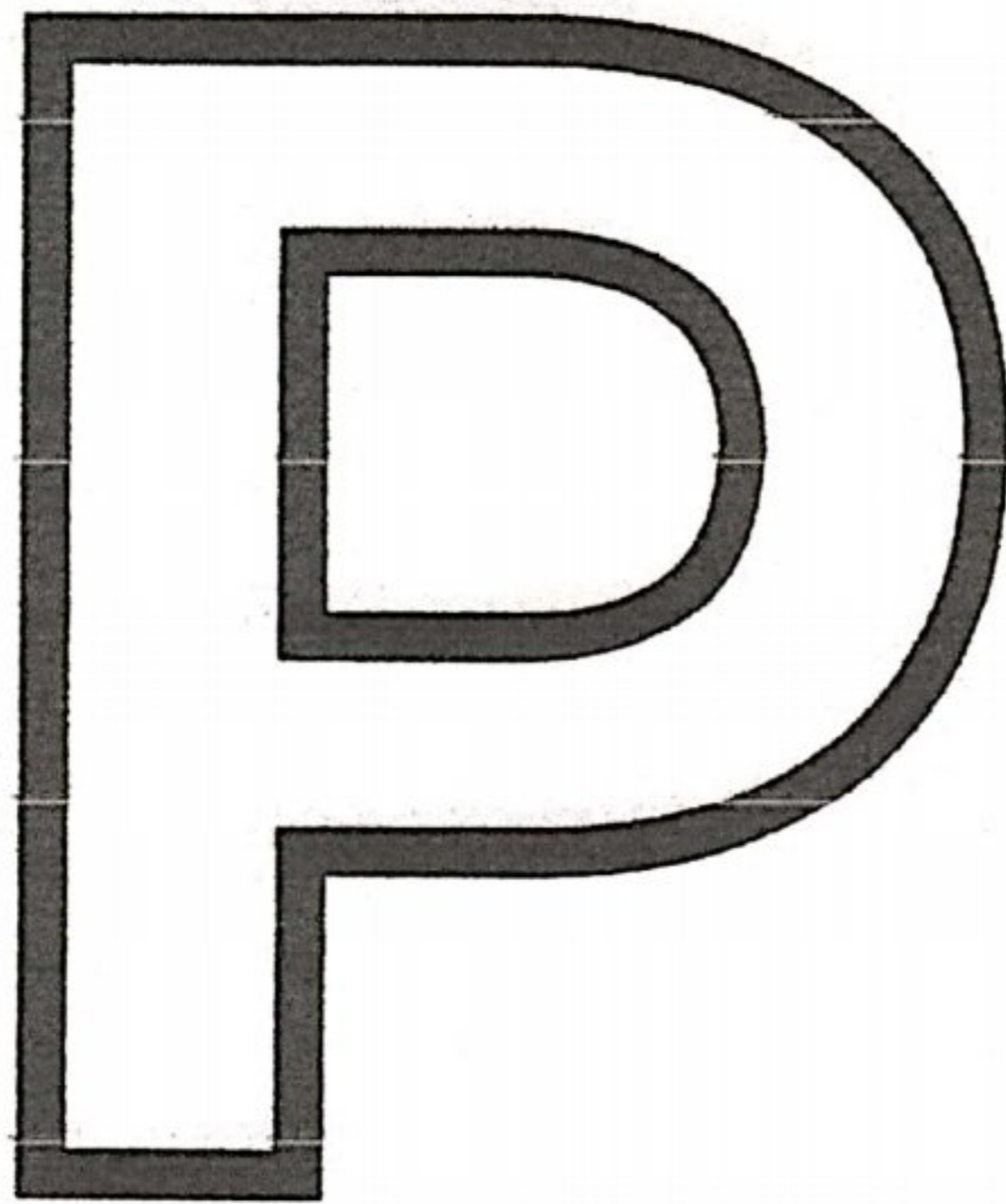

PAPAGAIO

VAMOS TREINAR COM PONTILHADO

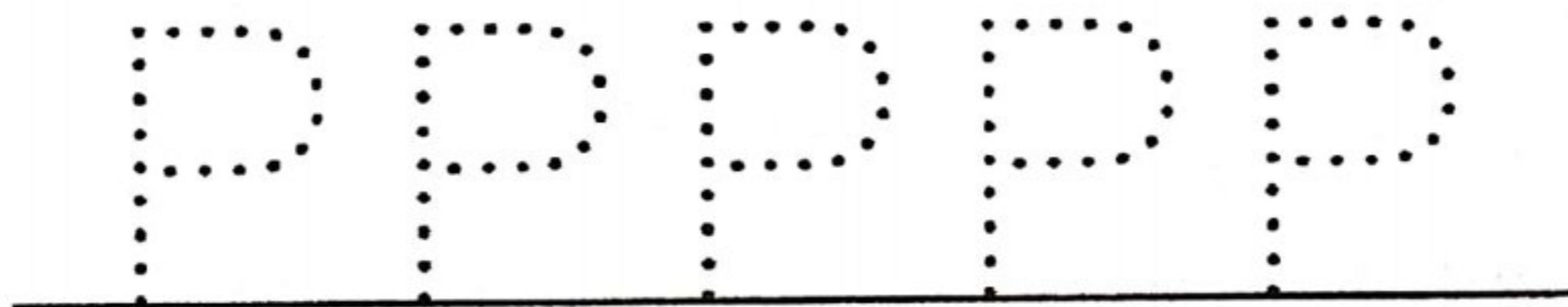
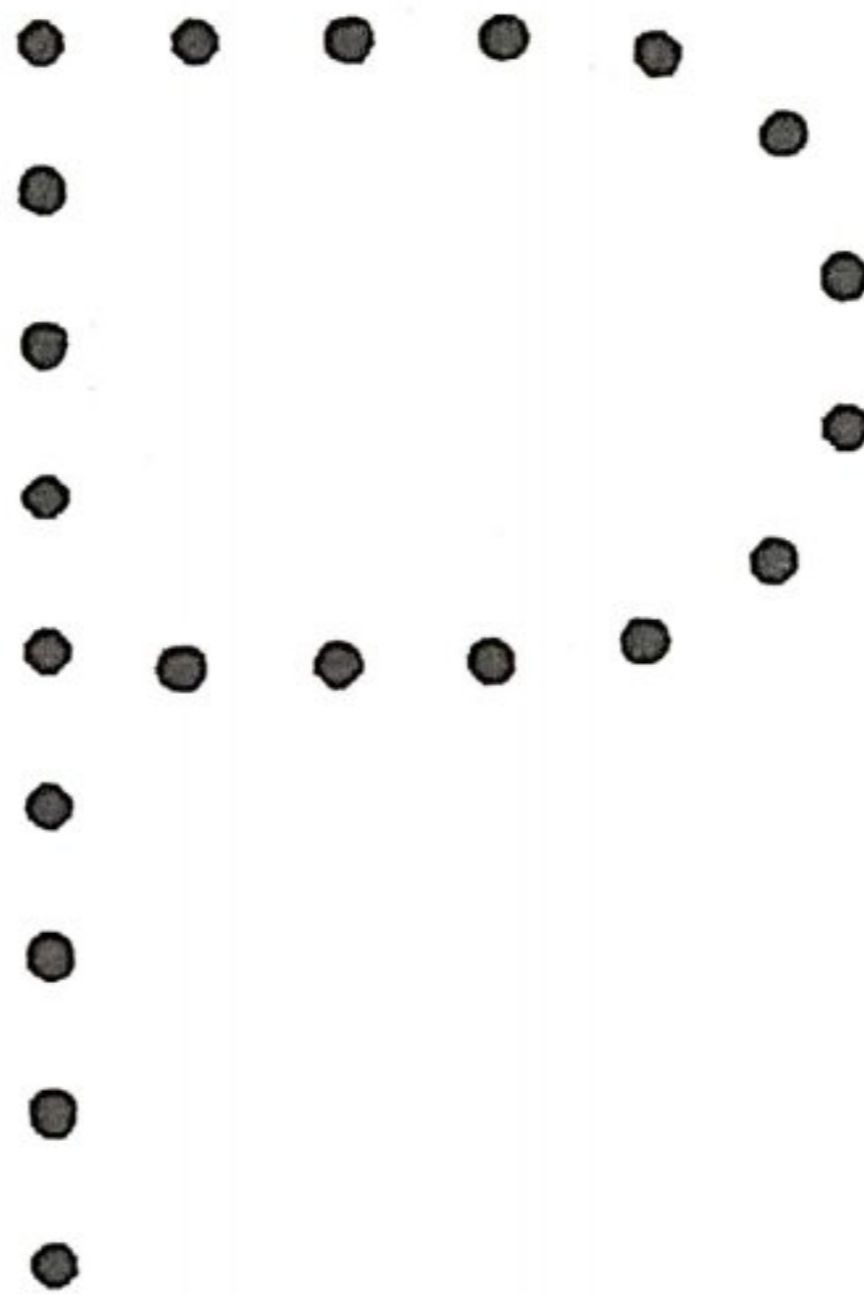

CIRCULE APENAS A LETRA P

A

N

P

F

J

P

M

K

Q

S

E

P

R

P

K

U

FELIZ DIA DOS PAIS



TE AMO PAI
O SENHOR É LEGAL
O QUE DAREI Á UM PAI
DE TAL MODO SENSACIONAL?

✦ PINTE O NOME PAI EM CADA COLUNA.

PAI
MÃE
MAGALI

MAGALI
PAI
MÃE

MÃE
MAGALI
PAI

VAMOS AJUDAR O CEBOLINHA A ENCONTAR O SEU PAI!



CEBOLINHA

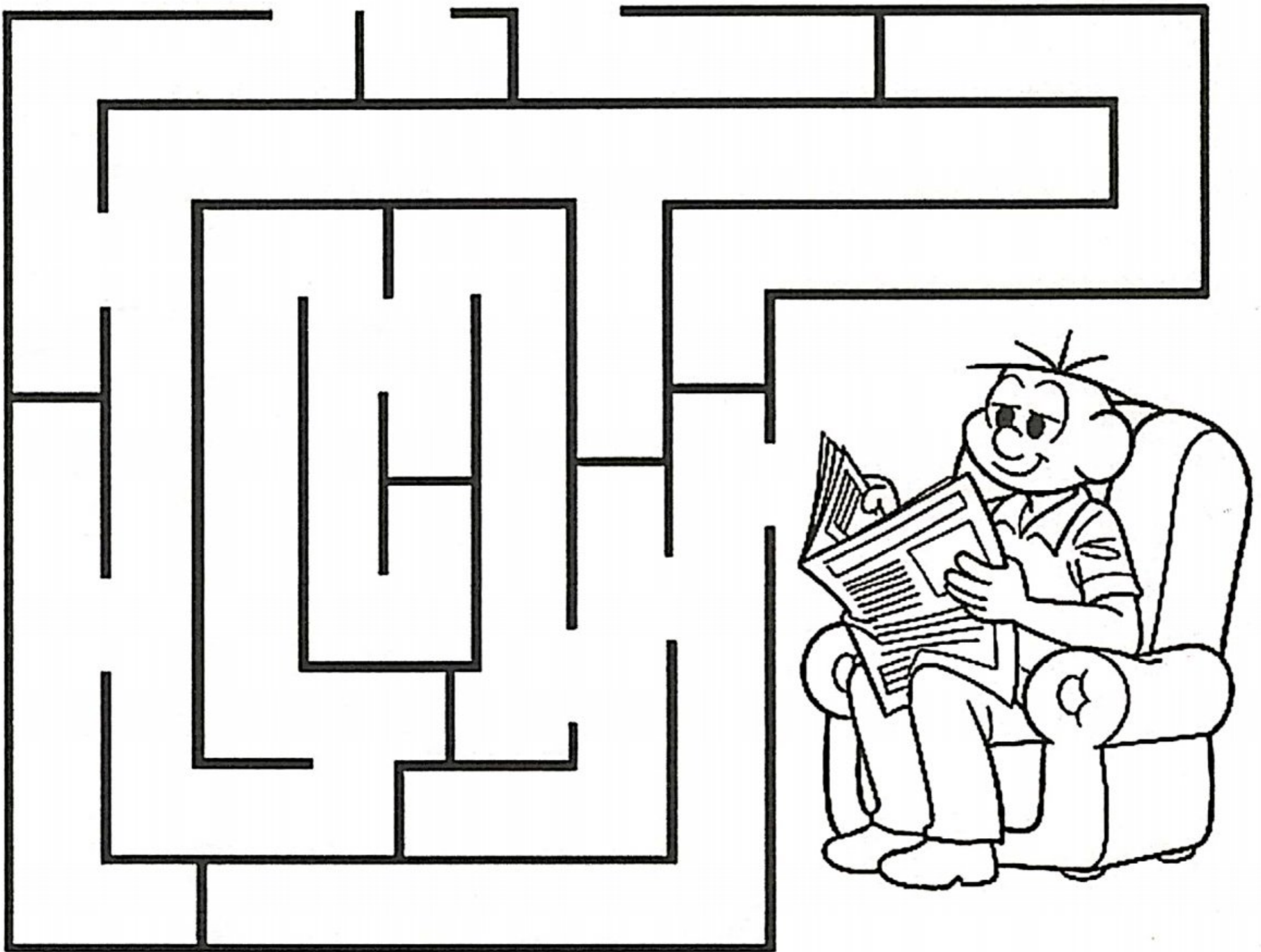

SEU CEBOLA

MEU PAI É ASSIM ...

DESENHE

MINHA MÃOZINHA APONTA 5 PALAVRINHAS QUE EU
QUERIA DIZER

QUERIDO PAPAI AMO MUITO VOCÊ.

EM DIAS DE LAZER MEU PAI GOSTA
DE ...

DESENHE

**DESENHE OS PRESENTES QUE VOCÊ
GOSTARIA DE DAR PARA O SEU PAPAI!**

AJUDE IARA A CHEGAR NO RIO COMPLETANDO O ALFABETO COM AS LETRAS QUE FALTAM.



A sequence of 21 circles arranged in four rows for a word search puzzle. The letters present are:

- Row 1: [] B [] [] []
- Row 2: L [] [] [] [] G []
- Row 3: [] [] [] [] Q [] []
- Row 4: Z [] [] [] V [] []

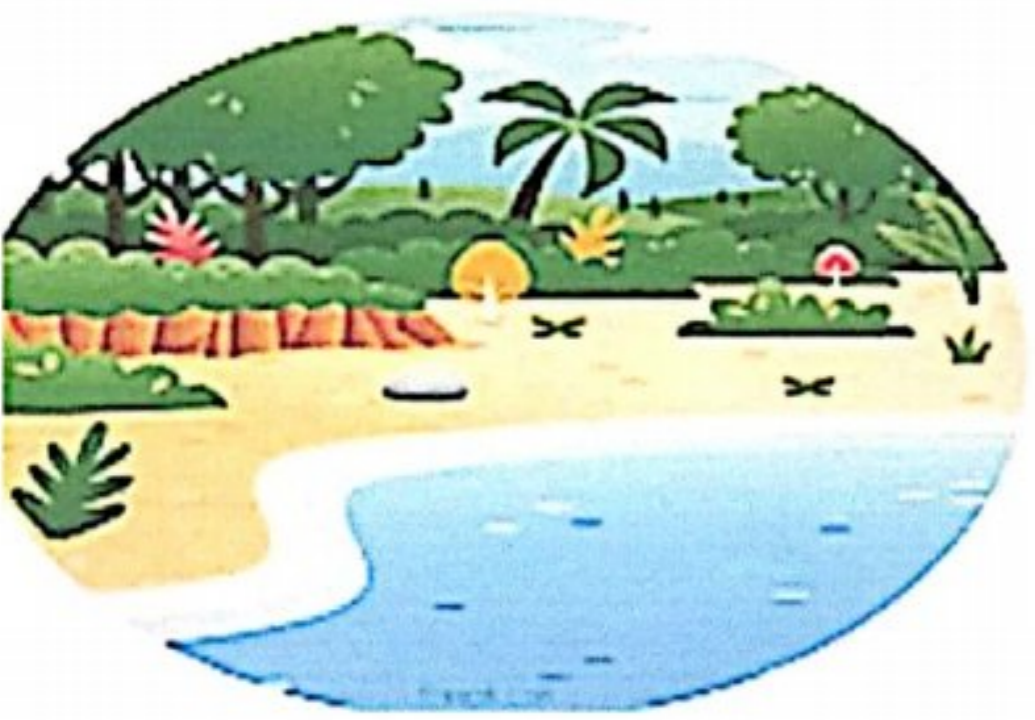

VAMOS COMPLETAR O NOME DOS PERSONAGENS DO FOLCLORE USANDO SOMENTE AS VOGAIS!



LOBISOMEM

L B S M M



CURUPIRA

C R P R



CUCA

C C



BOTO

B T



MULA

M L



SACI

S C



VEJA OS PERSONAGENS DO NOSSO FOLCLORE E ESCREVA SEUS NOMES.



S	A	C	I



M	U	L	A



I	A	R	A

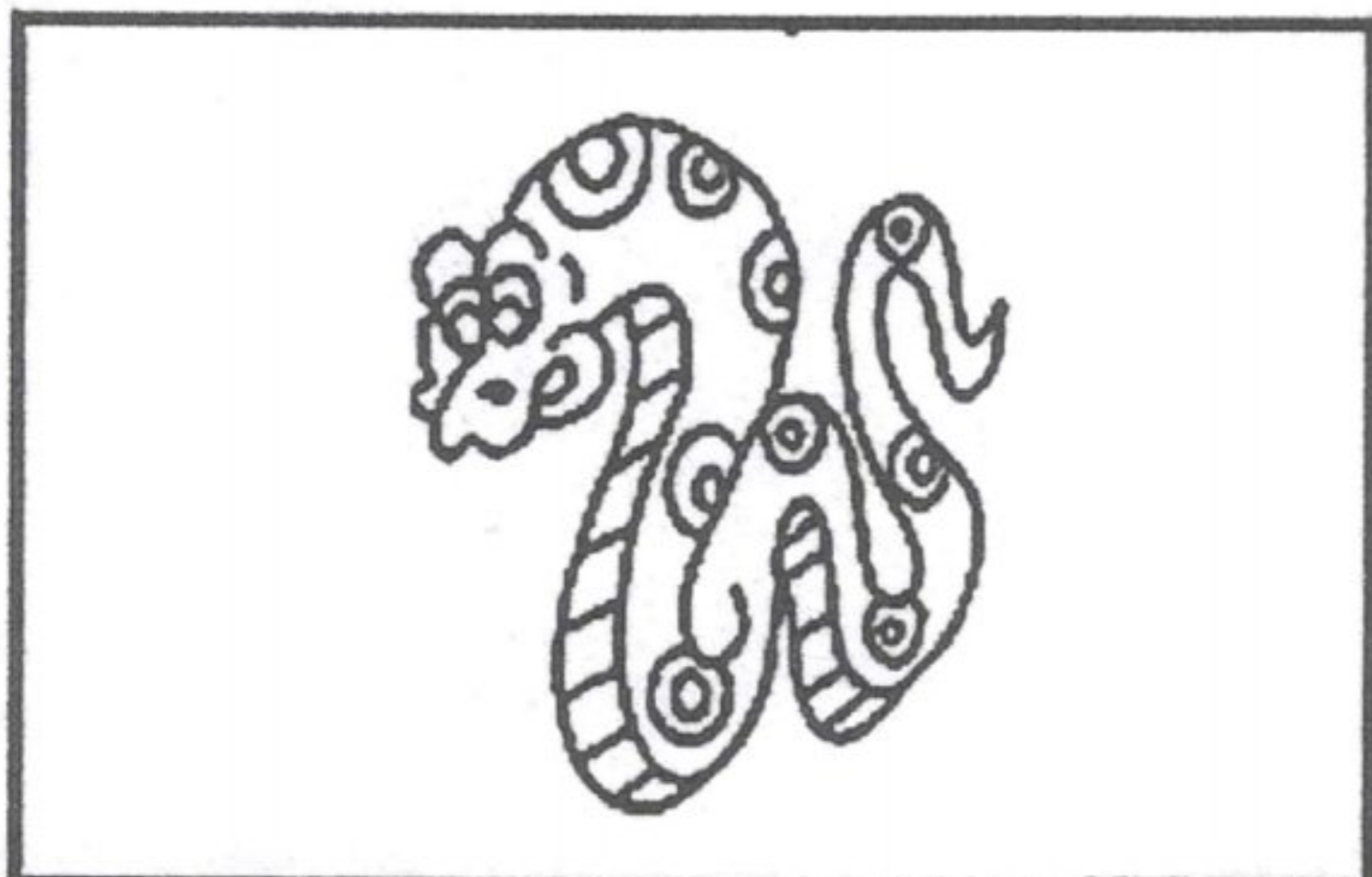

B	O	I	T	A	T	Á





C	U	R	U	P	I	R	A



VAMOS CONTAR QUANTOS
ELEMENTOS TEM EM CADA CONJUNTO
E PINTAR O QUADRINHO COM O
NÚMERO CORRESPONDENTE.

	<table border="1"><tr><td>4</td><td>5</td></tr><tr><td>3</td><td>6</td></tr></table>	4	5	3	6
4	5				
3	6				

	<table border="1"><tr><td>4</td><td>5</td></tr><tr><td>3</td><td>6</td></tr></table>	4	5	3	6
4	5				
3	6				

	<table border="1"><tr><td>4</td><td>5</td></tr><tr><td>3</td><td>6</td></tr></table>	4	5	3	6
4	5				
3	6				



C U C A

DOBRADURA DO SACI

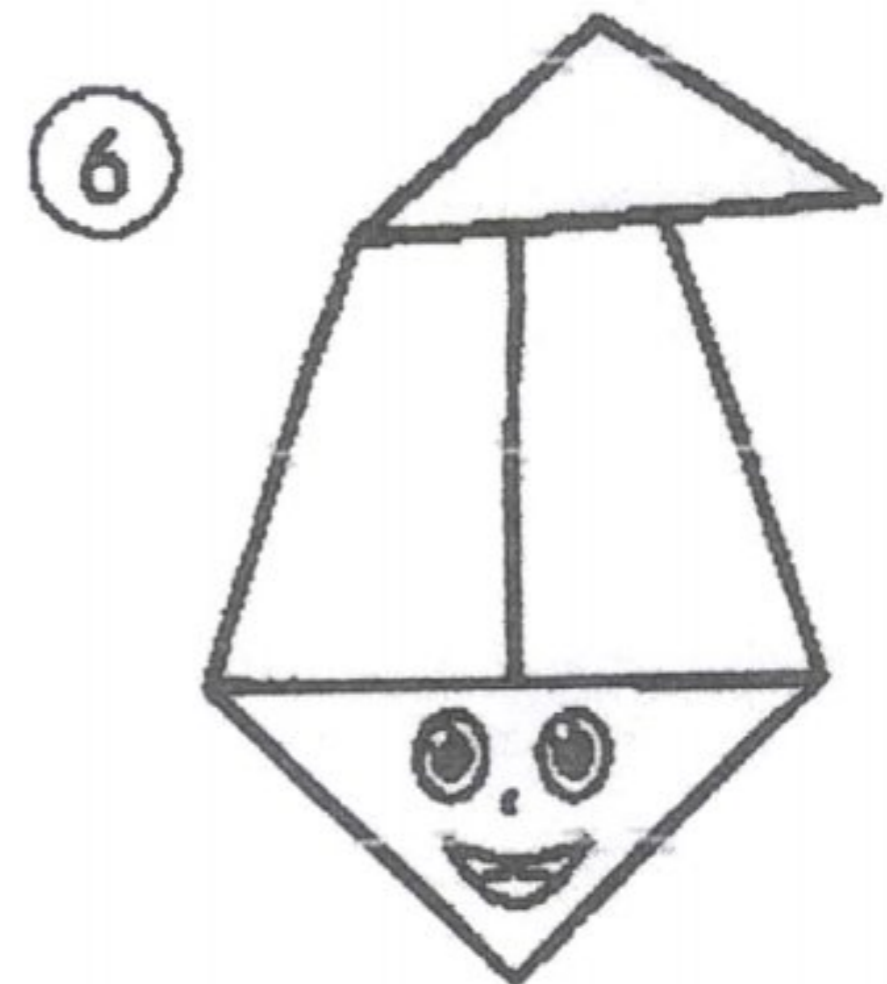
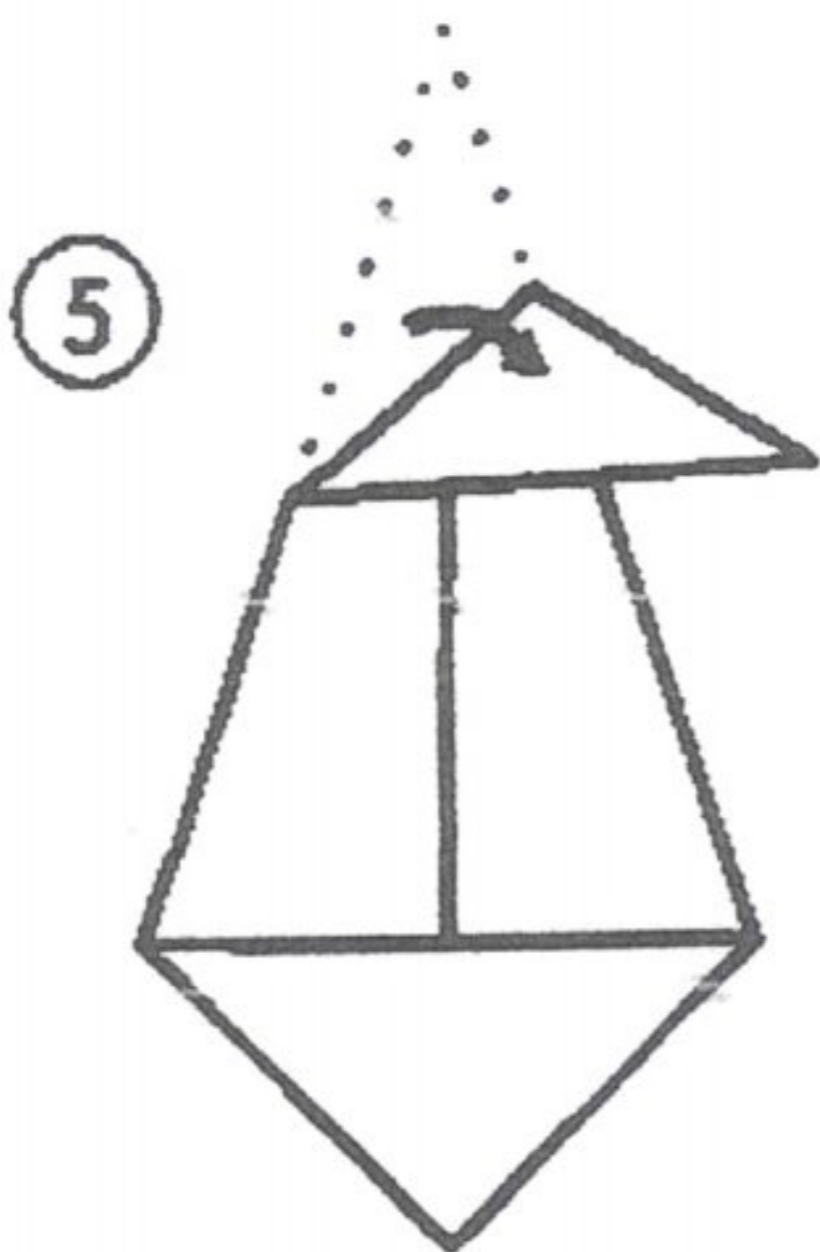
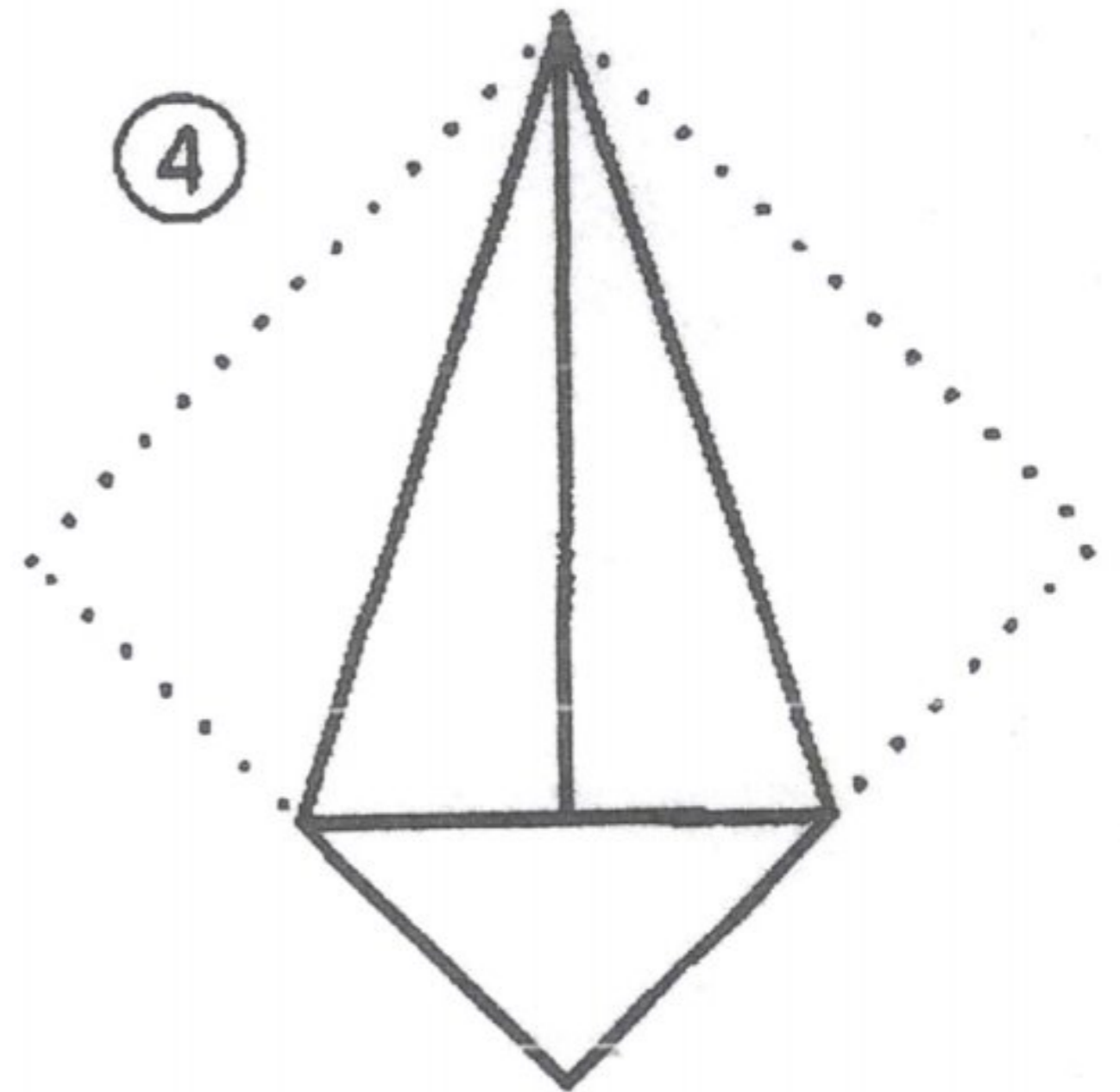
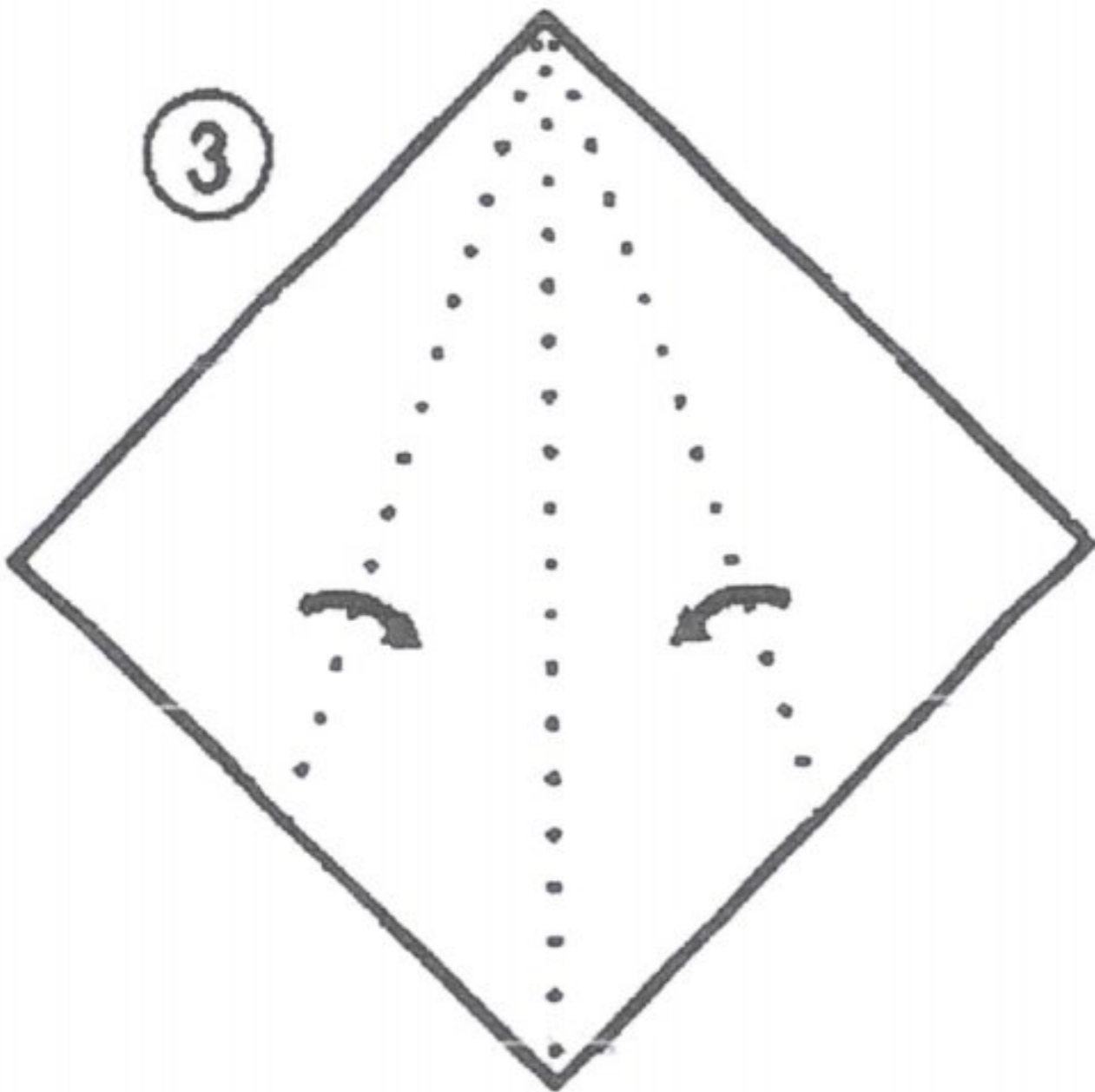
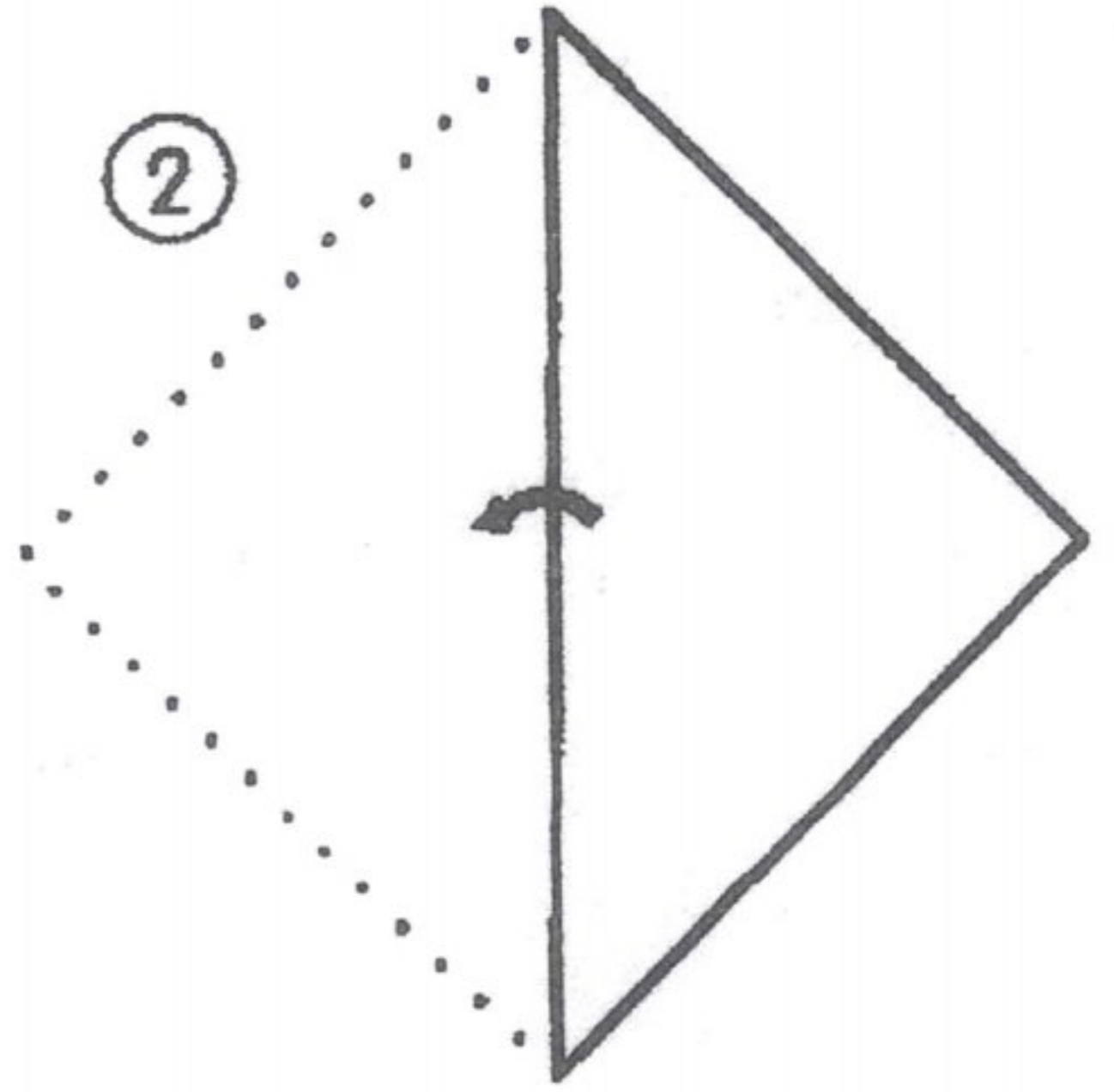
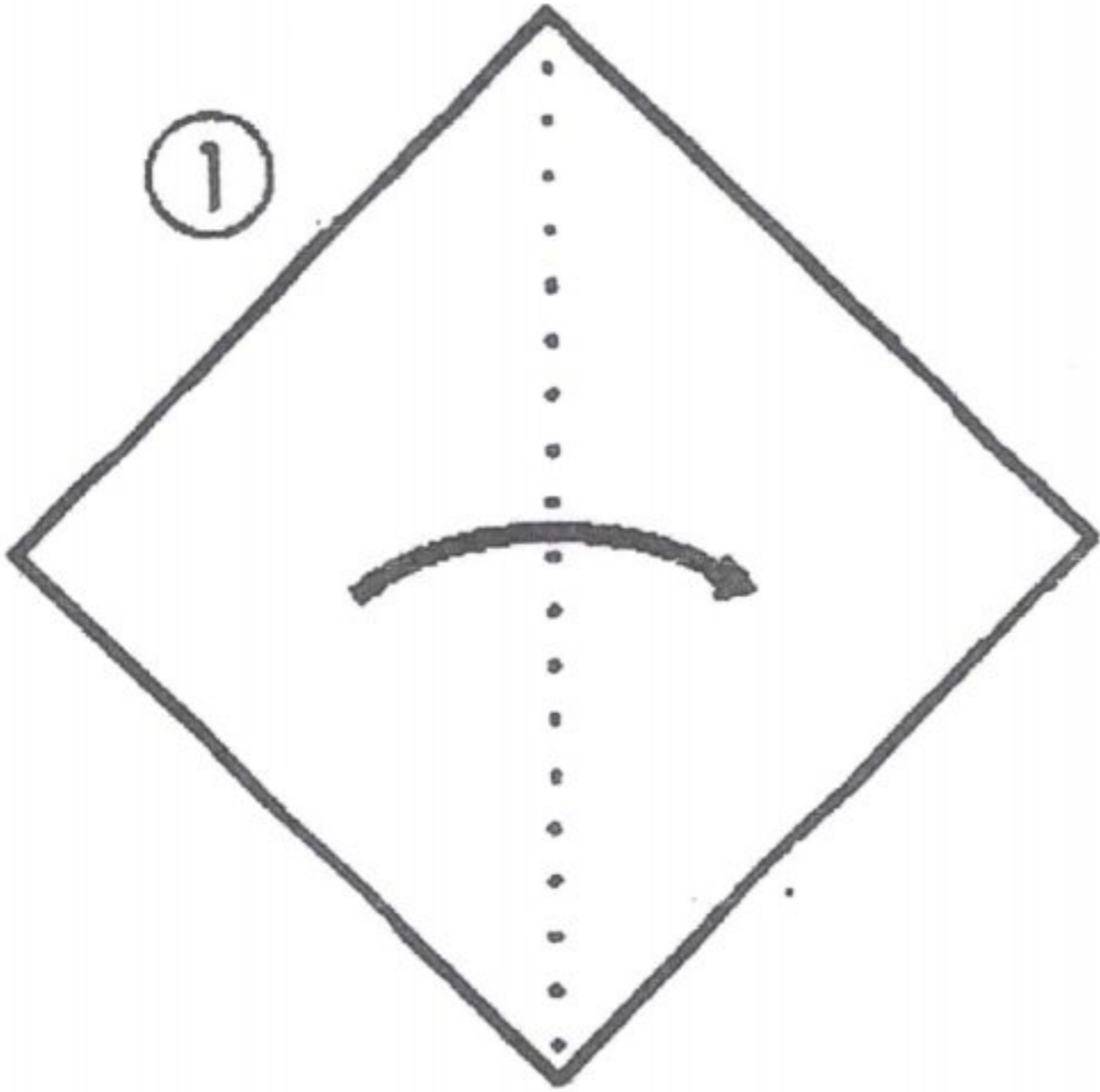

MÁSCARA DA CUCA



REFERÊNCIAS

Coleção A de Abelha;

Pinterest- atividadeseducacaoinfantil

Pinterest- Espaço Infantil

Jéssica Valentim- @abcdajessica

Pinterest- Pedagogia ao Pé da Letra

Pinterest- Aluno On

Pinterest- Só Escola

Pinterest- espacoeducar.net

Pinterest- 1bp.blogspot.com