

Escola: E.M. Maria Aparecida Gabriel Cardoso

Data: 30/08 á 17/09 Turma: 1º ANO B

Nome: \_\_\_\_\_

Professora: Alice Barbaresco dos Santos

**Devolver as atividades 20/09/2021**

**INDEPENDÊNCIA**

**SIM!**



## **7 DE SETEMBRO DIA DA INDEPENDÊNCIA**

NO DIA 7 DE SETEMBRO, COMEMORAMOS O "DIA DA INDEPENDÊNCIA";

O BRASIL FOI DESCOBERTO POR UM PORTUGUÊS, POR CAUSA DISSO, O BRASIL FICOU PERTECENDO A PORTUGAL.

O PRÍNCIPE D. PEDRO, PROCLAMOU A INDEPENDÊNCIA DO BRASIL DE PORTUGAL, NO DIA 7 DE SETEMBRO DE 1822.

D. PEDRO FICOU SENDO O PRIMEIRO IMPERADOR DO BRASIL, COM O TÍTULO DE DOM PEDRO I.

MUITAS PESSOAS INFLUIRAM PARA D. PEDRO PROCLAMAR A INDEPENDÊNCIA, ENTRE ELAS JOSÉ BONIFÁCIO DE ANDRADA E SILVA E A PRINCESA LEOPOLDINA.

POR ESTE MOTIVO, JOSÉ BONIFÁCIO RECEBEU O TÍTULO DE "PATRIARCA DA INDEPENDÊNCIA".

PORTANTO, EM SETEMBRO, NÓS, DURANTE UMA SEMANA, FESTEJAMOS OS HERÓIS DA INDEPENDÊNCIA.



**COMPLETE A CRUZADINHA E DESCUBRA O QUE COMEMORAMOS NO DIA 7 DE SETEMBRO:**

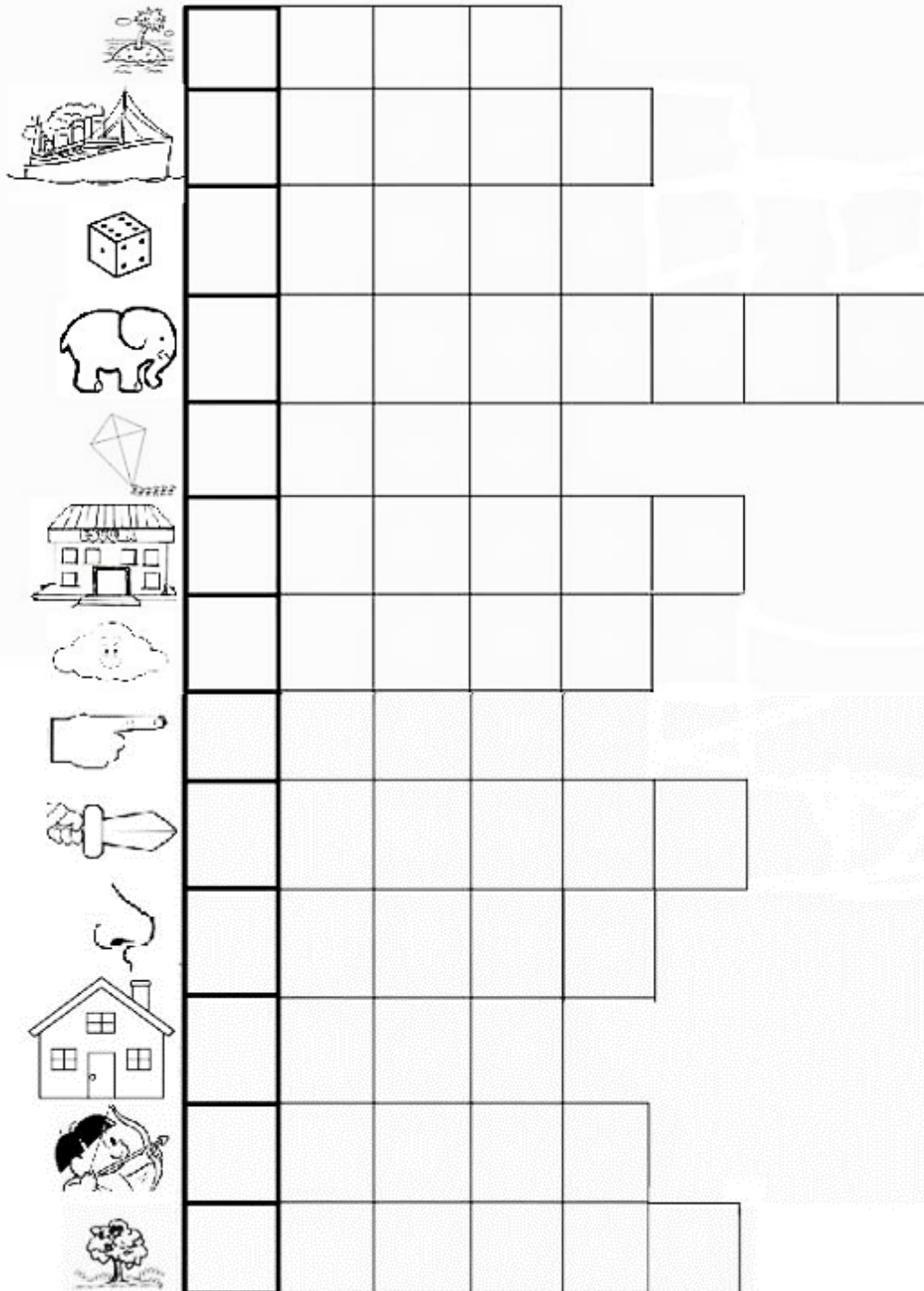

**NO DIA 7 DE SETEMBRO, COMEMORAMOS O DIA DA \_\_\_\_\_**

BANCO DE PALAVRAS

**NUVEM - DEDO - PIPA – ESCOLA – NAVIO – ILHA – DADO  
ELEFANTE - CASA – ESPADA – NARIZ – ÁRVORE - ÍNDIO**

HISTÓRIA - DATA: \_\_\_\_/\_\_\_\_/\_\_\_\_

# 7 DE SETEMBRO - INDEPENDÊNCIA DO BRASIL

A partir de quando o Brasil ficou pertencendo à Portugal?



Desde que foi descoberto por Pedro Álvares Cabral, em 1500. O Brasil era colônia de Portugal.



Portugal queria que o Brasil voltasse a ser apenas uma colônia, mas D. Pedro não aceitava mais essa situação.



Então, foi no dia 7 de setembro de 1822, às margens do rio Ipiranga, em São Paulo, que D. Pedro I proclamou a Independência do Brasil, com o grito: Independência ou morte.



A partir desse dia, o Brasil não pertencia mais a Portugal. O Brasil era um país livre.



Nossa! Que interessante essa história. Quero saber mais um pouquinho. Vou à biblioteca pesquisar. Obrigado e até logo!

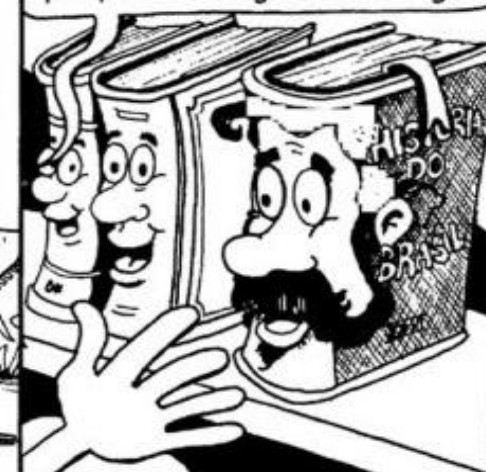

...Em 1808, o rei de Portugal D. João VI, e toda a família real mudaram-se para o Brasil, para evitar um conflito com Napoleão Bonaparte.



...Mas, em 1821, o rei voltou para Portugal e deixou o seu filho D. Pedro I como príncipe regente do Brasil.





## 7 DE SETEMBRO INDEPENDÊNCIA DO BRASIL!

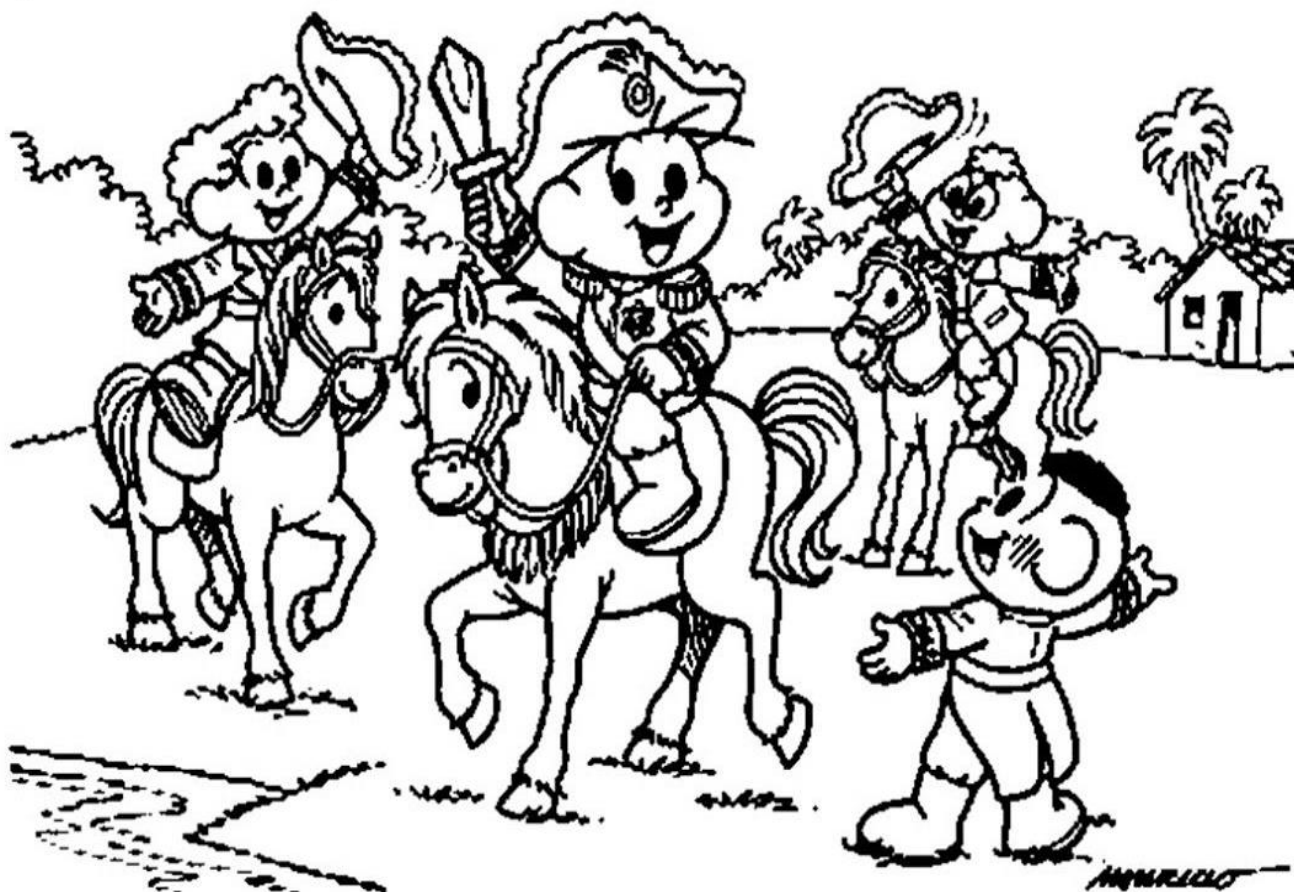

**OBSERVE O DESENHO ACIMA E RESPONDA:**

**1- QUANTOS CAVALOS HÁ NO DESENHO? \_\_\_\_\_**

**2- QUANTAS CRIANÇAS ESTÃO EM CIMA DOS CAVALOS? \_\_\_\_\_**

**3- QUANTAS CRIANÇAS ESTÃO FORA DOS CAVALOS? \_\_\_\_\_**

**4- QUANTAS CRIANÇAS HÁ AO TODO NO DESENHO? \_\_\_\_\_**

# 7 DE SETEMBRO

SETE DE SETEMBRO,  
 DATA TÃO FESTIVA,  
 FOI A INDEPENDÊNCIA  
 DESTA TERRA TÃO QUERIDA.



QUAL É O NOME DO NOSSO PAÍS?

--	--	--	--	--	--

COMPLETAR:

B	R	A	S	I	L

RESPONDER:

QUAL É A PRIMEIRA LETRA?	
QUAL É A ÚLTIMA LETRA?	
QUANTAS LETRAS TÊM?	

VAMOS RESOLVER?

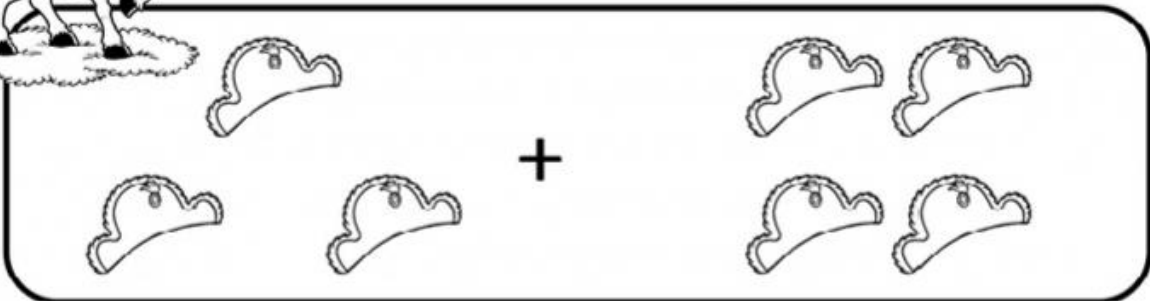

$$\square + \square = \square$$

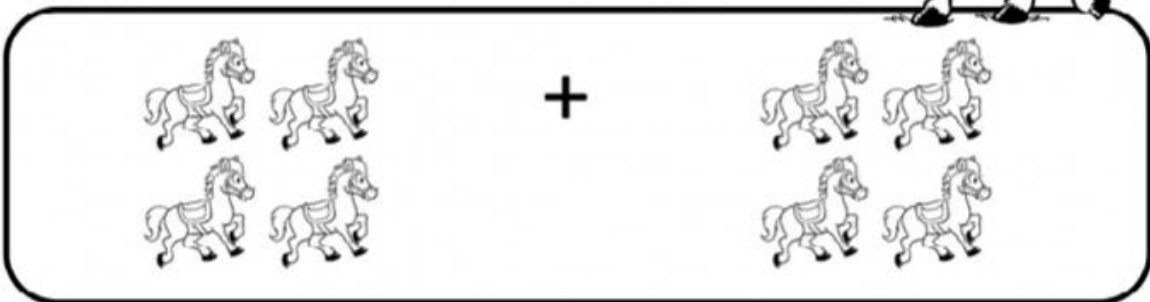

$$\square + \square = \square$$

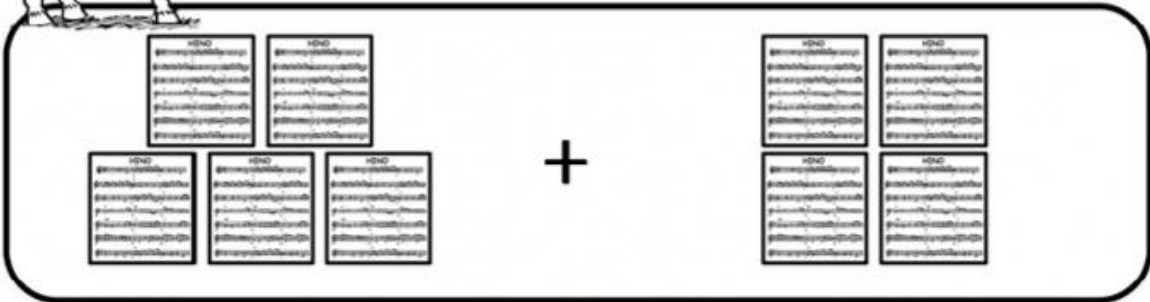

$$\square + \square = \square$$

**VAMOS COLORIR A BANDEIRA DO BRASIL. CAPRICHE!**

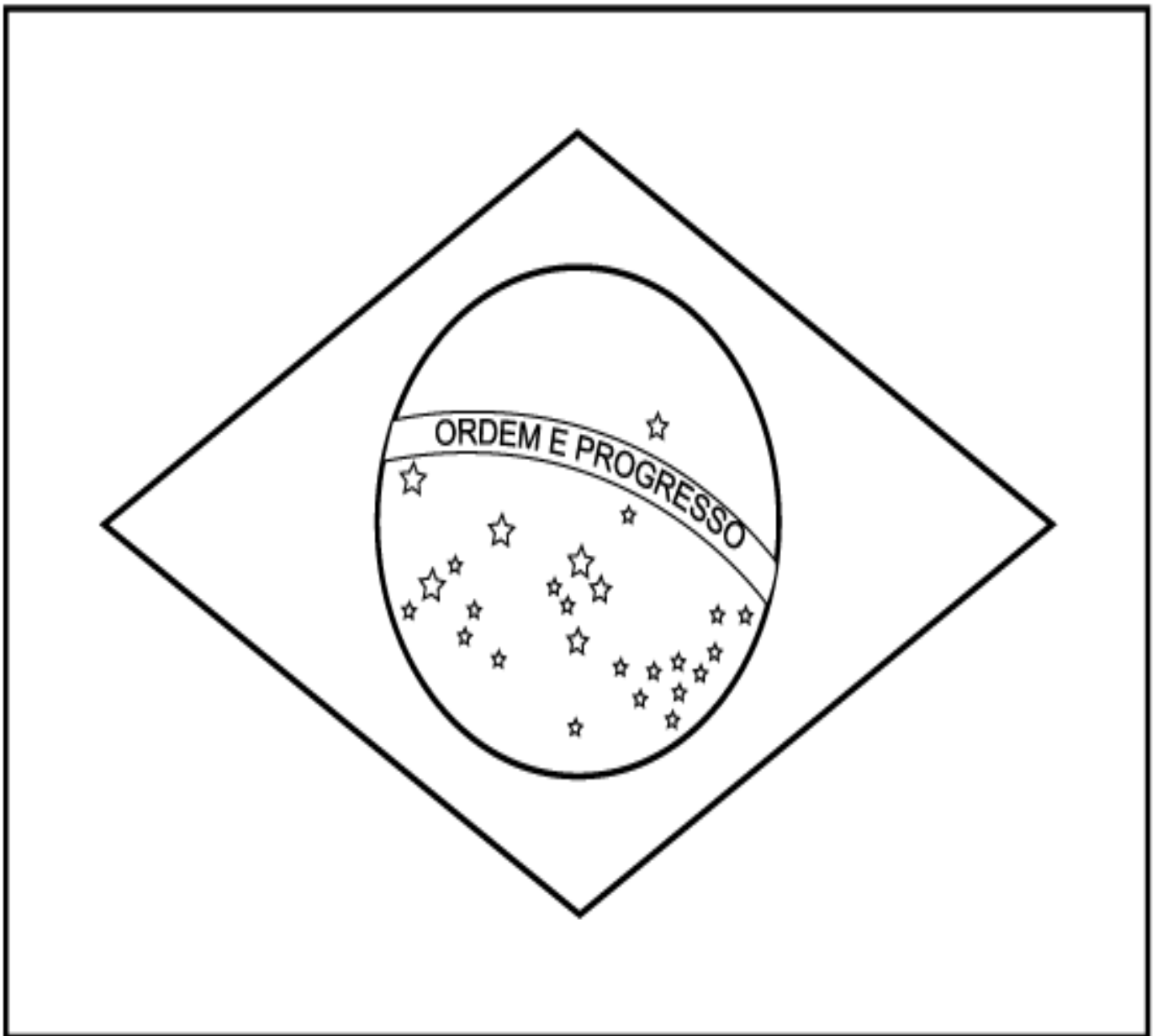



# 7 DE SETEMBRO - INDEPENDÊNCIA DO BRASIL

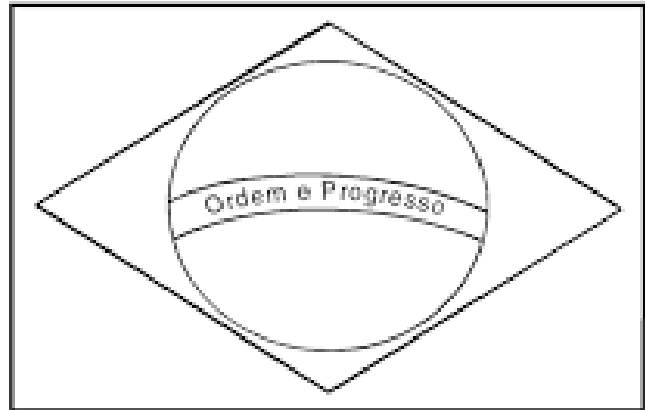

ESSA É A BANDEIRA DO

AS CORES DA BANDEIRA SÃO:

QUANTAS CORES SÃO?

O QUE ESTÁ ESCRITO NA BANDEIRA?

# 1. LIGUE OS SIGNIFICADOS DE CADA COR DA BANDEIRA NACIONAL



OURO E RIQUEZAS



CÉU



PAZ



MATAS E FLORESTAS



# CALENDÁRIO SETEMBRO DE 2021



Dom	Seg	Ter	Quar	Qui	Sex	Sab
*	*	*	1			
		7				
				31	*	*

- 1) COMPLETE O CALENDÁRIO DO MÊS DE SETEMBRO.
- 2) QUANTOS DIAS TEM O MÊS DE SETEMBRO? \_\_\_\_\_
- 3) PINTE DE VERMELHO TODOS OS DOMINGOS DESSE MÊS.
- 4) O DIA 7 DE SETEMBRO CAI EM QUAL DIA DA SEMANA? \_\_\_\_\_

## MÚSICA DA FAMÍLIA DO J

ISABEL CRISTINA SILVEIRA SOARES

O **J** JÁ CANSADO

DE FICAR ASSIM TÃO SÓ,

JUNTOU-SE COM O **O**E FELIZ FORMOU O **JO**.

ENCONTRANDO AS VOGAIS

FOI COM ELAS SE JUNTANDO:

COM O **A** FORMOU O **JA**COM O **I** FORMOU O **JI**,

AGORA MAIS CONTENTE

NÃO ESTAVA TÃO SOZINHO

COM O **E** FORMOU O **JE**E COM **U** FORMOU O **JU**.**JÁ, JE, JI, JO, JU!**

	PE
--	----

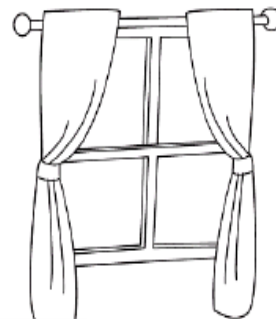

	NELA
--	------



	LIANO
--	-------

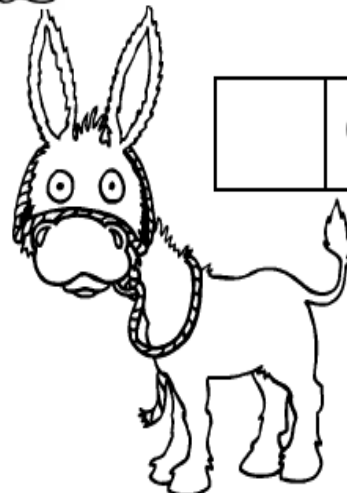

	GUE
--	-----

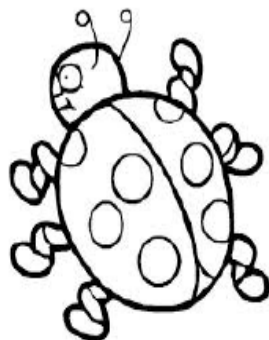

	ANINHA
--	--------

PINTE AS JOANINHAS DE ACORDO COM O NÚMERO DE BOLINHAS  
ESTIPULADO NA LEGENDA ABAIXO:

5 BOLINHAS - AZUL

6 BOLINHAS ■ VERMELHO

7 BOLINHAS ■ AMARELO

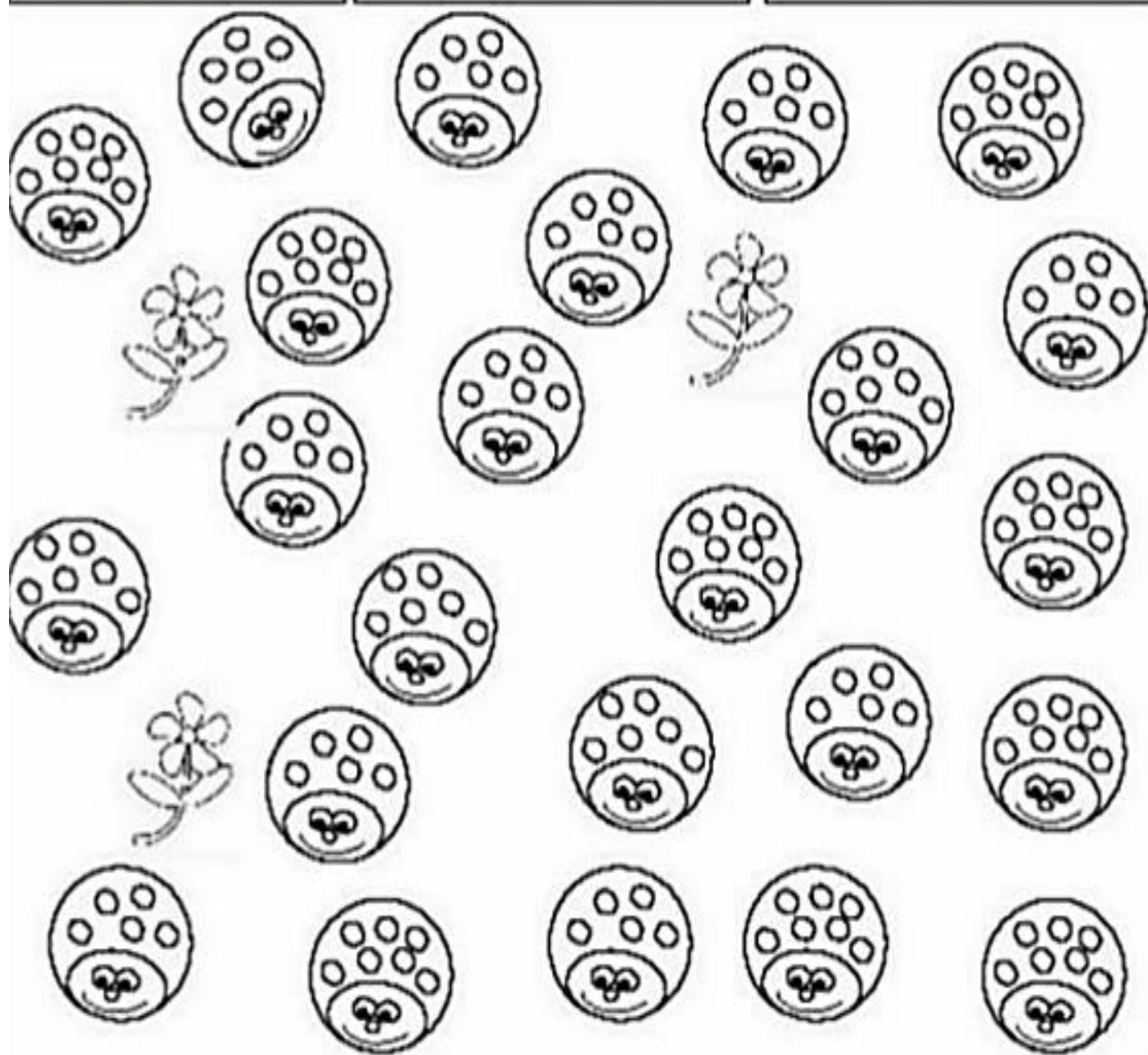

- QUANTAS JOANINHAS DE CADA TIPO?

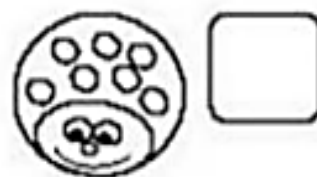

- QUANTAS JOANINHAS AO TODO?

NOME: \_\_\_\_\_

09/09/2021

LINGUAGEM  
FAMÍLIA SILÁBICA **J**



LINGUAGEM  
FAMÍLIA SILÁBICA **J**

UNA A LETRA **J** COM CADA VOGAL E FORME AS SÍLABAS:

COMPLETE COM: **JA** **JE** **JI** **JO** **JU**

**J**

**A** **E** **I** **O** **U**



\_\_\_\_\_

\_\_\_\_\_

\_\_\_\_\_

\_\_\_\_\_

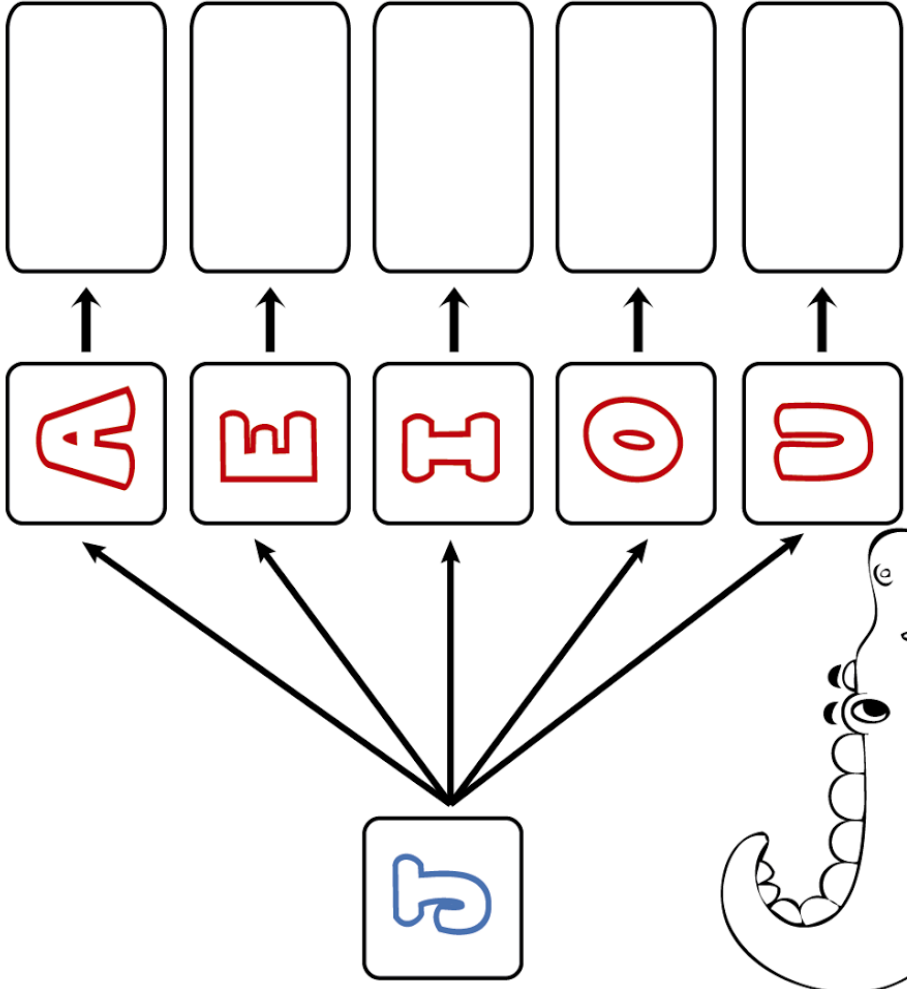
\_\_\_\_\_

\_\_\_\_\_ CARÉ \_\_\_\_\_



\_\_\_\_\_ NELA \_\_\_\_\_

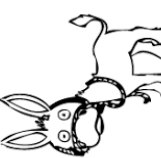

\_\_\_\_\_ GUE \_\_\_\_\_

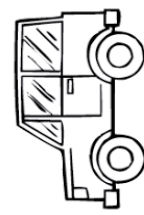

\_\_\_\_\_ PE \_\_\_\_\_



\_\_\_\_\_ BOIA \_\_\_\_\_



\_\_\_\_\_ RNAL \_\_\_\_\_



\_\_\_\_\_ IA \_\_\_\_\_



\_\_\_\_\_ JUBA \_\_\_\_\_

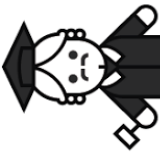

\_\_\_\_\_ IZ \_\_\_\_\_

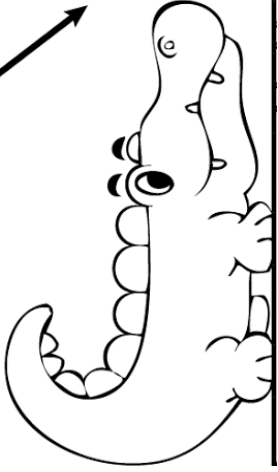

# João e o Pé de Feijão

COMPLETE A ORDEM NUMÉRICA FAZENDO O CAMINHO DE JOÃO.



1		3							
				5		7			
							9		



		2							
				4		6			
							8		10



1									
				5					
									10



VOCÊ CONHECE A HISTÓRIA “JOÃO E O PÉ DE FEIJÃO”?

COM A AJUDA DE UM FAMILIAR FAÇA A LEITURA DO LIVRINHO QUE VOCÊ RECEBEU.

# João e o Pé de Feijão

RECORTE, ORGANIZE E COLE O TÍTULO DA HISTÓRIA



**PÉ | O | E | DE | JOÃO | FEIJÃO**



# João e o Pé de Feijão

CONTE OS FEIJÕES MÁGICOS DE CADA QUADRO.  
COLE O NUMERAL CORRESPONDENTE.

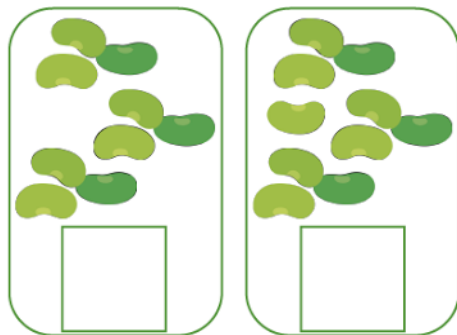
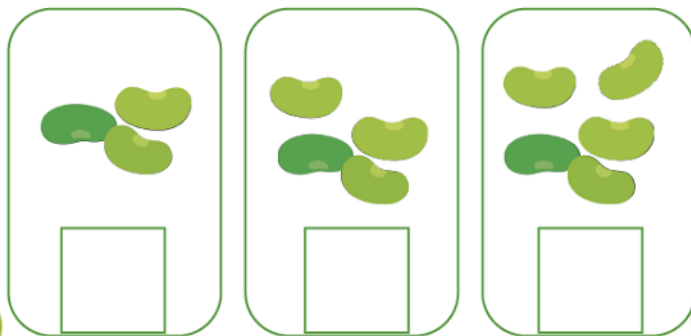
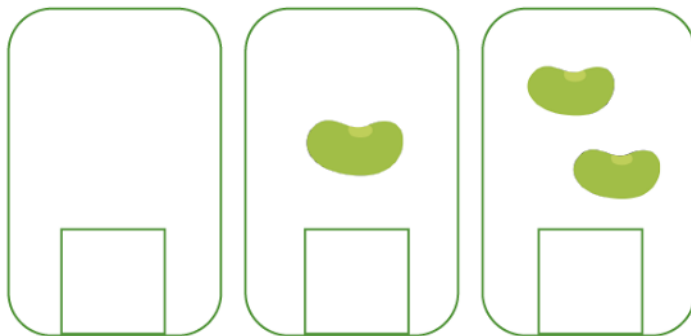

- |    |
|----|
| 1  |
| 2  |
| 3  |
| 4  |
| 5  |
| 6  |
| 7  |
| 8  |
| 9  |
| 10 |
| 0  |

# João e o Pé de Feijão

ENCONTRE O NOME DA CADA PERSONAGEM E PINTE.



JACK
JOSÉ
JOÃO



MÃE
NÃO
MÃO



GIGANTE
GOLIAS
GORDO



JOÃO
BEIJO
FEIJÕES



CASTELO
CASA
CARRO



MÁGICO
MOEDAS
MALETA



GALINHA
GELATINA
GANSA



HORAS
HARPA
HERA

# João e o Pé de Feijão

PINTE OS PÉS DE FEIJÕES

PEQUENOS DE AMARELO;  
MÉDIOS DE MARROM;  
GRANDES DE VERDE.

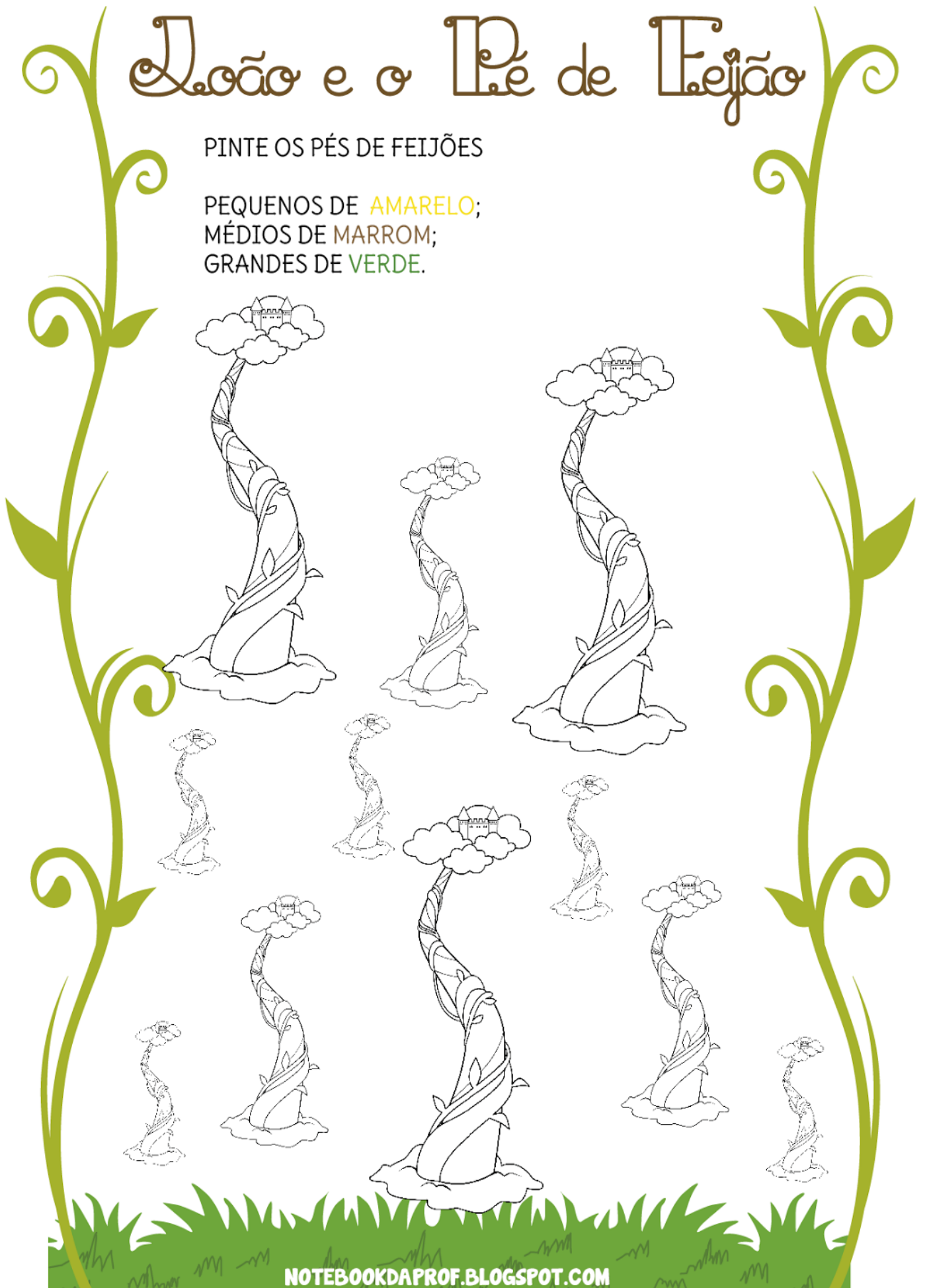

# João e o Pé de Feijão

RECORTE E COLE O PERSONAGEM NO QUADRO ONDE ESTÁ SEU NOME

JOÃO

VACA

FEIJÃO

MÃE

CASTELO

GIGANTE

MOEDAS

GALINHA

HARPA

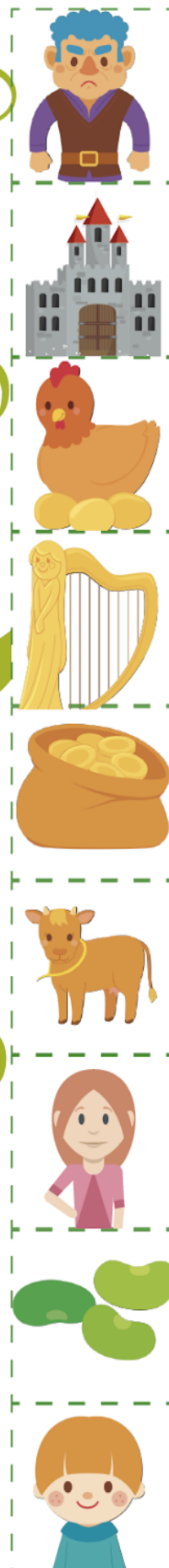

# João e o Pé de Feijão

PINTE OS FEIJÕES DE ACORDO COM A SEQUÊNCIA.

PADRÃO



PADRÃO



PADRÃO



PADRÃO



PADRÃO



# João e o Pé de Feijão

- PINTE UMA BOLINHA PARA CADA VEZ QUE ABRIR A BOCA PARA FALAR A PALAVRA.
- ANOTE QUANTAS BOLINHAS VOCÊ PINTOU.



Four empty circles for counting and a small empty box for writing the number.



Four empty circles for counting and a small empty box for writing the number.



Four empty circles for counting and a small empty box for writing the number.



Four empty circles for counting and a small empty box for writing the number.



Four empty circles for counting and a small empty box for writing the number.



Four empty circles for counting and a small empty box for writing the number.



Four empty circles for counting and a small empty box for writing the number.



Four empty circles for counting and a small empty box for writing the number.

# João e o pé de feijão

❖ Pinte as formas geométricas de acordo com a legenda:

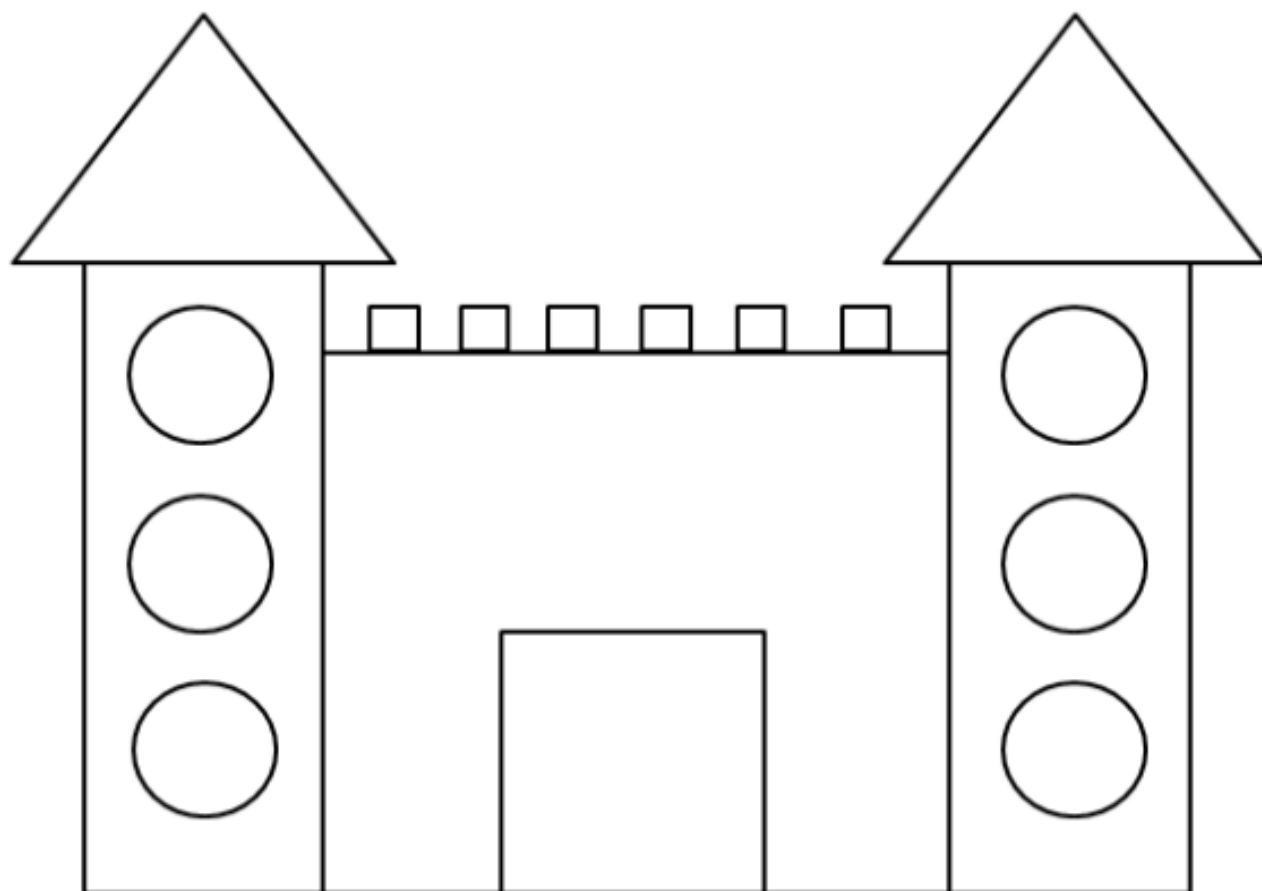

**Legenda:**



# João e o Pé de Feijão

ORGANIZE AS LETRAS E ESCREVA AS PALAVRAS.

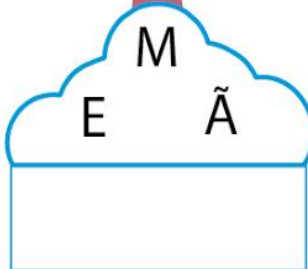
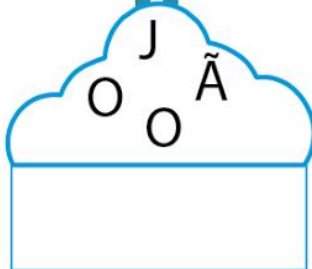



JÁ VIMOS QUE AS PLANTAS TAMBÉM SÃO SERES VIVOS, VAMOS VER NA PRÁTICA COMO ISSO ACONTECE? FAÇA ESSA EXPERIÊNCIA E ACOMPANHE O DESENVOLVIMENTO DO FEIJÃO.

# EXPERIÊNCIA: PÉ DE FEIJÃO



www.smartkids.com.br

## MATERIAL:

- 1 copinho plástico de café
- 1 pedaço de algodão
- 2 ou 3 sementes de feijão



## COMO FAZER:

1. Coloque as sementes de feijão no copinho plástico e cubra com o algodão bem umedecido com água.



3. Não esqueça de umedecer o algodão todos os dias.



2. Deixe o copinho de preferência em um lugar arejado e bem iluminado.

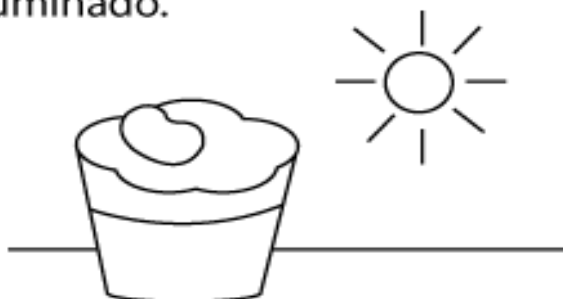

4. Depois de alguns dias você verá o brotinho crescer, mas nunca esqueça de deixar bem molhadinho.



Aprenda brincando com essa experiência!

<https://i.pinimg.com/474x/a8/8e/26/a88e268270175d5b03404214590bd4ad.jpg>

[bandeira-do-brasil.png \(558x805\)www.smartkids.com.br](#)

Atividade independência do Brasil para Educação Infantilwww.educacaoetransformacao.com.br

[http://3.bp.blogspot.com/-7ZCBd5pWH1Y/VbDu8zaDgRI/AAAAAAACXA/5KgTGn7Z6q8/s1600/S%25C3%25ADlabicas\\_J-01.png](http://3.bp.blogspot.com/-7ZCBd5pWH1Y/VbDu8zaDgRI/AAAAAAACXA/5KgTGn7Z6q8/s1600/S%25C3%25ADlabicas_J-01.png)

<https://br.pinterest.com/pin/841750986572962943/>

[http://notebookdaprof.blogspot.com/2015/07/atividades-silabicas-j\\_25.html?m=1](http://notebookdaprof.blogspot.com/2015/07/atividades-silabicas-j_25.html?m=1)

<https://amorensina.com.br/musica-da-familia-do-j-video-e-letra/>

<https://www.smartkids.com.br/atividade/plantar-feijao>

<aartedeensinareaprender.com>