



Prefeitura da Estância Turística de  
**IBIÚNA**  
TRANSFORMAÇÃO RESPONSÁVEL. CUIDANDO DE PESSOAS.



Av. São Sebastião, 192. 4º Piso. Centro. Fones: (15) 3248 1292. 3248 1574. Email: apoiopedagogicosmeibiuna@hotmail.com

ESCOLA: "GUILHERMINA PAULA DOMINGUES" / "JOÃO BATISTA DIAS"

END: AVENIDA NOSSA SENHORA DO CARMO-S/N-BAIRRO CARMO MESSIAS

[TEL: \(15\)3394-1201](tel:(15)3394-1201)

# Dia das Crianças



## APOSTILA DE ATIVIDADES

## PARA CASA

## 3º Bimestre

ALUNO (A): \_\_\_\_\_

Maternal II - B

PROFESSORA: DANIELA

2021

**JA RECONHEÇO A PRIMEIRA  
LETRA DO MEU NOME, POR  
ISSO, COLEI AQUI.**



Plano de aula: 30 de setembro

1- COM TINTA A DEDO, PINTE CADA BALÃO COM A COR INDICADA:

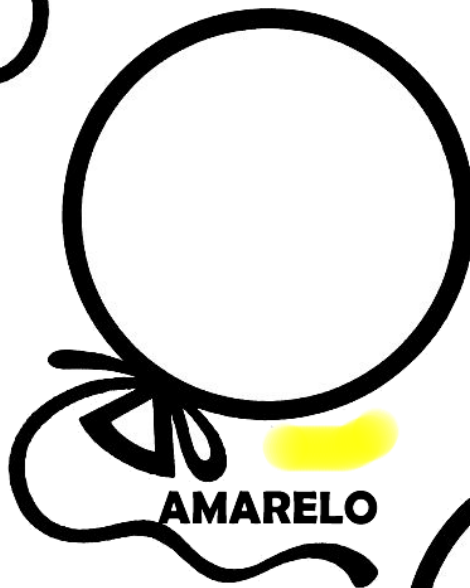
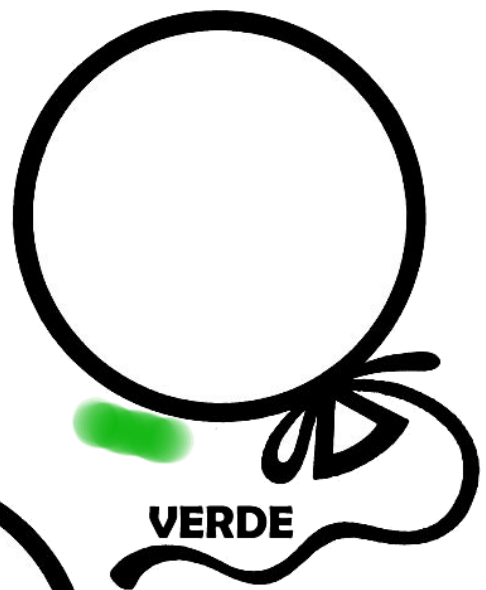
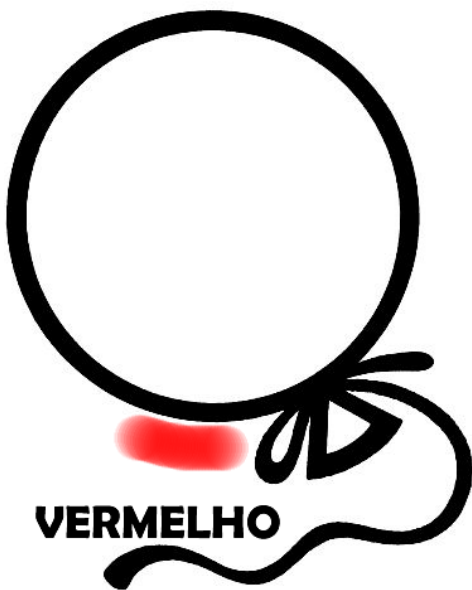



VAMOS LIGAR O NUMERAL 1 AOS  
CONJUNTOS COM UM ELEMENTO?

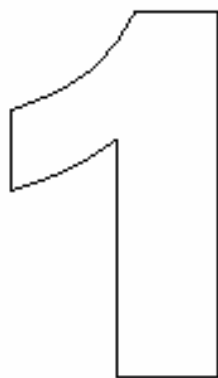
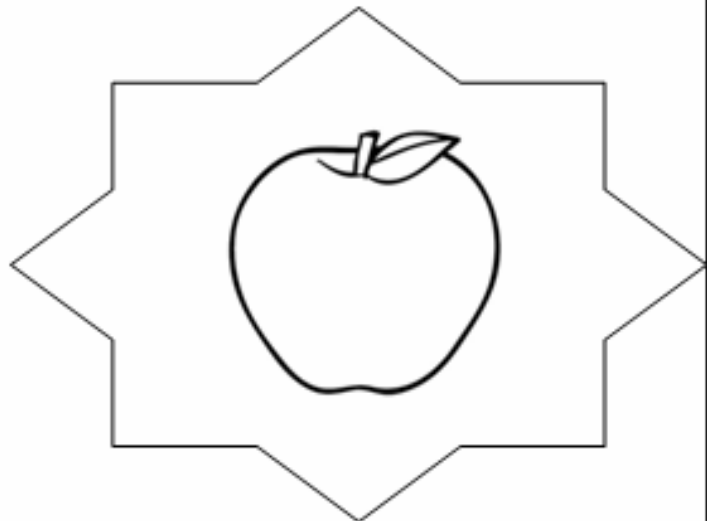
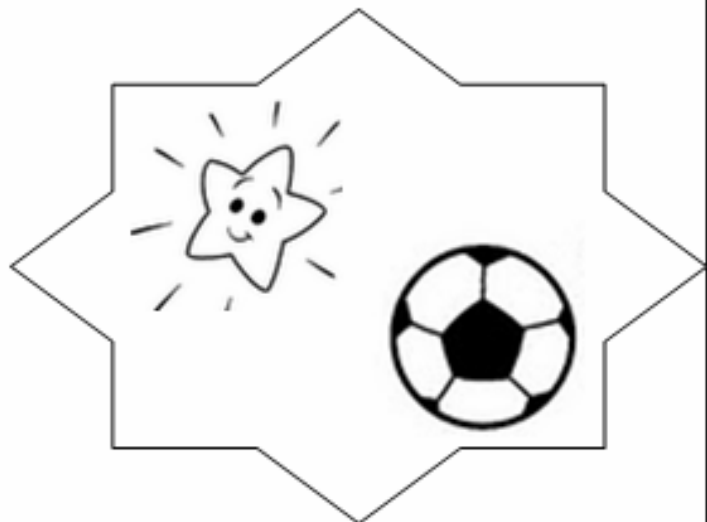

# SEMANA DA CRIANÇA

1- VOCÊ JÁ FEZ ALGUMA DESSAS BRINCADEIRAS?  
CIRCULE AS BRINCADEIRAS QUE VOCÊ CONHECE E MARQUE  
COM UM X, AS QUE VOCÊ JÁ BRINCOU.

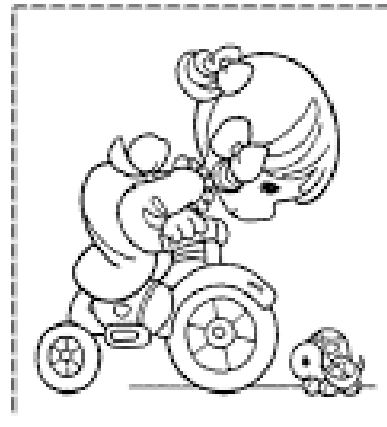
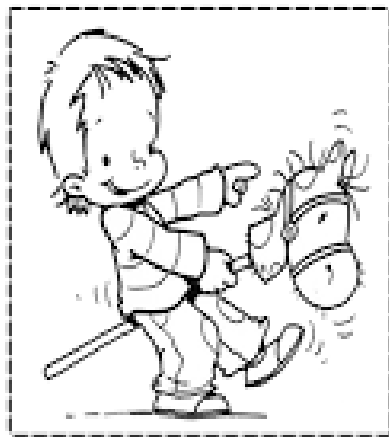
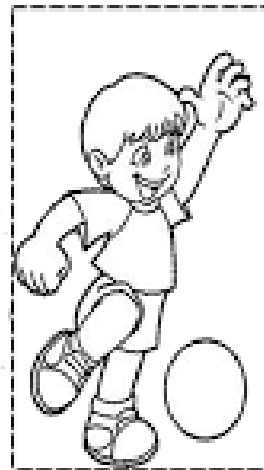
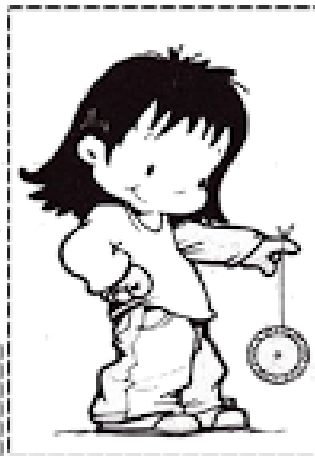

Plano de aula: 05 de outubro

# PROCURE O CAMINHO

LEVE A MENINA ATÉ O SORVETE.

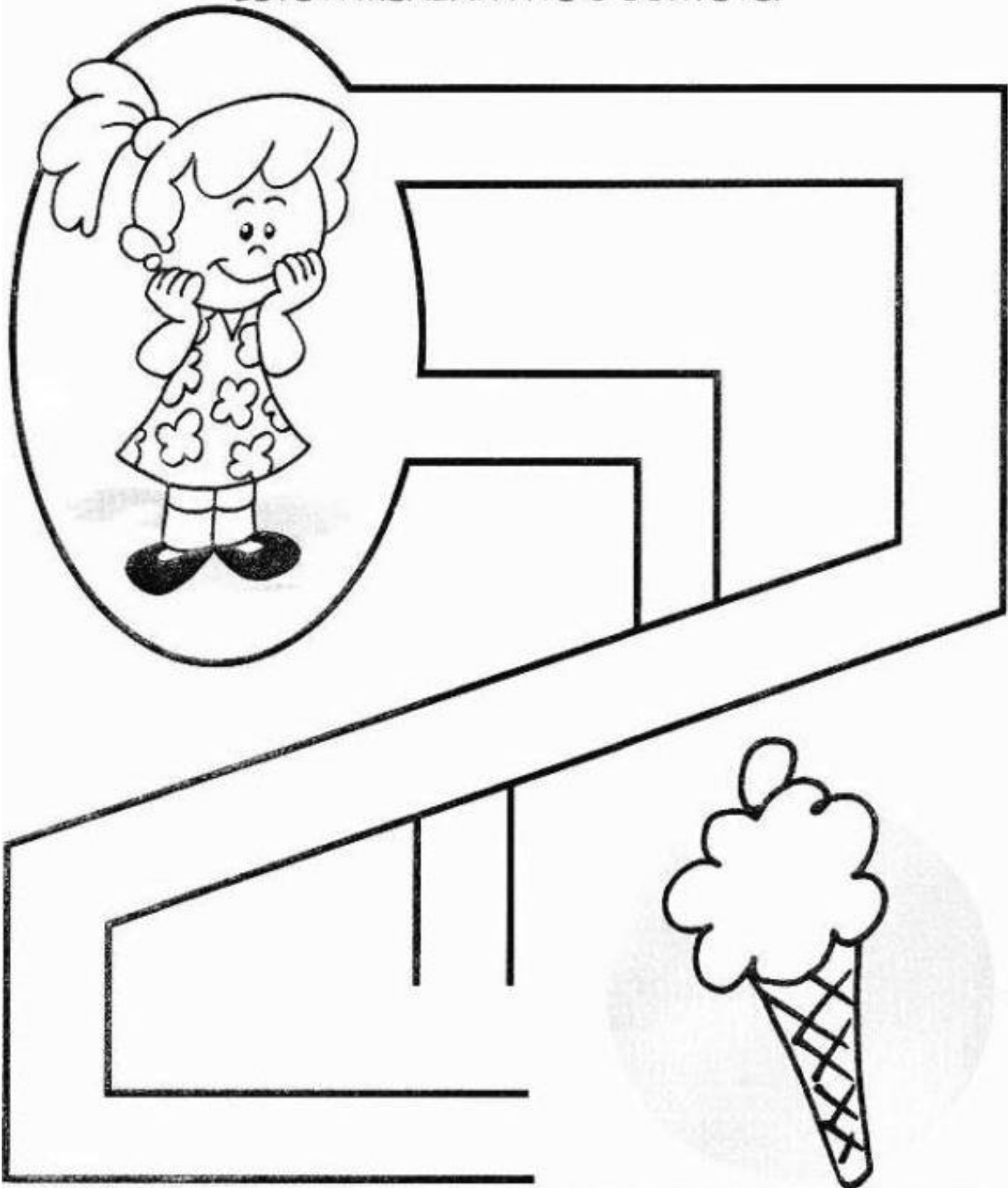

## Plano de aula: 06 de outubro

RECORTE DE REVISTAS E JORNAIS OS PRESENTES QUE VOCÊ DESEJA GANHAR NO DIA DAS CRIANÇAS. COLE-OS NO ESPAÇO ABAIXO.

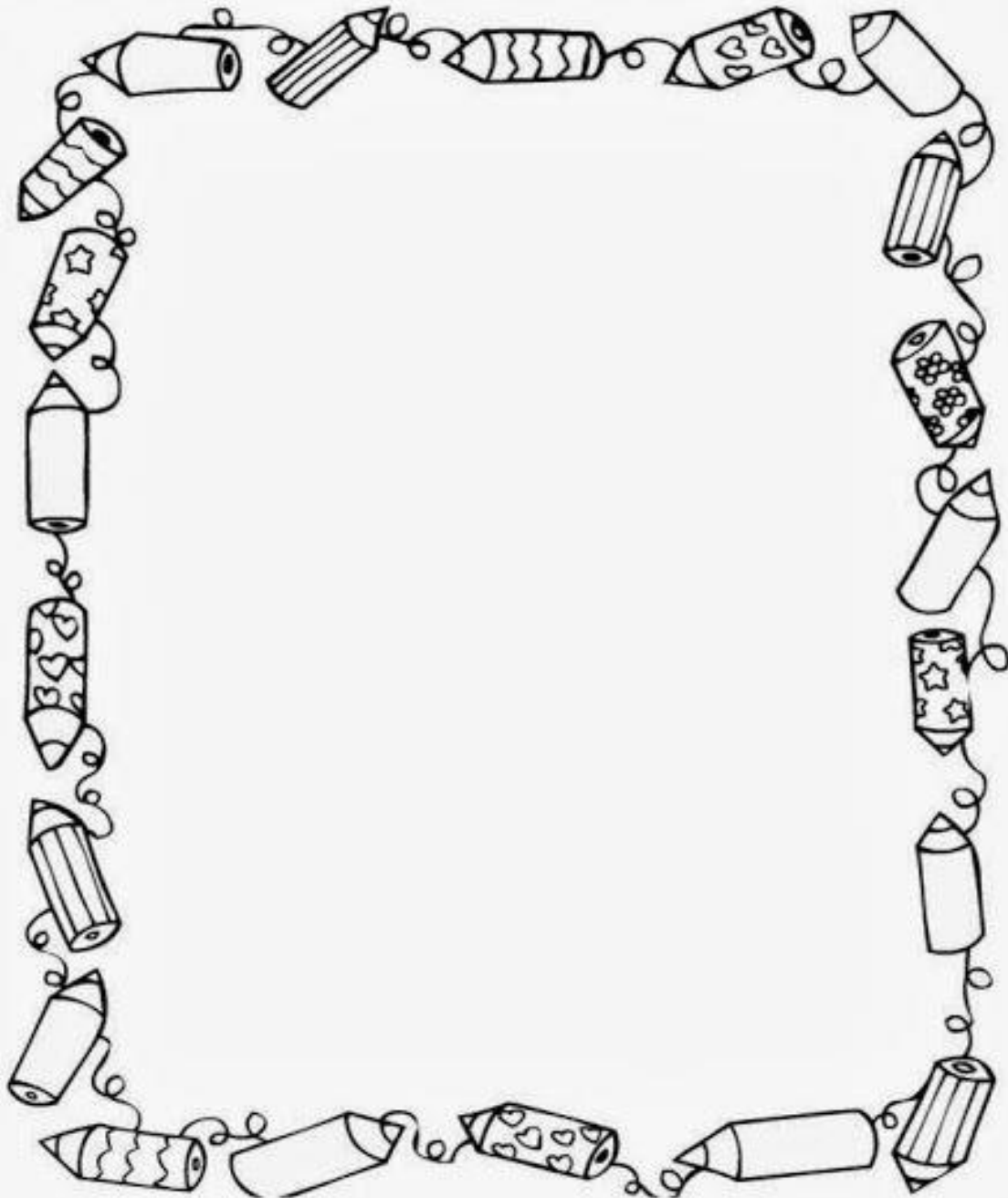

lano de aula: 07 de outubro

# Dia das Crianças

Pinte, recorte e cole os seus brinquedos favoritos dentro da caixa.

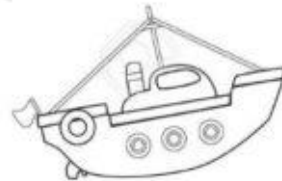
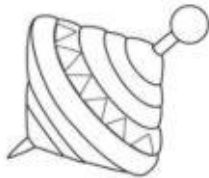
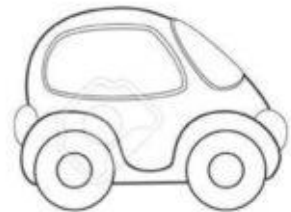
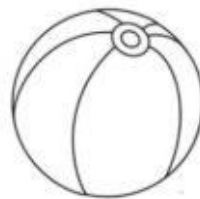
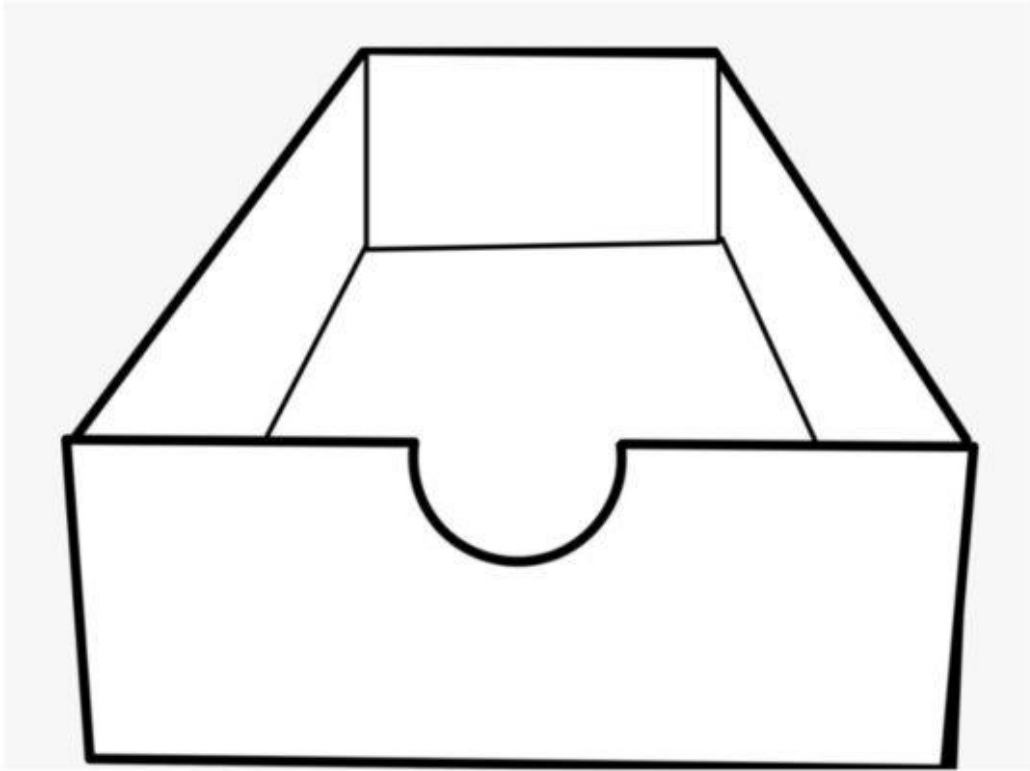



## BRINCANDO COM O BILBOQUÊ

### MATERIAL

- UMA GARRAFA PET COM TAMPA.
- BARBANTE.
- DUREX COLORIDO.
- TESOURA.

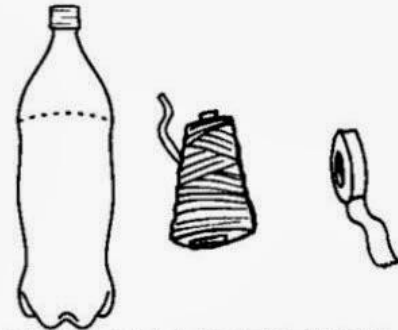

### COMO FAZER

- USE A PARTE DA GARRAFA QUE A PROFESSORA LHE ENTREGOU.



- A PROFESSORA VAI FAZER UM FURO NO MEIO DA TAMPINHA.

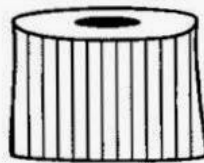

- AMARRE UMA DAS PONTAS DO BARBANTE NO BICO DA GARRAFA. PASSE A OUTRA PONTA DO BARBANTE POR DENTRO DO FURO DA TAMPINHA E DÊ UM NÓ.

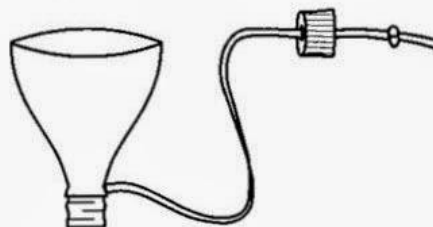

- ENFEITE A GARRAFA COM O DUREX COLORIDO.
- PRONTO! AGORA É SÓ BRINCAR E DIVERTIR-SE BASTANTE!

