

Atividades Remotas 13

Escola: E.M Criança Feliz "Profª. Vitória Evany Miguel Cordeiro"



Nome: _____ - Fase II - G

(Professora: Fernanda Lemos da Silva)

Data de Entrega: 08/11/2021

(Período: 18/10/21 a 05/11/21).

Senhores Pais ou Responsáveis

Devido a pandemia do covid-19 (Coronavírus), que atinge o mundo nesse momento, foi necessárias adaptações para que os alunos continuem com a aprendizagem em casa, e o papel da família será de suma importância, segue aqui nessa apostila atividades datadas que se possível deverão ser realizadas no respectivo dia da reposição.

Atenção

Orientações Gerais para a realização das atividades.

- ✓ As atividades estão datadas;
- ✓ Realizar a leitura de todas as atividades junto com a criança;
- ✓ Explicar ao aluno o que será necessário ser feito, cada atividade traz orientações de como serem realizadas;
- ✓ Solicitar aos alunos que realizem a pintura bem caprichada dos desenhos, inclusive da capa;
- ✓ Na medida do possível registrar com fotos ou vídeos e enviar no grupo da sala, pelo WhatsApp;
- ✓ Pedimos a gentileza de cuidarem dessas atividades, pois as mesmas terão que ser devolvidas;
- ✓ É muito importante o treino e escrita do nome e data em todas as atividades solicitadas, evitando assim dificuldades futuras.

Aqui deixamos nosso agradecimento e admiração por cada família, pelo empenho e esforço realizado em casa.

Qualquer dúvida, estou à disposição!

Atenciosamente, Prof^a. Fernanda.

NA ESCOLA, É ROTINA, AS CRIANÇAS APRENDEREM SOBRE DIA, SEMANA E MÊS, SEGUIE O CALENDÁRIO DO MÊS DE OUTUBRO E NOVEMBRO, PARA QUE OS DIAS SEJAM COLORIDOS DE ACORDO COM A DATA DE CADA ATIVIDADE, OBSERVANDO COM A CRIANÇA QUE AOS FINAIS DE SEMANA NÃO TEM ATIVIDADE.



CALENDÁRIO 2021

DATAS COMEMORATIVAS DO MÊS 

12- PADROEIRA DO BRASIL

OUTUBRO

DOM	SEG	TER	QUA	QUI	SEX	SAB
17	18	19	20	21	22	23
24	25	26	27	28	29	30
31						



CALENDÁRIO 2021

DATAS COMEMORATIVAS DO MÊS 

02 – FINADOS 15 PROCLAMAÇÃO DA REPÚBLICA
20 – CONSCIÊNCIA NEGRA

NOVEMBRO

DOM	SEG	TER	QUA	QUI	SEX	SAB
	1	2	3	4	5	6

NOME: _____ - DATA: _____



KEIKA

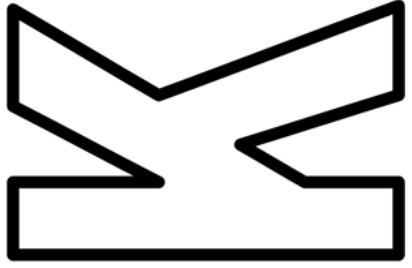

KIBON

VAMOS COBRIR O PONTILHADO:

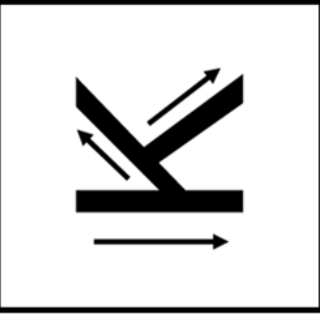

VAMOS, AGORA, COMPLETAR AS PALAVRAS:

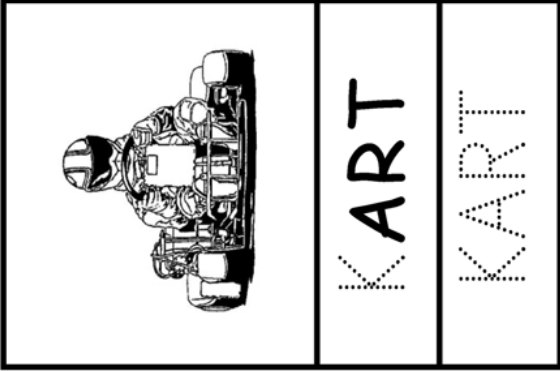

KART

KART

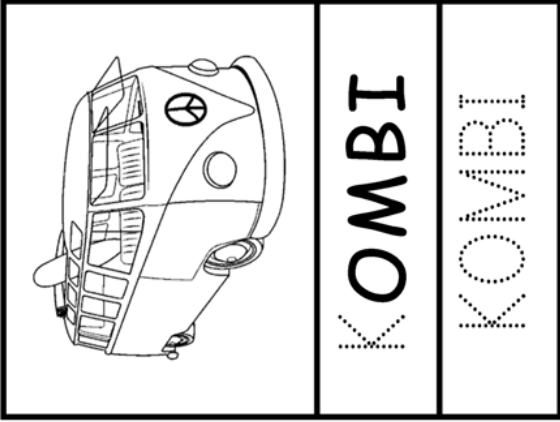

KOMBI

KOMBI

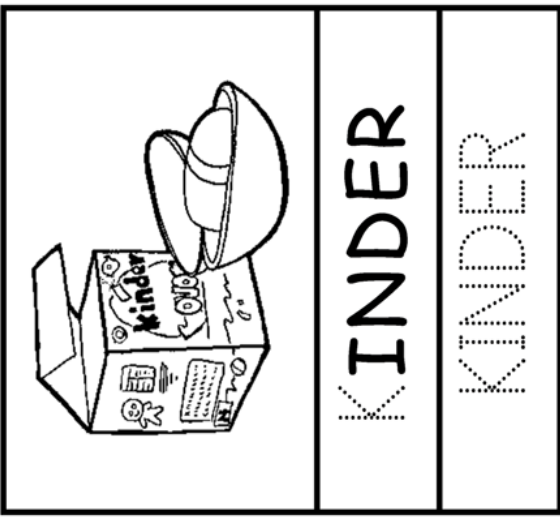

KINDER

KINDER

QUAIS PALAVRAS COMEÇAM COM A LETRA K?

VAMOS PINTAR AS FICHAS!

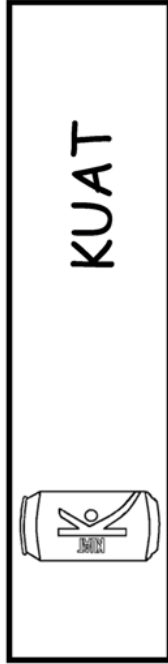

KUAT

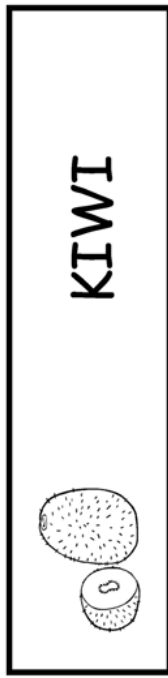

KIWI

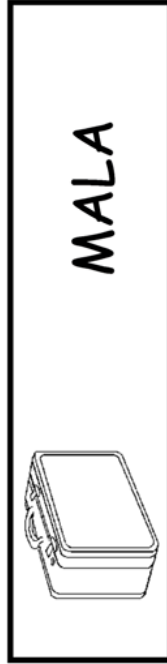

MALA

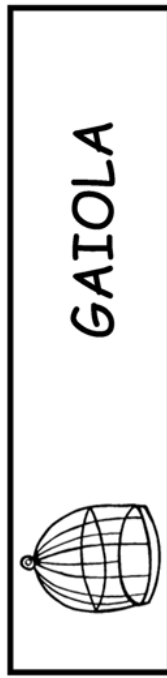

GAIOLA

Atividade – Data: 20/10/2021

ANTES DE REALIZAR A ATIVIDADE, ASSISTIR O VÍDEO.

SUGESTÃO DE VÍDEO: <https://www.youtube.com/watch?v=Dm1V2p8Ih80>

A dona faixa (Vídeo Oficial)

Atividade

I-LIGUE AS IMAGENS COM OS SEUS RESPECTIVOS NOMBES:

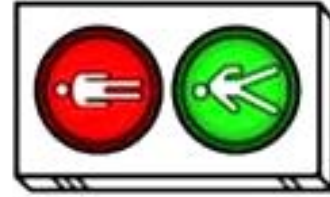
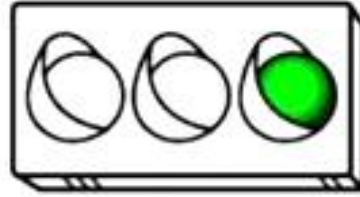
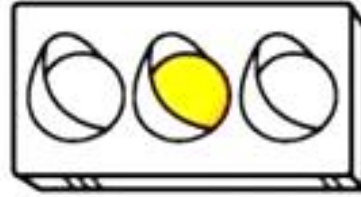
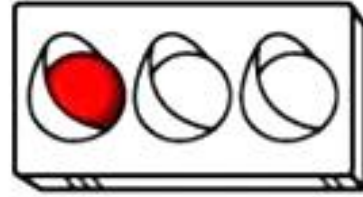

a. **PEDESTRES**

b. **ATENÇÃO**

c. **SIGA**

d. **PARE**

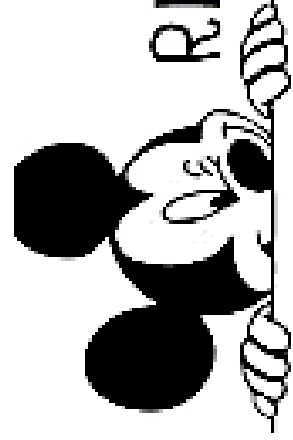

CONTE, RECORTE e COLE

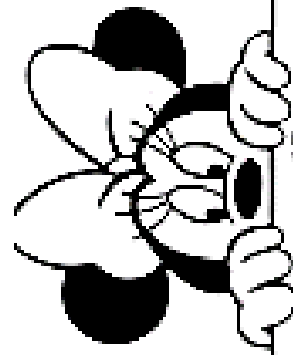

1- RECORTE E COLE SOBRE CADA JOANINHA,
O NUMERAL QUE REPRESENTA A QUANTIDADE DE
BOLINHAS EM SUAS ASINHAS.

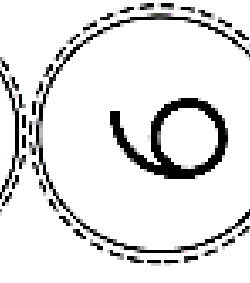
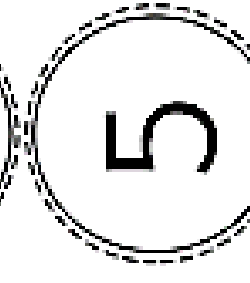
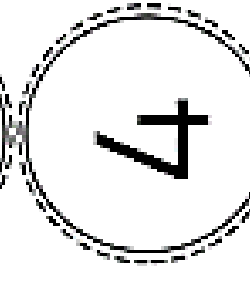
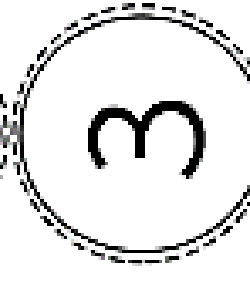
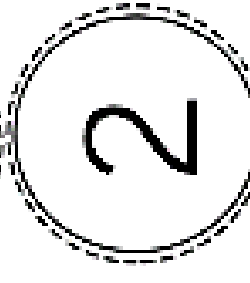
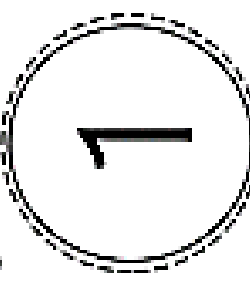
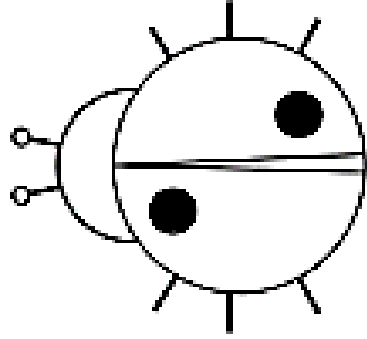
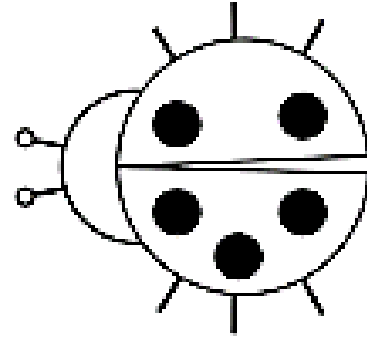
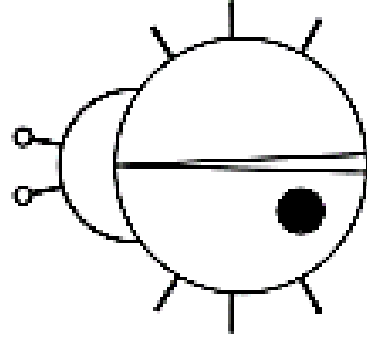
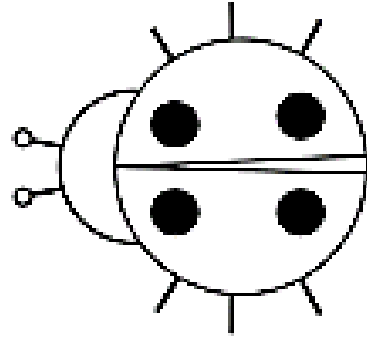
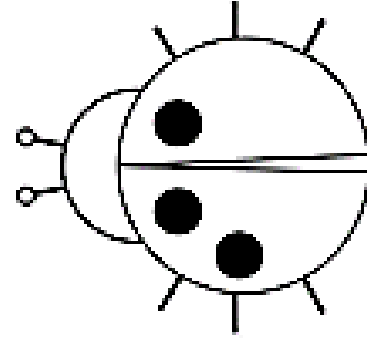
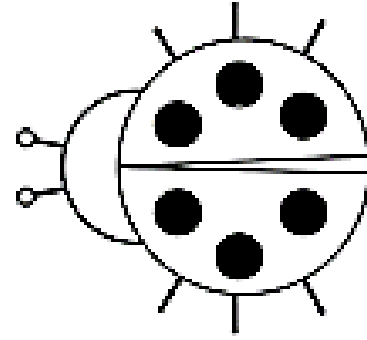

PINTE OS QUADROS QUE TENHAM PALAVRAS
ESCRITAS COM A LETRA **K**.

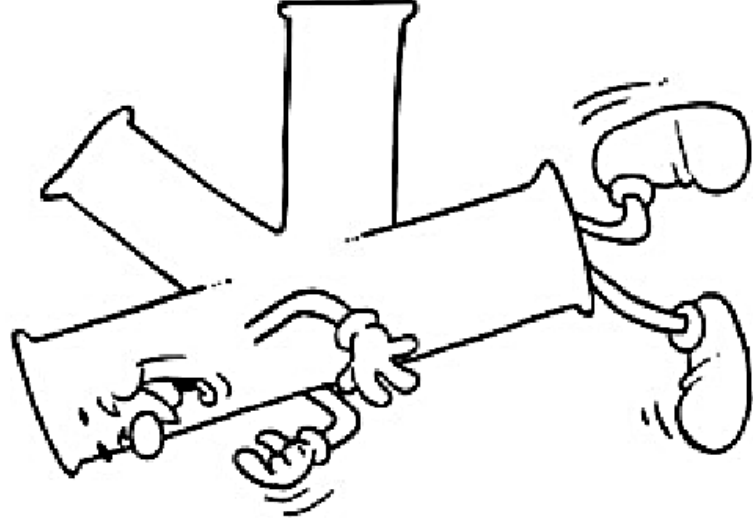

BOCA

KIWI

KARINA

CORAÇÃO

KETCHUP

KÁTIA

KARAOKE

COMETA

KART

KIBOM

CAIO

KLÉBER

NOME: _____

- DATA: _____

FAÇA UM X NOS QUE VOAM



NOME: _____

- DATA: _____



LUCA

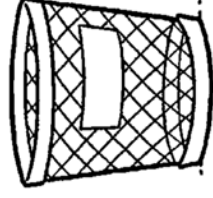
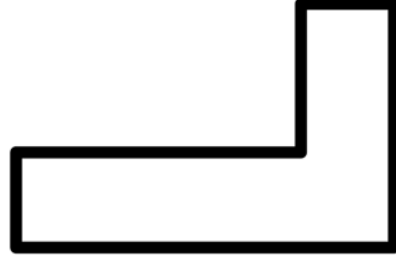

LIXO

VAMOS COBRIR O PONTILHADO:

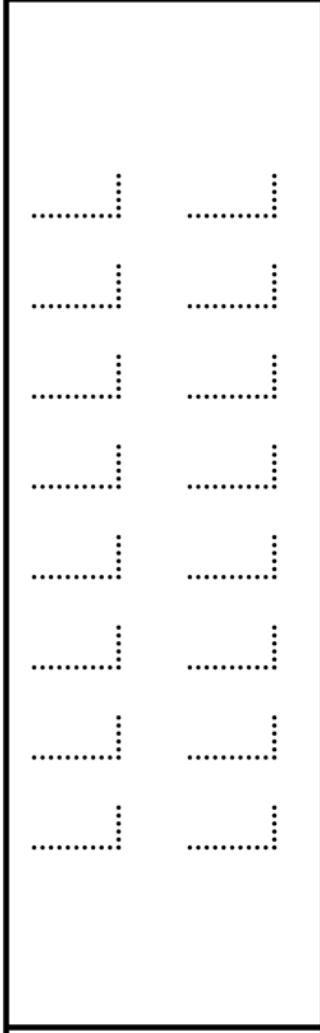
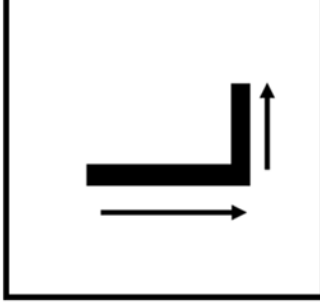

VAMOS, AGORA, COMPLETAR AS PALAVRAS:

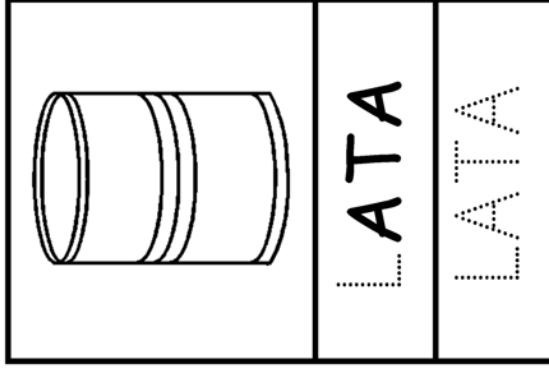

LATA

LATA

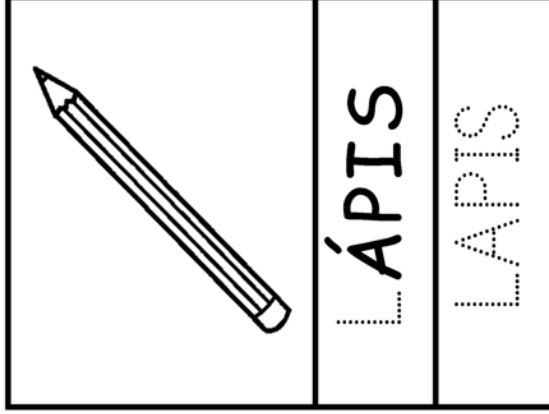

LÁPIS

LÁPIS

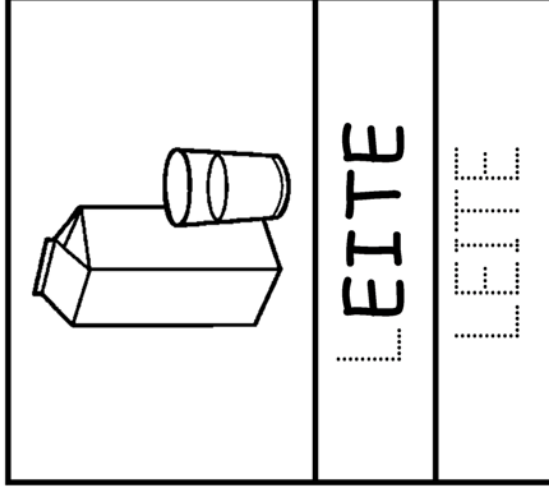

LEITE

LEITE

QUAIS PALAVRAS COMEÇAM COM A LETRA L?

VAMOS PINTAR AS FICHAS!

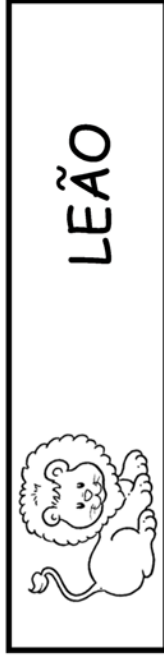

LEÃO

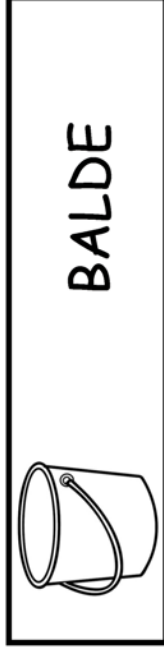

BALDE

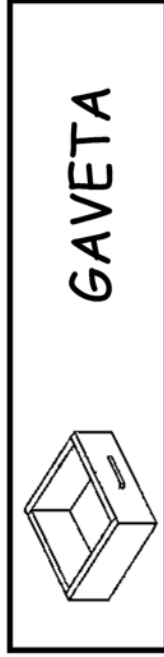

GAVETA

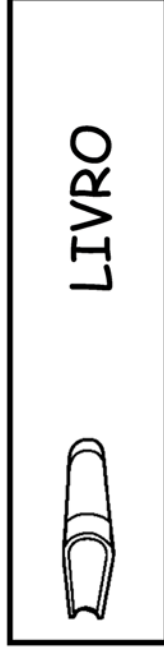

LIVRO

ALIMENTAÇÃO SAUDÁVEL

AS FRUTAS SÃO PEÇAS FUNDAMENTAIS NUMA ALIMENTAÇÃO SAUDÁVEL E DEVEM SER CONSUMIDAS DIARIAMENTE. ELAS FORNECEM VITAMINAS, MINERAIS E DIFERENTES FIBRAS ALIMENTARES.

CONTE QUANTAS LETRAS TEM CADA PALAVRA E REGISTRE NOS QUADRADINHOS.



MELANCIA

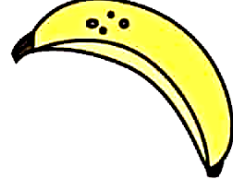

BANANA

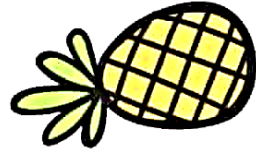

ABACAXI



MORANGO

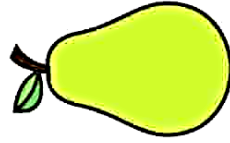

PERA

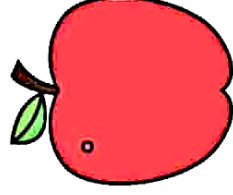

MAÇA

NOME: _____ DATA: _____

- COMPLETE AS LISTRAS DO CORPO DA ABELHA E DEPOIS VAMOS COLORIR.

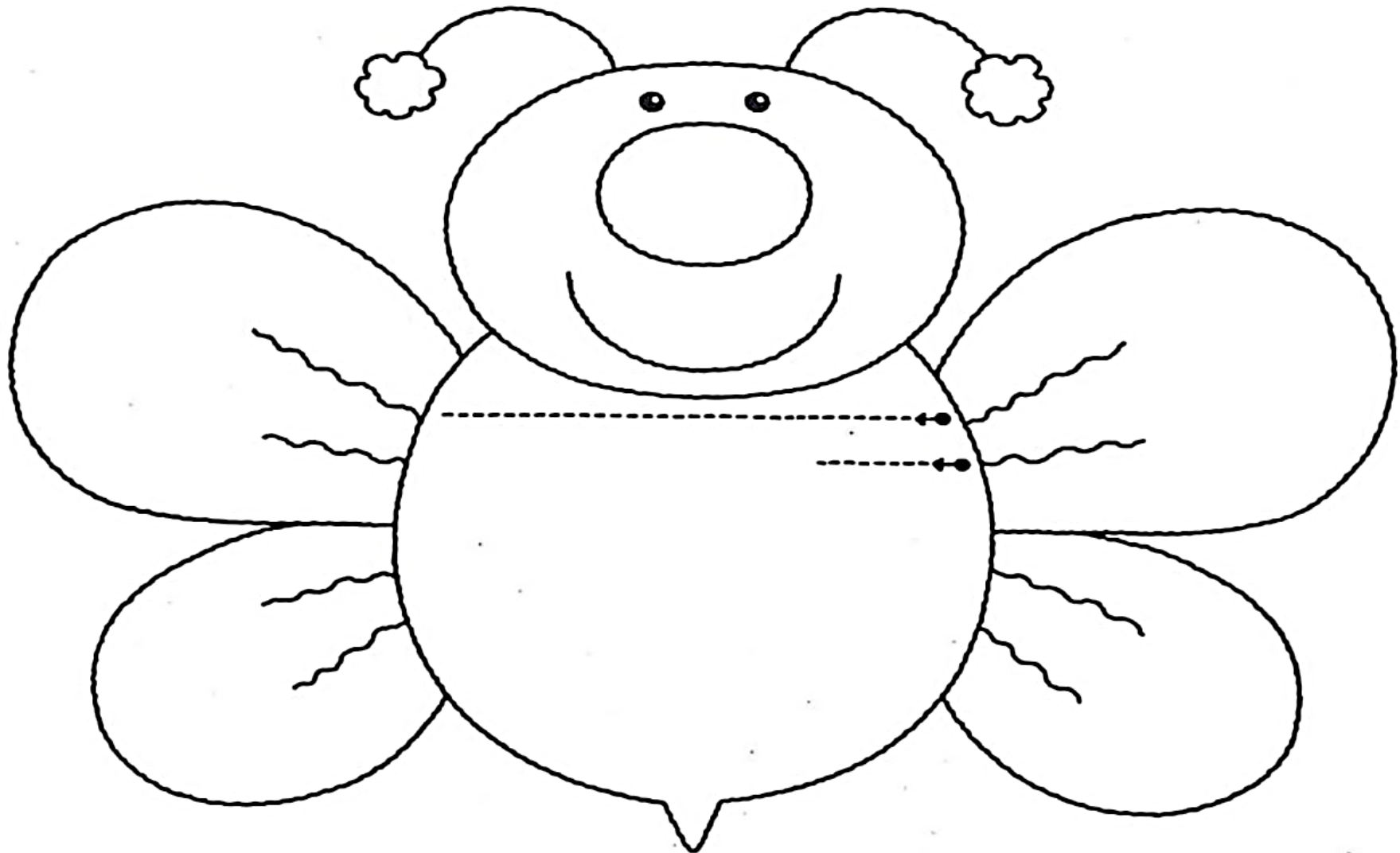

Atividade – Data: 29/10/2021

BRINCADEIRA: TELEFONE SEM FIO



DE PREFERÊNCIA EM FILA, UM AO LADO DO OUTRO, AS CRIANÇAS TRANSMITEM UMA MENSAGEM NO OUVIDO DA PESSOA DA FAMÍLIA QUE ESTÁ MAIS PRÓXIMA.

A MENSAGEM PODE SER UMA PALAVRA OU FRASE ESCOLHIDA POR QUEM ESTÁ NA PONTA, OU SUGERIDA POR OUTRA PESSOA. INICIADO O JOGO, OS PARTICIPANTES TÊM QUE DIZER AO OUVIDO A MENSAGEM ESCOLHIDA E TRANSMITIR PARA QUEM ESTÁ AO SEU LADO.

SE ALGUÉM NÃO ENTENDER BEM A MENSAGEM TEM QUE DIZER MESMO ASSIM, UMA VEZ QUE A MESMA NÃO PODE SER REPETIDA. AS MENSAGENS COSTUMAM SER MODIFICADAS AO LONGO DO JOGO, E O ÚLTIMO FALA EM VOZ ALTA O RESULTADO FINAL.

COMPLETE AS PALAVRAS COM A CONSOANTE L.

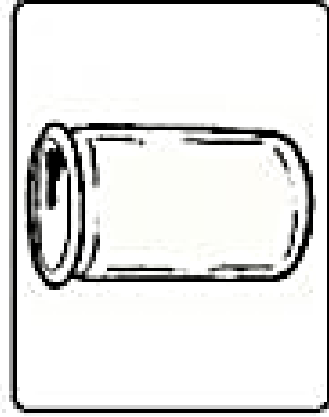

__ATA

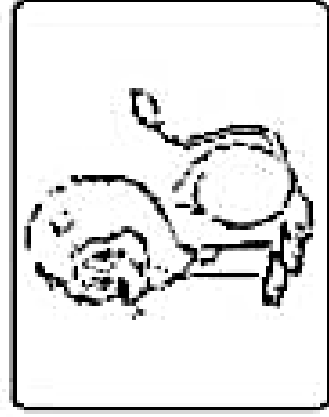

__EÃO

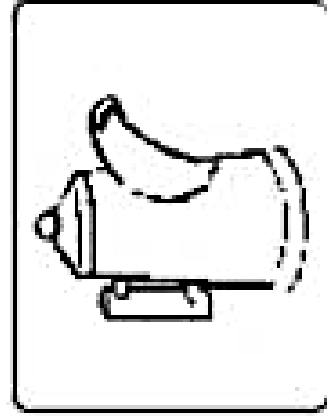

BU__E

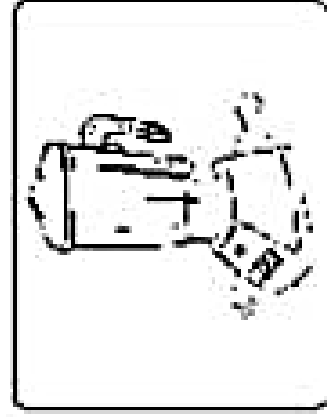

__IQUIDIFICADOR



__UA

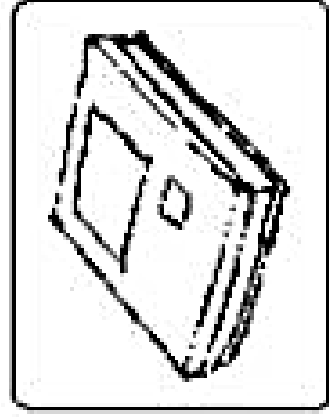

__IVRO

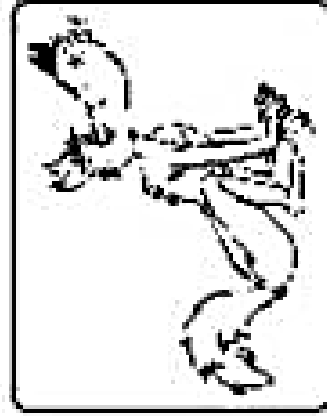

__OBO

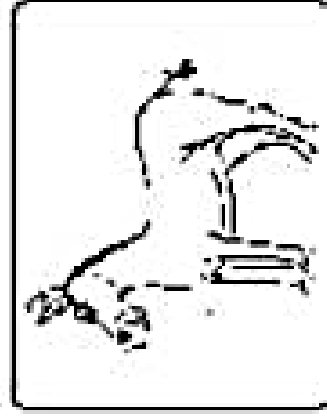

MU__A

Circle os meios de transporte que você já utilizou.

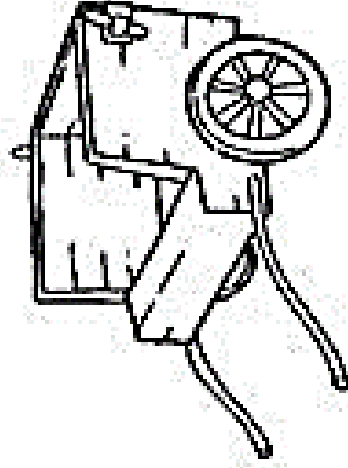
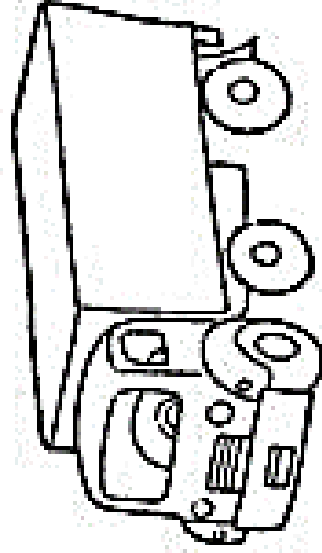
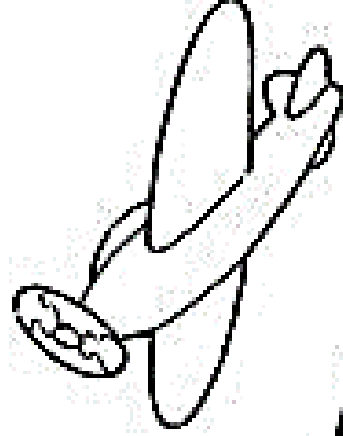
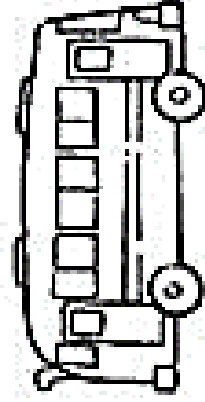
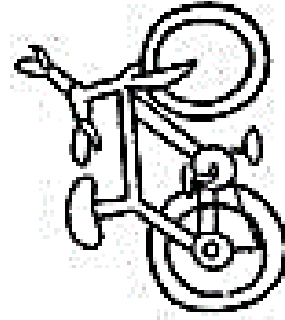
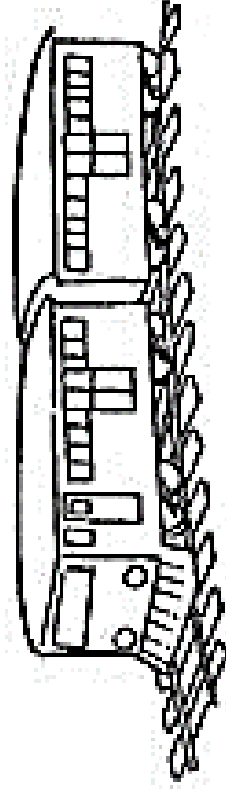
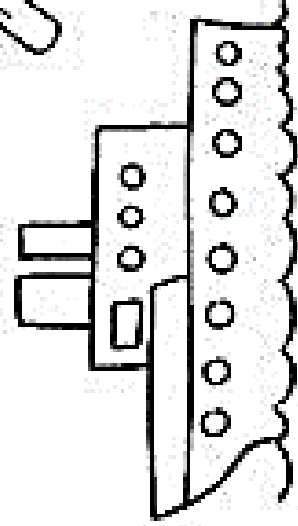
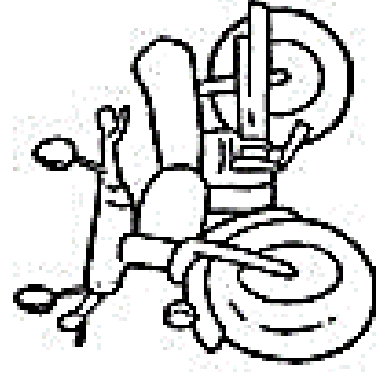
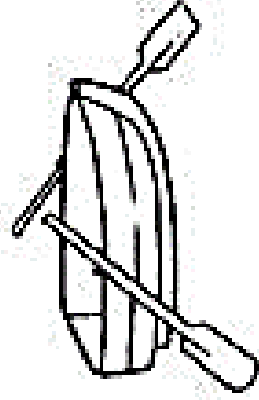
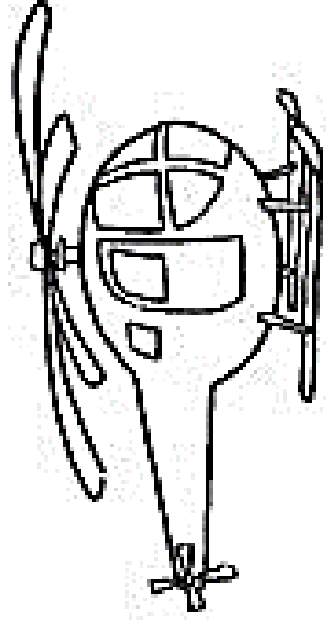
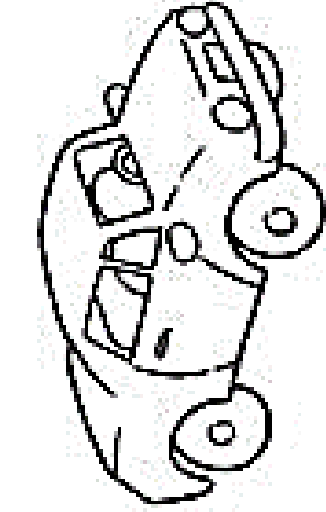

JOGO DOS 5 ERROS

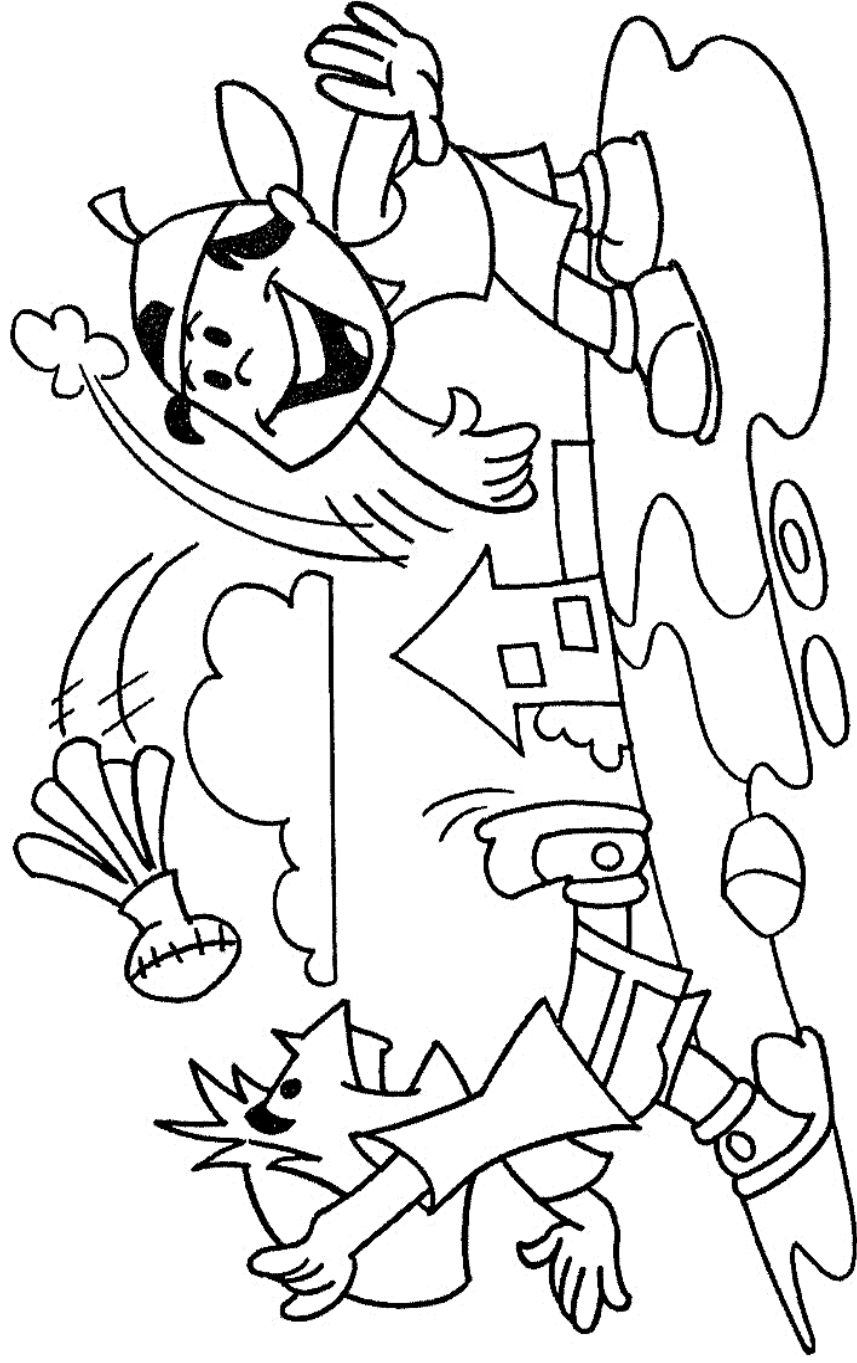

FONTES:

- Capa - <https://onlinecursosgratuitos.com/80-atividades-dia-das-criancas-para-imprimir-educacao-infantil-e-maternal/> - ACESSO DIA: 03/10/2021;
- 1 - <https://br.pinterest.com/pin/498632989999508697/> - ACESSO DIA: 03/10/2021;
- 1 - <https://israelakotona.blogspot.com/2020/11/calendario-2021-patrolha-canina.html> - ACESSO DIA: 03/10/2021;
- 2 - http://3.bp.blogspot.com/-Gc_tu2cCalo/Tb8HxmmJgRI/AAAAAAAAAgkw/hj2S2ldOLrs/s1600/LETRA+K.png - ACESSO DIA: 03/10/2021;
- 3 - <https://br.pinterest.com/pin/610871136952576599/> - ACESSO DIA: 03/10/2021;
- 3 - <https://www.youtube.com/watch?v=DmlV2p8Ih80> - ACESSO DIA: 03/10/2021;;
- 4 - <https://www.aartedeensinareaprender.com/2019/04/atividade-pronta-quantidade-com-recorte.html> - ACESSO DIA: 03/10/2021;
- 5 - <https://www.educacaoetransformacao.com.br/wp-content/uploads/2018/04/atividades-com-a-letra-k-pinte-o-quadrado.png> - ACESSO DIA: 03/10/2021;
- 6 - <https://acessaber.com.br/atividades/atividades-sobre-os-animais/> - ACESSO DIA: 03/10/2021;
- 7 - <http://4.bp.blogspot.com/-ZI2j-8aDSXg/Tb8H0GRRv9I/AAAAAAAAAgk0/9FsPXC4Buyw/s1600/LETRA+L.png> - ACESSO DIA: 03/10/2021;
- 8 - <https://atividadespedagogicas.net/wp-content/uploads/2017/10/alimentacao-saudavel-desenhe-714x1024.jpg> - ACESSO DIA: 03/10/2021;
- 9 - <https://www.cantinhoapoeticoepedagogico.com.br/2018/01/atividades-de-coordenacao-motora-fina.html> - ACESSO DIA: 03/10/2021;
- 10 - <https://www.todamateria.com.br/jogos-populares/> – ACESSO DIA: 03/10/21;
- 11 - <http://www.professorzezinhoramos.com/2013/06/atividades-com-letra-l.html> - ACESSO DIA: 03/10/21;
- 12 - <https://br.pinterest.com/pin/845902742510896146/> - ACESSO DIA: 03/10/21;
- 13 - <http://franmessias.blogspot.com/2011/05/jogo-dos-erros.html> - ACESSO DIA: 03/10/21;