

Atividades Remotas 13

Escola: E.M Criança Feliz "Profª. Vitória Evany Miguel Cordeiro"

Dia das crianças

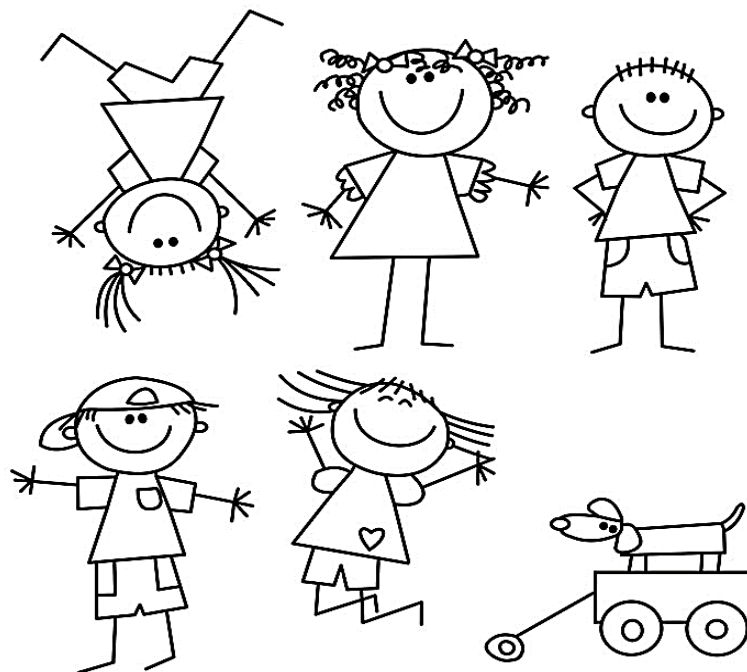

Nome: _____ - Fase II - A

(Professora: Milene Cristina de Oliveira Soares)

Data de Entrega: 08/11/2021

(Período: 18/10/21 a 05/11/21).

Senhores Pais ou Responsáveis

Devido a pandemia do covid-19 (Coronavírus), que atinge o mundo nesse momento, foi necessárias adaptações para que os alunos continuem com a aprendizagem em casa, e o papel da família será de suma importância, segue aqui nessa apostila atividades datadas que se possível deverão ser realizadas no respectivo dia da reposição.

Atenção

Orientações Gerais para a realização das atividades.

- ✓ As atividades estão datadas;
- ✓ Realizar a leitura de todas as atividades junto com a criança;
- ✓ Explicar ao aluno o que será necessário ser feito, cada atividade traz orientações de como serem realizadas;
- ✓ Solicitar aos alunos que realizem a pintura bem caprichada dos desenhos, inclusive da capa;
- ✓ Na medida do possível registrar com fotos ou vídeos e enviar no grupo da sala, pelo WhatsApp;
- ✓ Pedimos a gentileza de cuidarem dessas atividades, pois as mesmas terão que ser devolvidas;
- ✓ É muito importante o treino e escrita do nome e data em todas as atividades solicitadas, evitando assim dificuldades futuras.

Aqui deixamos nosso agradecimento e admiração por cada família, pelo empenho e esforço realizado em casa.

Qualquer dúvida, estou à disposição!

Atenciosamente, Prof^ª. Milene.

SEGUE O CALENDÁRIO DO MÊS DE OUTUBRO E NOVEMBRO, PARA QUE OS DIAS SEJAM COLORIDOS DE ACORDO COM A DATA, OBSERVANDO COM A CRIANÇA QUE AOS FINAIS DE SEMANA NÃO TEM ATIVIDADE.

CALENDARIO
2021



OUTUBRO

DATAS COMEMORATIVAS DO MÊS

12 – PADROEIRA DO BRASIL



DOM	SEG	TER	QUA	QUI	SEX	SAB
17	18	19	20	21	22	23
24	25	26	27	28	29	30
31						

CALENDÁRIO
2021



DATAS COMEMORATIVAS DO MÊS

02 – FINADOS 15 PROCLAMAÇÃO DA REPÚBLICA
20 – CONSCIÊNCIA NEGRA



NOVEMBRO

DOM	SEG	TER	QUA	QUI	SEX	SAB
	1	2	3	4	5	6

NOME: _____ - DATA: _____



KEIKA

K



KIBON

VAMOS COBRIR O PONTILHADO:

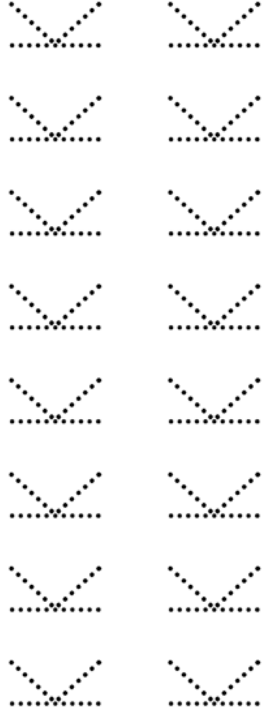
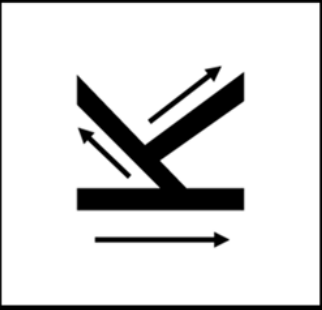

VAMOS, AGORA, COMPLETAR AS PALAVRAS:

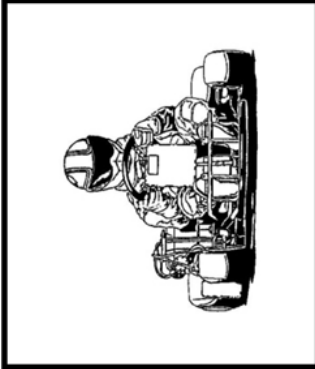

KART

KART

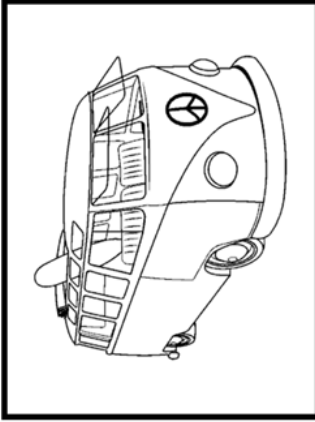

KOMBI

KOMBI

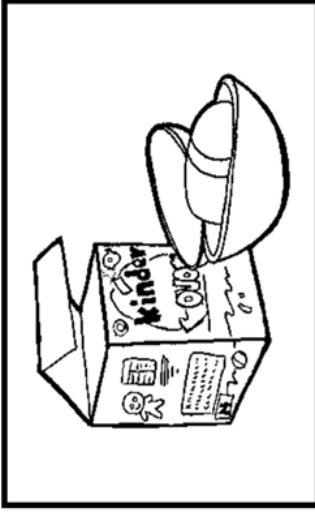

KINDER

KINDER

QUAIS PALAVRAS COMEÇAM COM A LETRA K?

VAMOS PINTAR AS FICHAS!

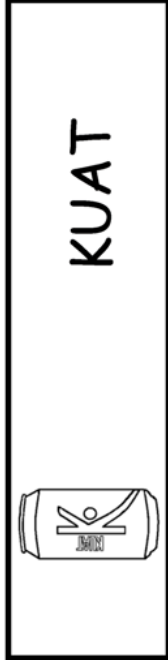

KUAT

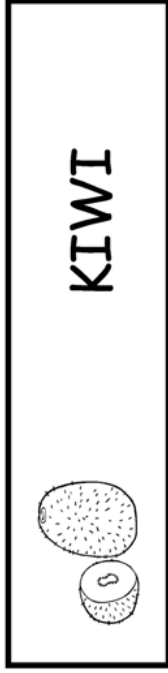

KIWI

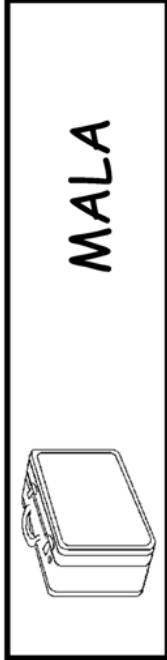

MALA

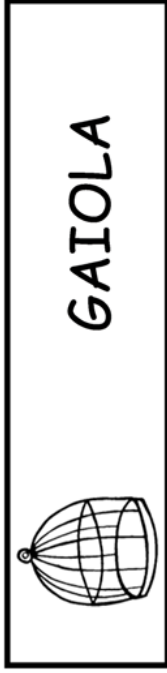

GAIOLA

Atividade – Data: 20/10/2021

ANTES DE REALIZAR A ATIVIDADE, ASSISTIR O VÍDEO.

SUGESTÃO DE VÍDEO: <https://www.youtube.com/watch?v=kIzkRjTZjhE> - Aprendendo | Semáforo

1- Pinte o semáforo para carros nas cores indicadas e ligue corretamente

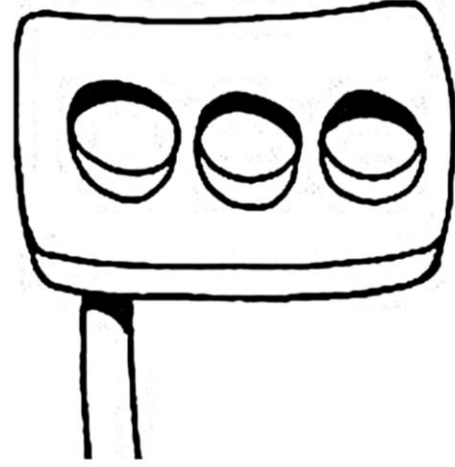

VERMELHO

ATENÇÃO

AMARELO

PODE PASSAR

VERDE

PARE!

2- Pinte o semáforo que indica que podemos atravessar a rua.

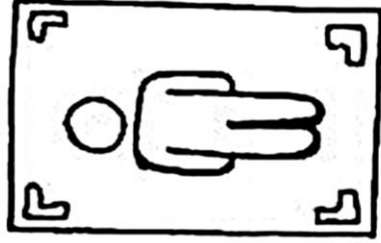



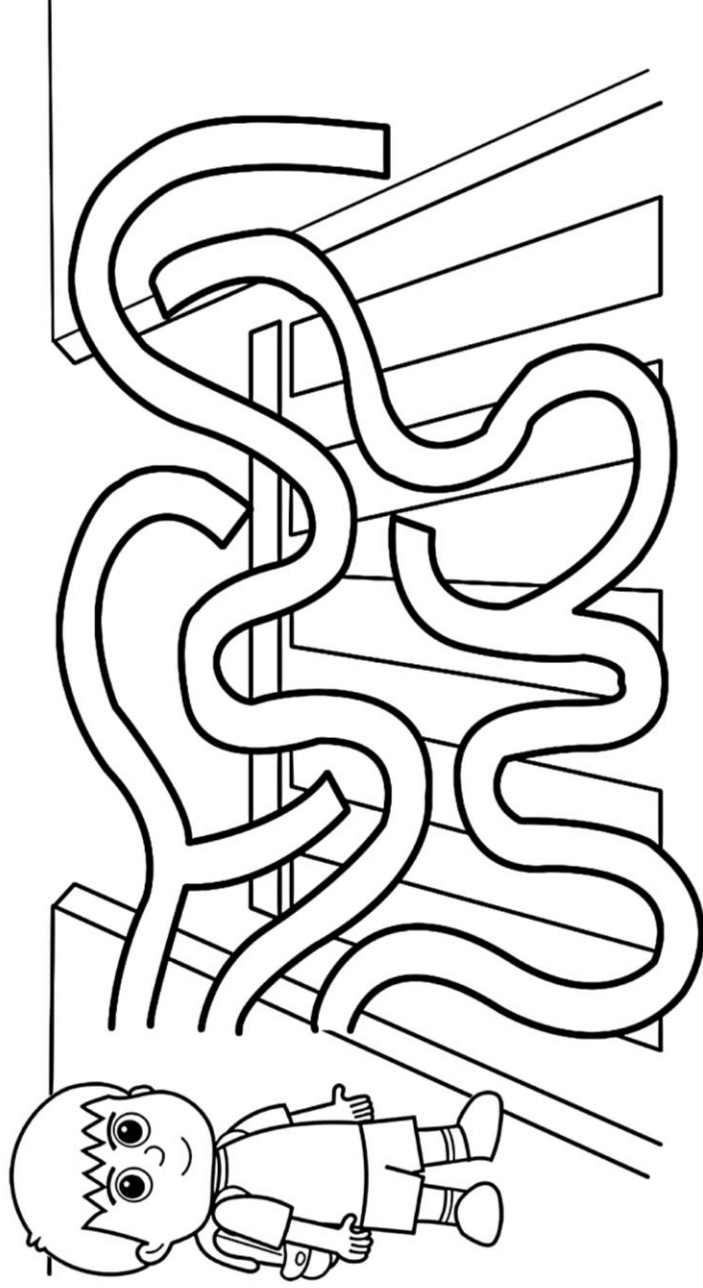





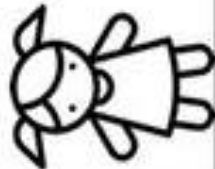



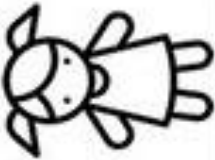





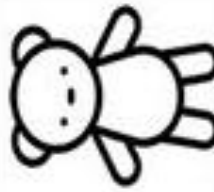
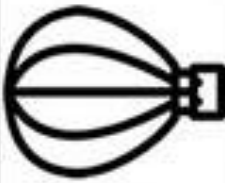

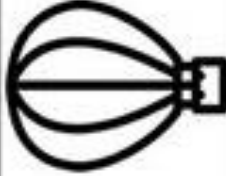
3- Ajude Pedro a chegar em segurança do outro lado da rua:



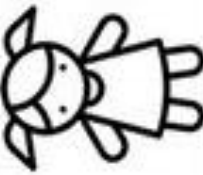

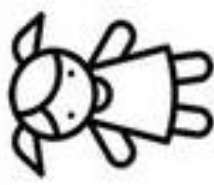
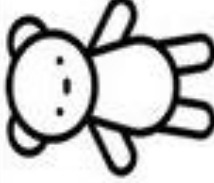
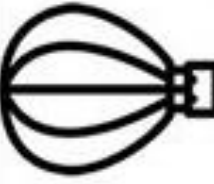
QUANTOS SÃO?

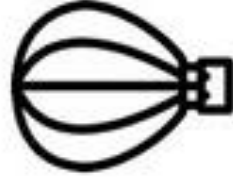
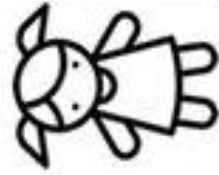

CIRCULE TODAS AS LETRAS **K** QUE APARECEM NO CAÇA-LETRAS.

G	F	K	A	U	H
D	K	U	H	O	I
K	I	W	A	K	D
O	A	H	D	A	K
D	H	A	K	I	H
I	K	D	H	U	E
H	A	E	K	D	I
A	D	W	U	H	K

COBERTURA DO CORPO DOS ANIMAIS

As coberturas dos corpos dos animais são diferentes. Alguns animais têm o corpo coberto de pêlos. Outros têm o corpo coberto de penas. Outros ainda têm o corpo coberto de escamas.

 Vamos ligar?

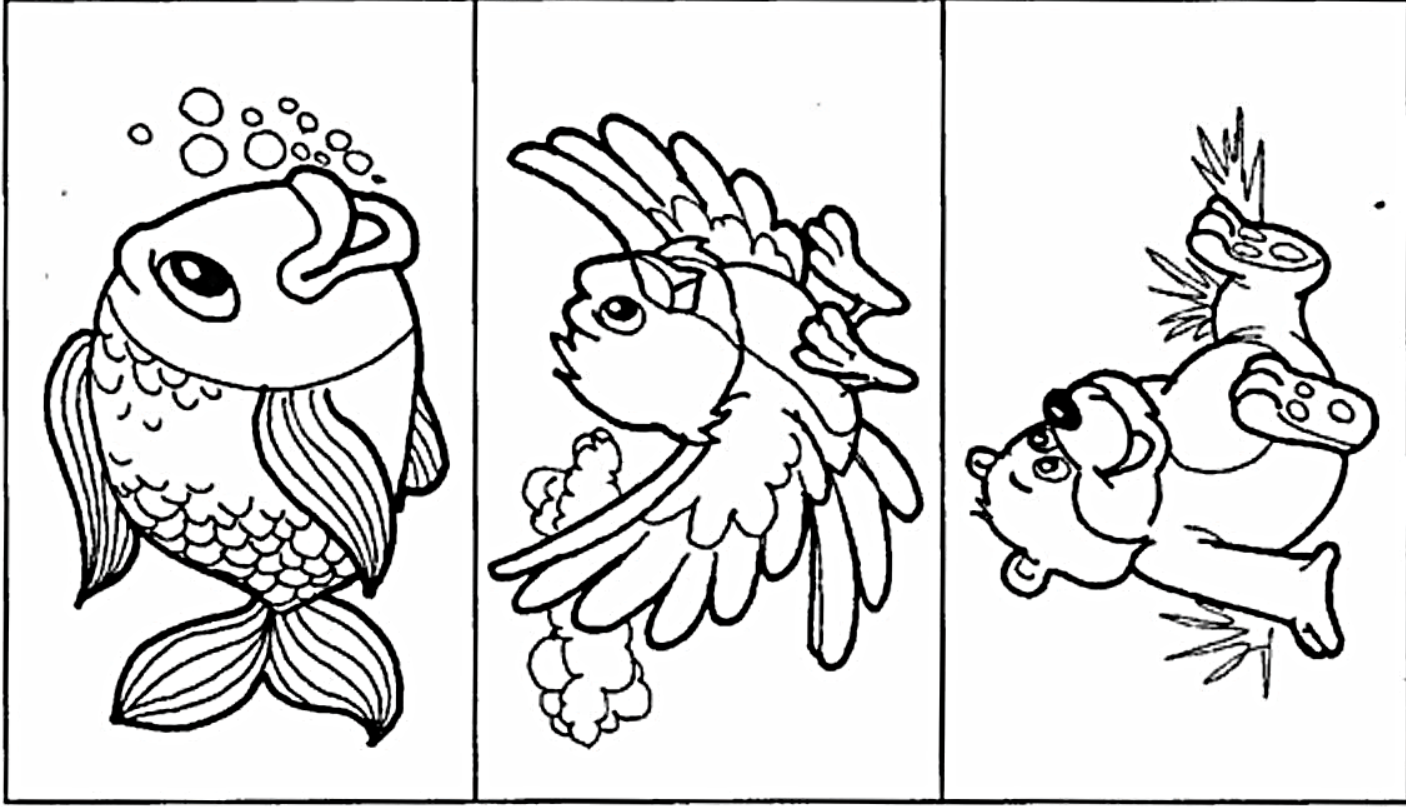

PENAS

PÊLOS

ESCAMAS

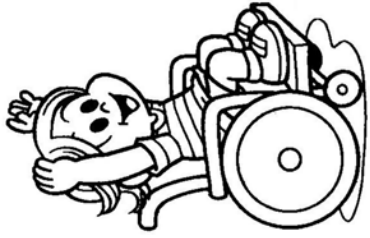

LUCA

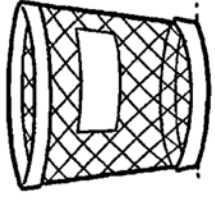
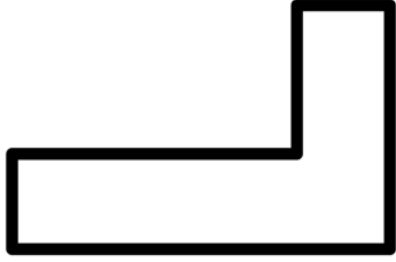

LIXO

VAMOS COBRIR O PONTILHADO:

--	--

VAMOS, AGORA, COMPLETAR AS PALAVRAS:

	LATA
	LATA

	ÁPIS
	LAPIS

	LEITE
	LEITE

QUAIS PALAVRAS COMEÇAM COM A LETRA L?

VAMOS PINTAR AS FICHAS!

	LEÃO
--	------

	BALDE
--	-------

	GAVETA
--	--------

	LIVRO
--	-------

ALIMENTAÇÃO SAUDÁVEL







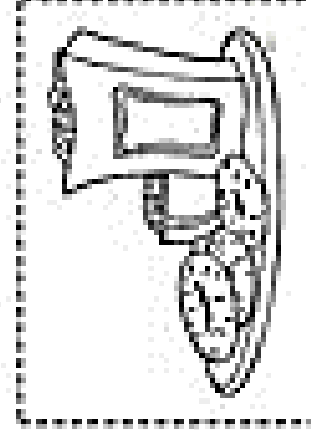
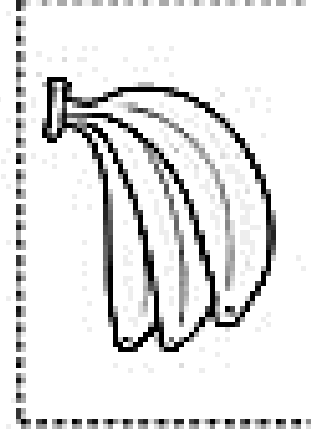
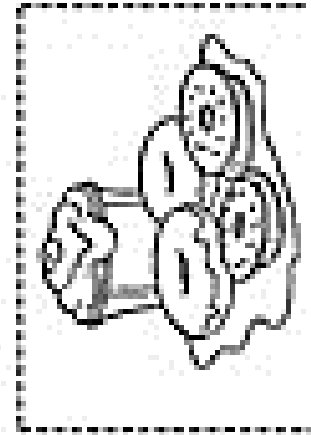
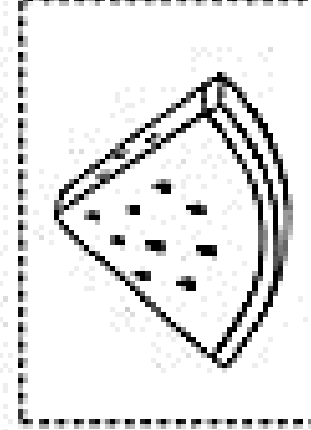
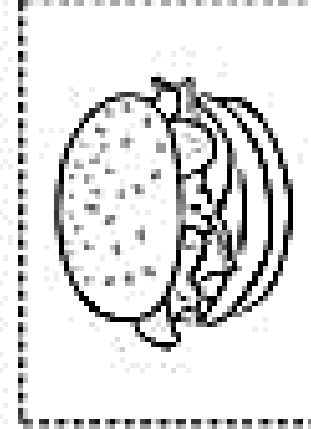
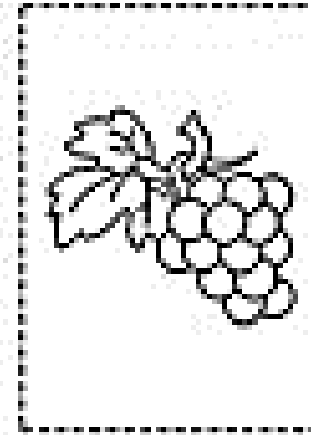









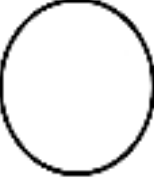

RECORTE E COLE AS FRUTAS NO LOCAL CORRETO:

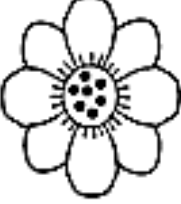





Pinte a figura diferente em cada sentença

NOME: _____

- DATA: _____

Atividade – Data: 29/10/2021

BRINCADEIRA: JOGO DO SÉRIO



NO JOGO DO SÉRIO, É PRECISO CONTER AS RISADAS.

QUERIDA FAMÍLIA, EM DUPLAS COM A CRIANÇA, UM DE FRENTE PARA O OUTRO, TENDE FAZER A OUTRA PESSOA RIR MANTENDO-SE SÉRIA. VALE FAZER CARETAS PARA TENTAR DESCONCENTRAR O OUTRO PARTICIPANTE.

GANHA QUEM CONSEGUIR SE MANTER SÉRIO MESMO DEPOIS DE TER FEITO TANTA PALHAÇADA.

NOME: _____ - DATA: _____

COMPLETE AS PALAVRAS COM A CONSOANTE L.

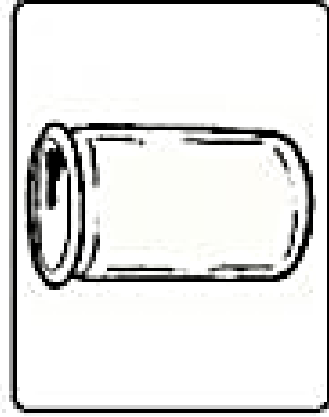

__ATA

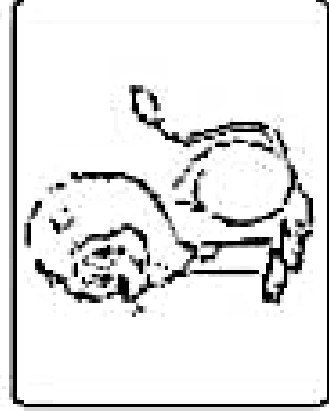

__EÃO

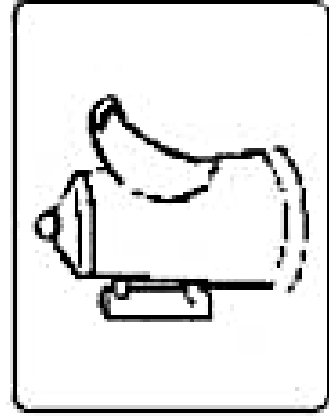

BU__E

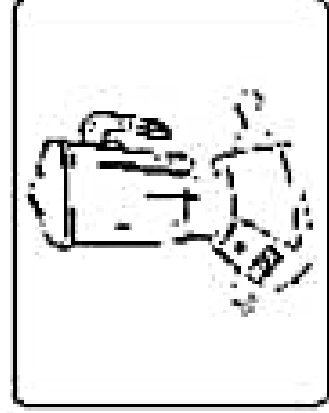

__IQUIDIFICADOR

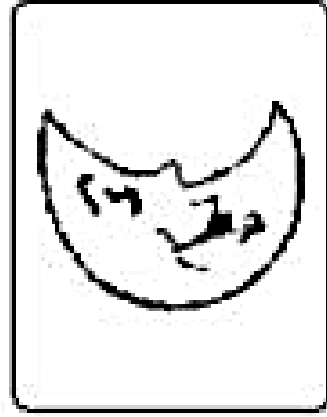

__UA

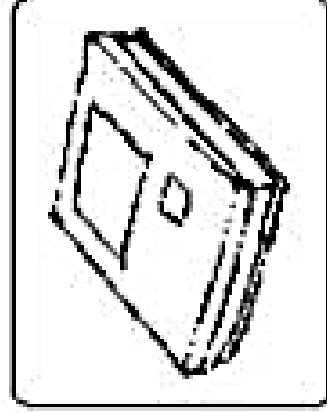

__IVRO

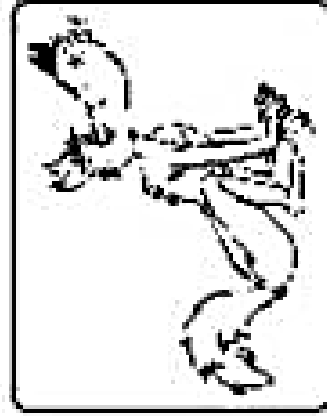

__OBO

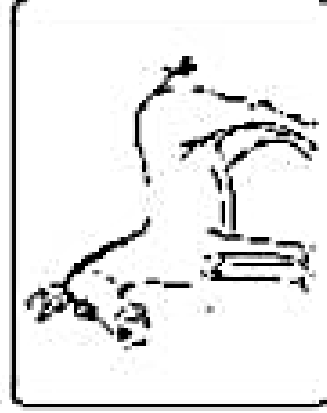

MU__A

Atividade – Data: 04/11/2021

QUERIDA FAMÍLIA, AUXILIE A CRIANÇA NESTA ATIVIDADE, EXPLICANDO QUE TRANSPORTE AÉREO ANDA NO AR, TRANSPORTE TERRESTRE ANDA NA TERRA E TRANSPORTE AQUÁTICO ANDA NA ÁGUA.

1-SEGUNDO A LEGENDA, CLASSIFIQUE OS MEIOS DE TRANSPORTE DE ACORDO COM O NUMERAL CORRESPONDENTE

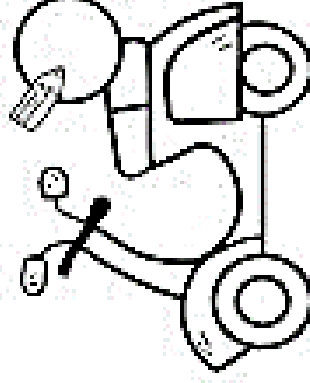
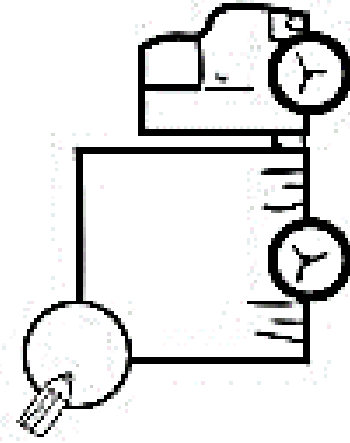
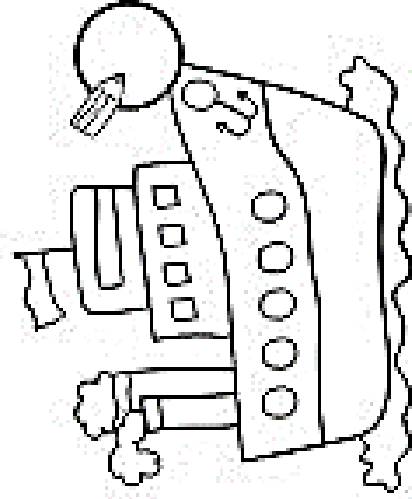
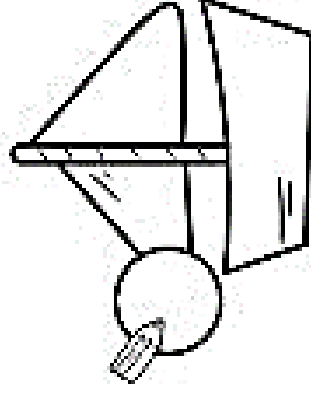
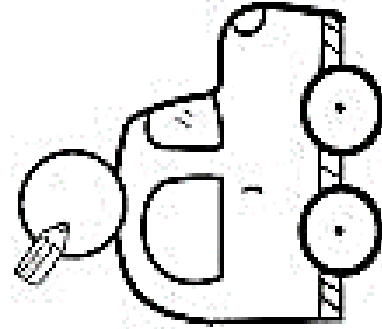
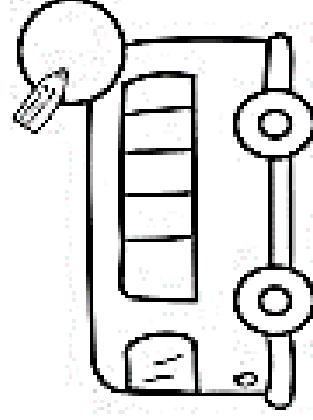
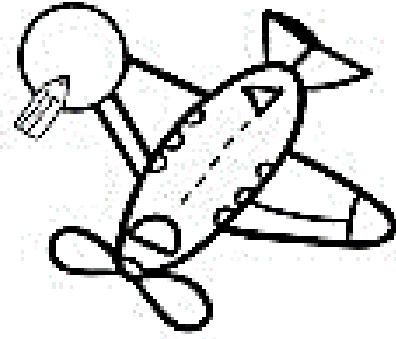
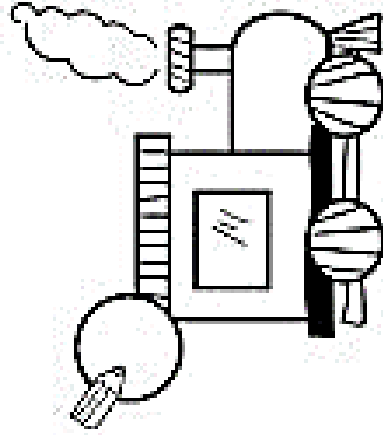

Encontre e circule as 5 diferenças

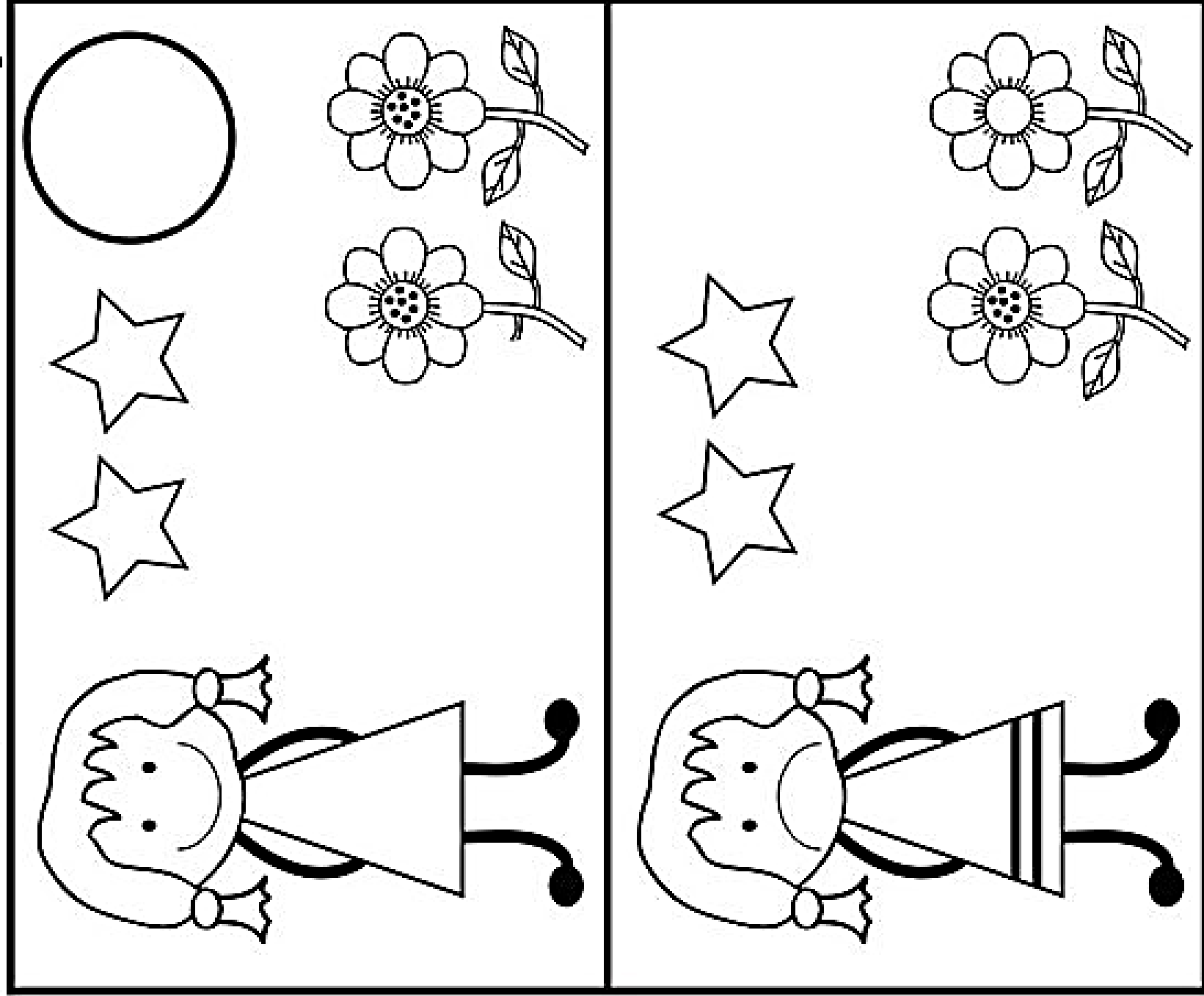

NOME: _____

- DATA: _____

FONTES:

- Capa - <https://amordepapeis.com.br/desenho-dia-das-criancas-para-colorir/> - ACESSO DIA: 03/10/2021;
- 1 - <https://israelakotona.blogspot.com/2020/11/calendario-turma-da-monica.html> - ACESSO DIA: 03/10/2021;
- 1 - <https://israelakotona.blogspot.com/2020/11/calendario-2021-patrolha-canina.html> - ACESSO DIA: 03/10/2021;
- 2 - http://3.bp.blogspot.com/-Gc_tu2cCalo/Tb8HxmmJgRI/AAAAAAAAAgkw/hj2S2ldOLrs/s1600/LETRA+K.png - ACESSO DIA: 03/10/2021;
- 3 - <https://escolaeducacao.com.br/atividade-dia-do-transito-para-educacao-infantil/atividade-dia-do-transito-para-imprimir/> - ACESSO DIA: 03/10/2021;
- 3 - <https://www.youtube.com/watch?v=kIzkRjTZjhE> - ACESSO DIA: 03/10/2021;;
- 4 - <https://br.pinterest.com/pin/733453489284740968/> - ACESSO DIA: 03/10/2021;
- 5 - <https://atividadesparaprofessores.com.br/25-atividades-de-alfabetizacao-com-a-letra-k/> - ACESSO DIA: 03/10/2021;
- 6 - <https://imagensemoldes.com.br/atividade-de-educacao-infantil-1o-ano-ciencias-cobertura-corpo-dos-animais/> - ACESSO DIA: 03/10/2021;
- 7 - <http://4.bp.blogspot.com/-ZI2j-8aDSXg/Tb8H0GRRv9I/AAAAAAAAAgk0/9FsPXC4Buyw/s1600/LETRA+L.png> - ACESSO DIA: 03/10/2021;
- 8 - <https://www.mestredosaber.com.br/wp-content/uploads/atividades-com-frutas2.jpg> - ACESSO DIA: 03/10/2021;
- 9 - <https://br.pinterest.com/pin/573294227544470377/> - ACESSO DIA: 03/10/2021;
- 10 - <https://www.todamateria.com.br/jogos-populares/> – ACESSO DIA: 03/10/21;
- 11 - <http://www.professorzezinhoramos.com/2013/06/atividades-com-letra-l.html> - ACESSO DIA: 03/10/21;
- 12 - <https://br.pinterest.com/pin/66920744451811138/> - ACESSO DIA: 03/10/21;
- 13 - <https://br.pinterest.com/pin/53550683054323321/> - ACESSO DIA: 03/10/21;