

Atividades Remotas 13

Escola: E.M Criança Feliz "Profª. Vitória Evany Miguel Cordeiro"



**FELIZ
DIA DAS
CRIANÇAS**

Nome: _____ - Fase II - D

(Professora: Vânia Maria Rodrigues)

Data de Entrega: 08/11/2021

(Período: 18/10/21 a 05/11/21).

Senhores Pais ou Responsáveis

Devido a pandemia do covid-19 (Coronavírus), que atinge o mundo nesse momento, foi necessárias adaptações para que os alunos continuem com a aprendizagem em casa, e o papel da família será de suma importância, segue aqui nessa apostila atividades datadas que se possível deverão ser realizadas no respectivo dia da reposição.

Atenção

Orientações Gerais para a realização das atividades.

- ✓ As atividades estão datadas;
- ✓ Realizar a leitura de todas as atividades junto com a criança;
- ✓ Explicar ao aluno o que será necessário ser feito, cada atividade traz orientações de como serem realizadas;
- ✓ Solicitar aos alunos que realizem a pintura bem caprichada dos desenhos, inclusive da capa;
- ✓ Na medida do possível registrar com fotos ou vídeos e enviar no grupo da sala, pelo WhatsApp;
- ✓ Pedimos a gentileza de cuidarem dessas atividades, pois as mesmas terão que ser devolvidas;
- ✓ É muito importante o treino e escrita do nome e data em todas as atividades solicitadas, evitando assim dificuldades futuras.

Aqui deixamos nosso agradecimento e admiração por cada família, pelo empenho e esforço realizado em casa.

Qualquer dúvida, estou à disposição!

Atenciosamente, Prof^ª. Vânia.

NA ESCOLA, JÁ ERA ROTINA AS CRIANÇAS APRENDEREM SOBRE DIA, SEMANA E MÊS, SEGUE O CALENDÁRIO DO MÊS DE OUTUBRO E NOVEMBRO, PARA QUE OS DIAS SEJAM COLORIDOS DE ACORDO COM A DATA DE CADA ATIVIDADE.



CALENDÁRIO
2021

DATAS COMEMORATIVAS DO MÊS 

12- PADROEIRA DO BRASIL

OUTUBRO

DOM	SEG	TER	QUA	QUI	SEX	SAB
17	18	19	20	21	22	23
24	25	26	27	28	29	30
31						



CALENDÁRIO
2021

NOVEMBRO

DATAS COMEMORATIVAS DO MÊS 

02 – FINADOS 15 PROCLAMAÇÃO DA REPÚBLICA
20 – CONSCIÊNCIA NEGRA

DOM	SEG	TER	QUA	QUI	SEX	SAB
	1	2	3	4	5	6

NOME: _____ - DATA: _____



KEIKA

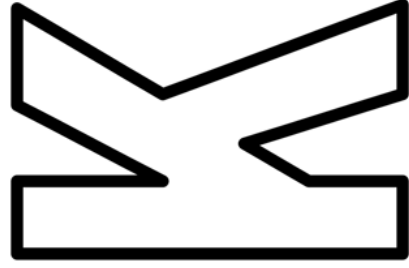

KIBON

VAMOS COBRIR O PONTILHADO:



VAMOS, AGORA, COMPLETAR AS PALAVRAS:

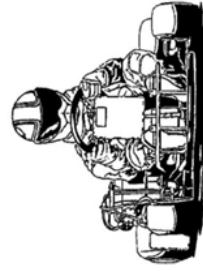

KART

KART

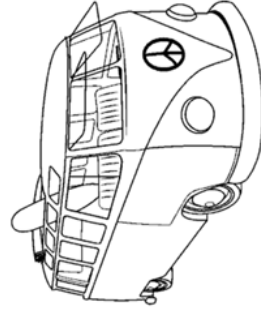

KOMBI

KOMBI



KINDER

KINDER

QUAIS PALAVRAS COMEÇAM COM A LETRA K?

VAMOS PINTAR AS FICHAS!



KUAT

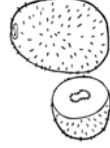

KIWI



MALA

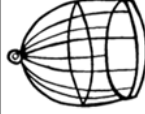

GAIOLA

Atividade – Data: 20/10/2021

ANTES DE REALIZAR A ATIVIDADE, ASSISTIR O VÍDEO.

SUGESTÃO DE VÍDEO: https://www.youtube.com/watch?v=uxn8l_dIELA

Música: O SEMÁFORO (TURMA DO PAMBOLÉ)/semana do trânsito Educação infantil

OBSERVE AS DUAS ATITUDES DOS PEDESTRES E PINTE APENAS A QUE ESTIVER CORRETA:

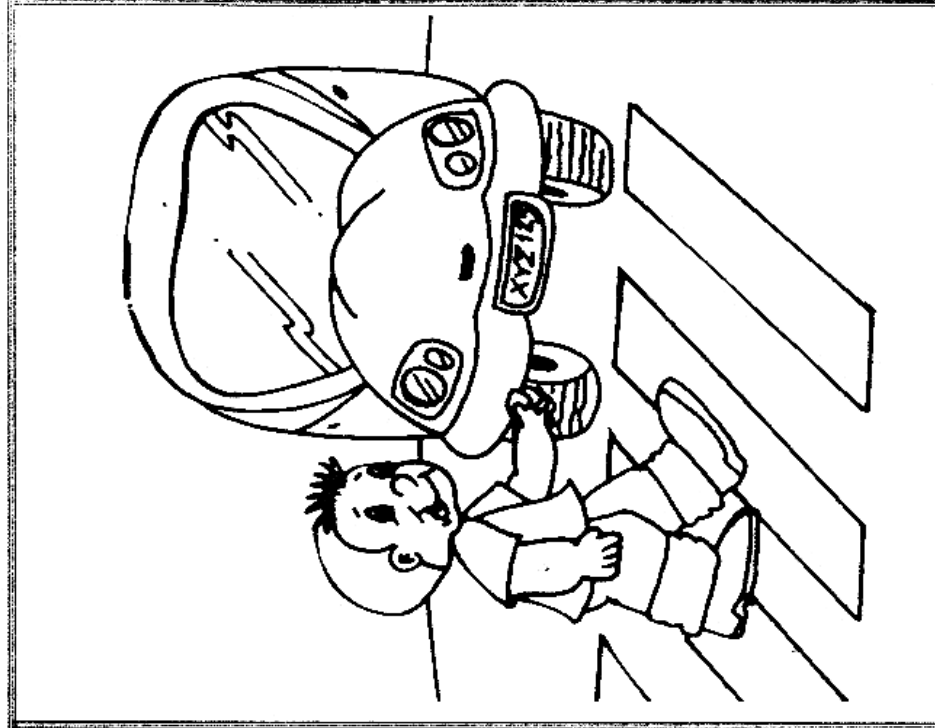
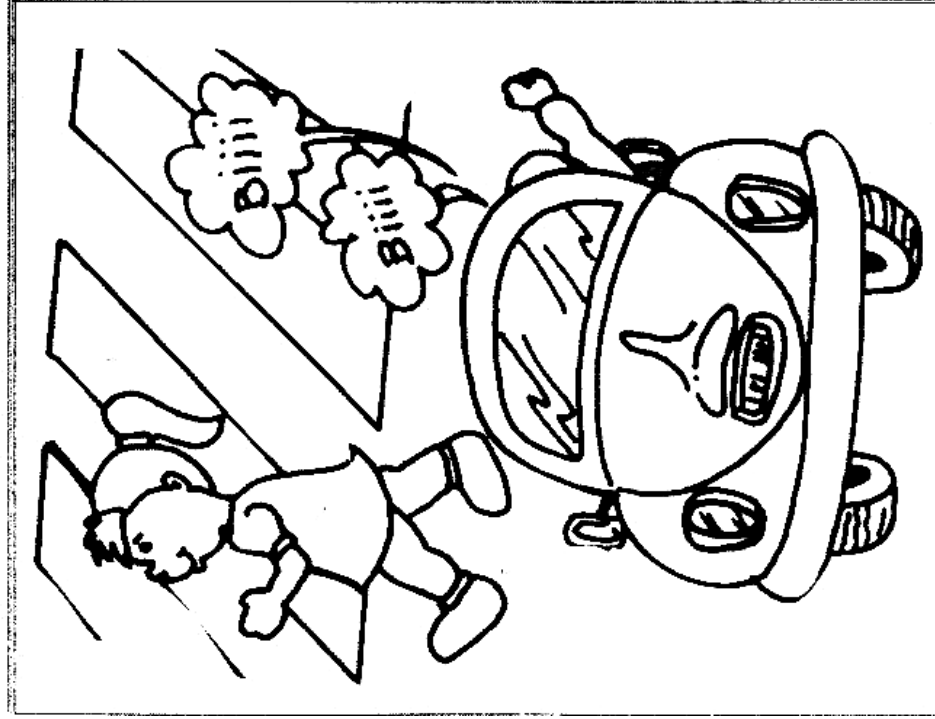

AGORA, VAMOS PINTAR O SEMÁFORO E SEU SIGNIFICADO DE ACORDO COM A LEGENDA?

PARE!

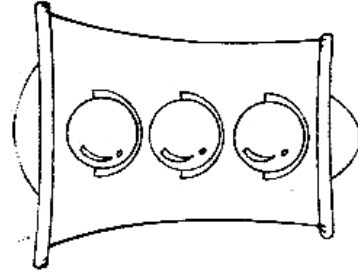

VERMELHO

ATENÇÃO!

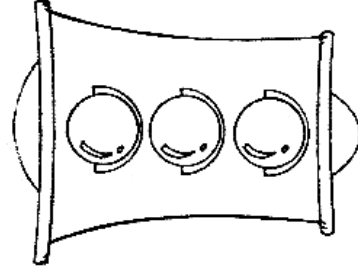

AMARELO

SIGA!

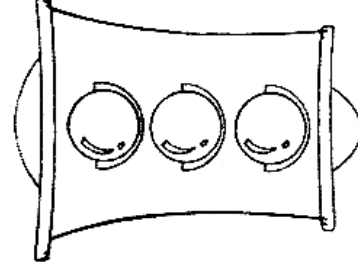

VERDE

Atividade – Data: 21/10/2021

1- LEVE ATÉ A MÃO DO URSINHO O BALÃO COM A QUANTIDADE DE BOLINHAS CORRESPONDENTE AO NUMERAL INDICADO EM SUA BARRIGA.

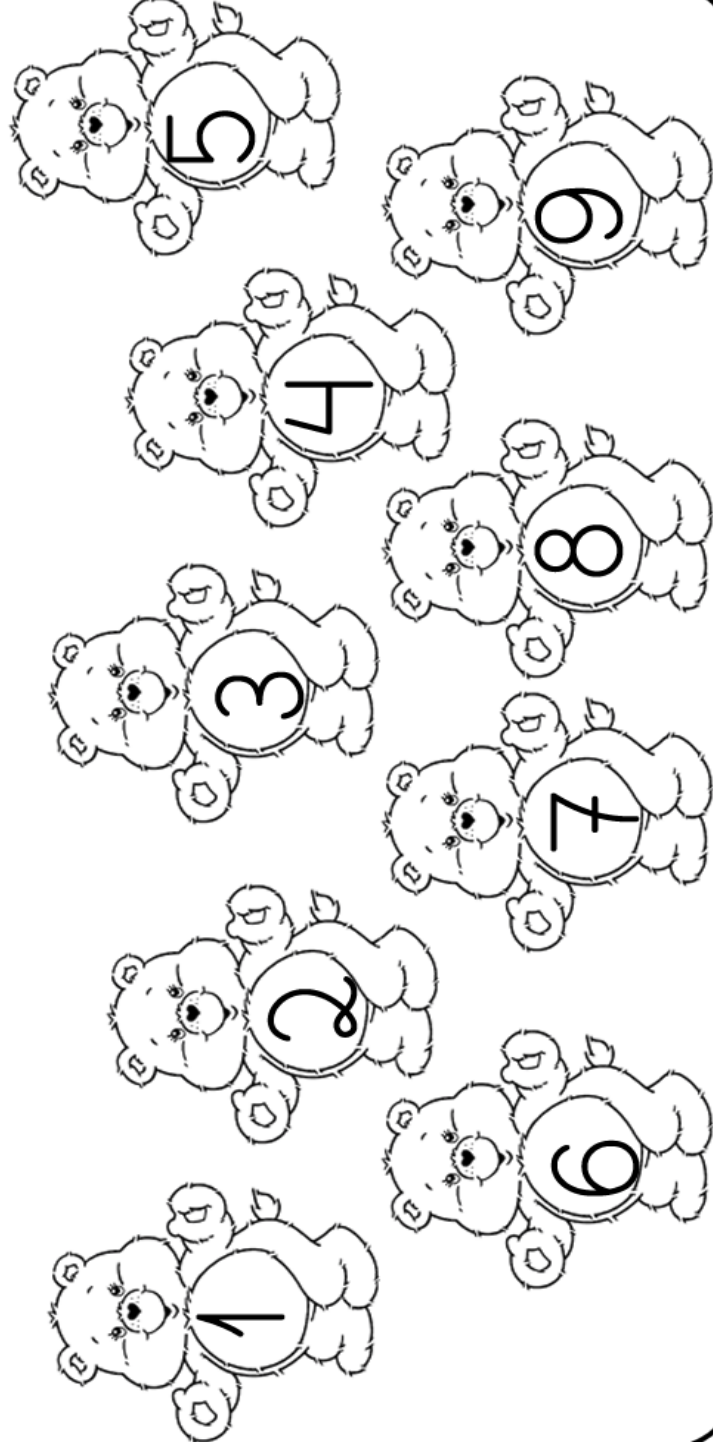
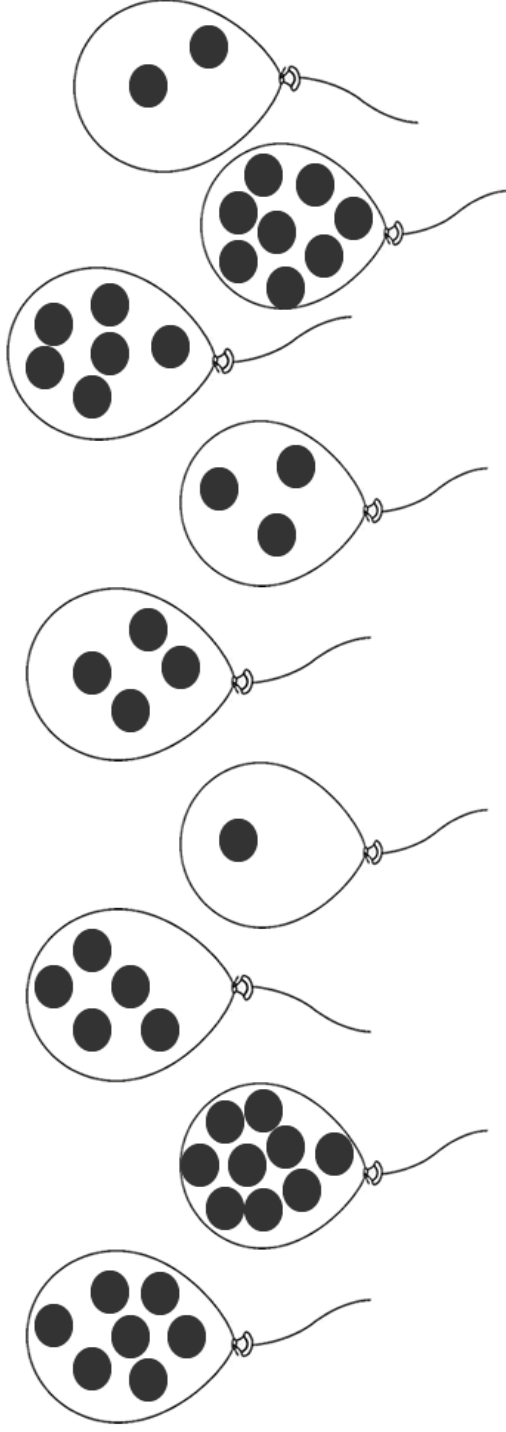

NOME: _____

- DATA: _____

PINTE OS QUADROS QUE TENHAM PALAVRAS
ESCRITAS COM A LETRA **K**.

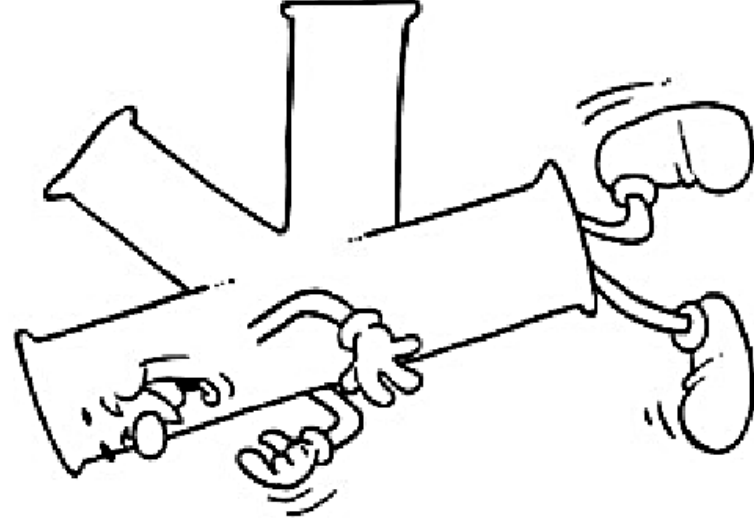

BOCA

KIWI

KARINA

CORAÇÃO

KETCHUP

KÁTIA

KARAOKE

COMETA

KART

KIBOM

CAIO

KLÉBER

NOME: _____

- DATA: _____

QUANTAS PATAS TEM?

QUANTAS PATAS TEM CADA ANIMAL?

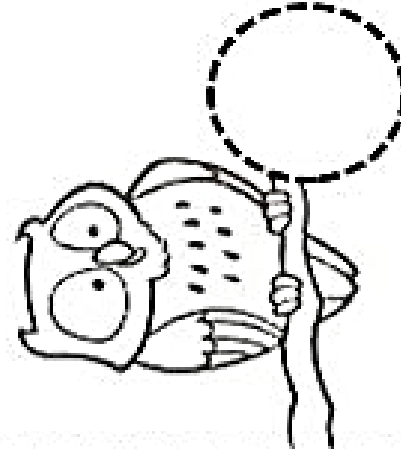
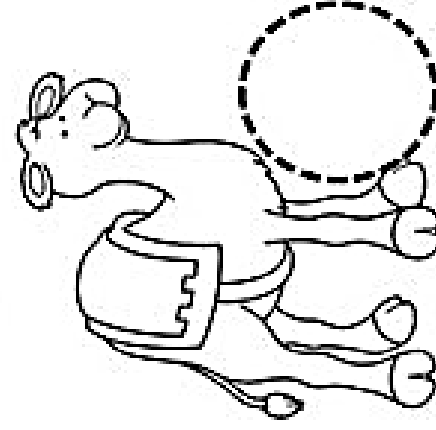
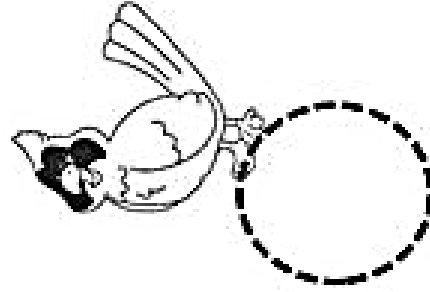
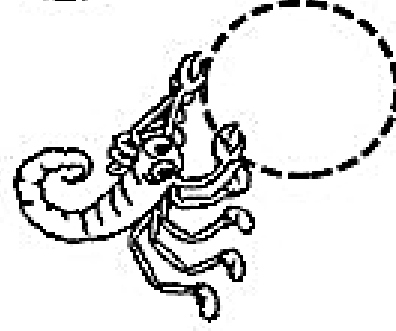
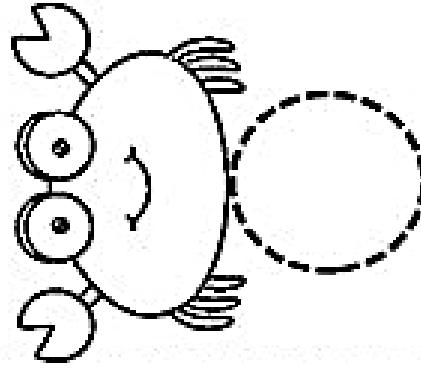
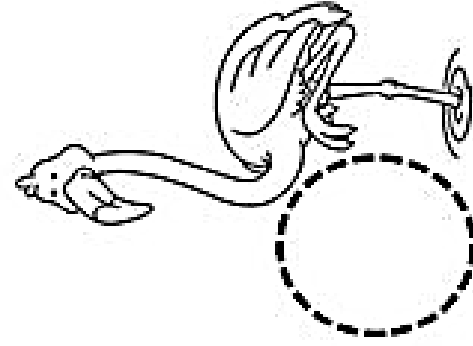
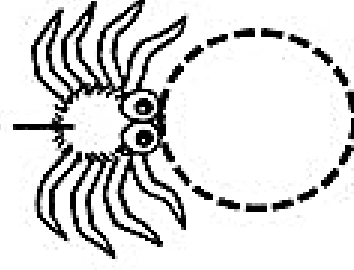
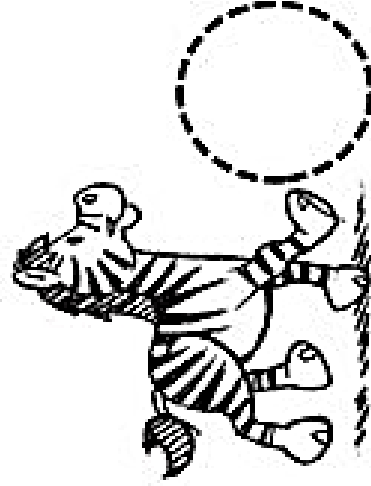
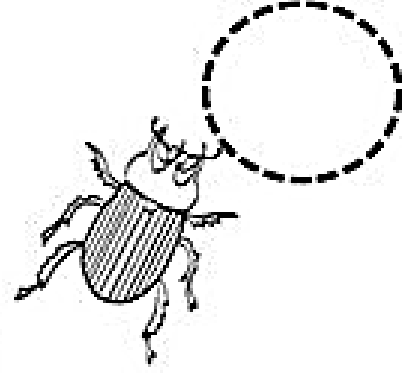
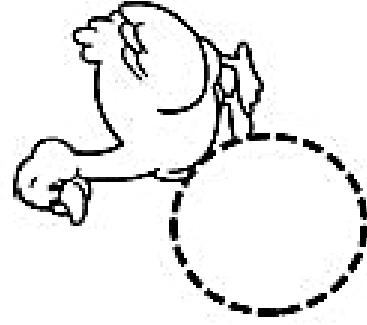
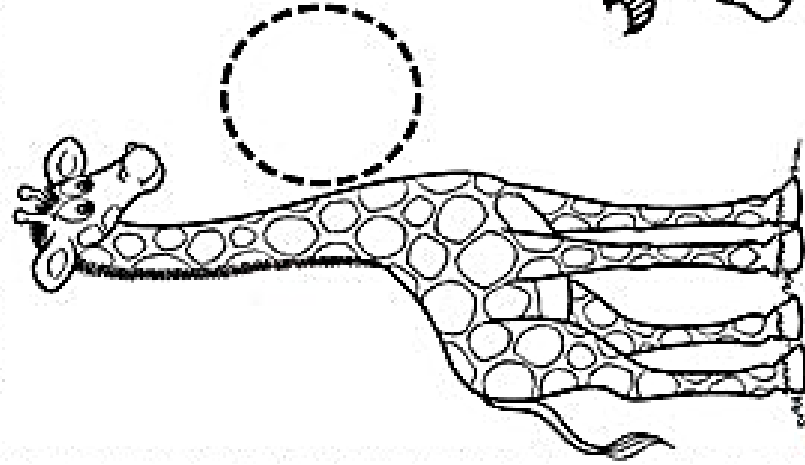

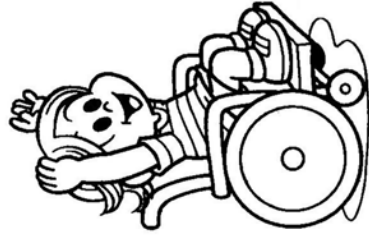

LUCA

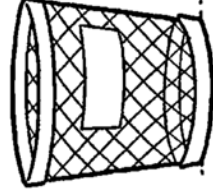

LIXO

VAMOS COBRIR O PONTILHADO:

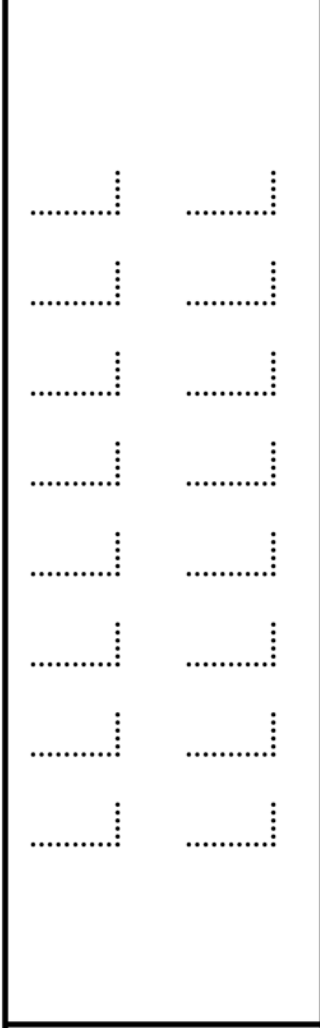
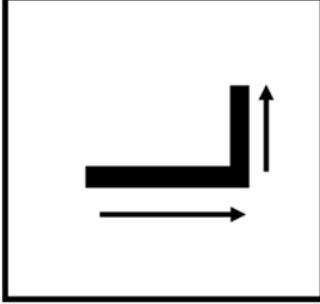

VAMOS, AGORA, COMPLETAR AS PALAVRAS:

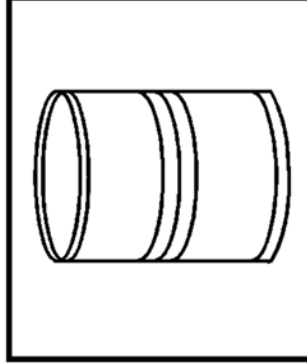

LATA

LATA

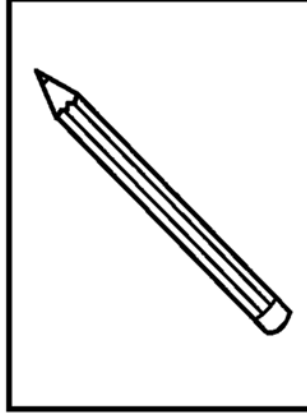

LÁPIS

LÁPIS

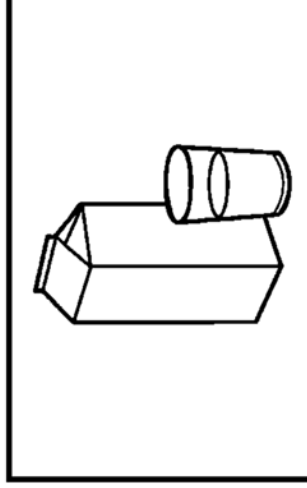

LEITE

LEITE

QUAIS PALAVRAS COMEÇAM COM A LETRA L?

VAMOS PINTAR AS FICHAS!



LEÃO



BALDE



GAVETA



LIVRO

PINTE OS ALIMENTOS DE QUE VOCÊ MAIS GOSTA.

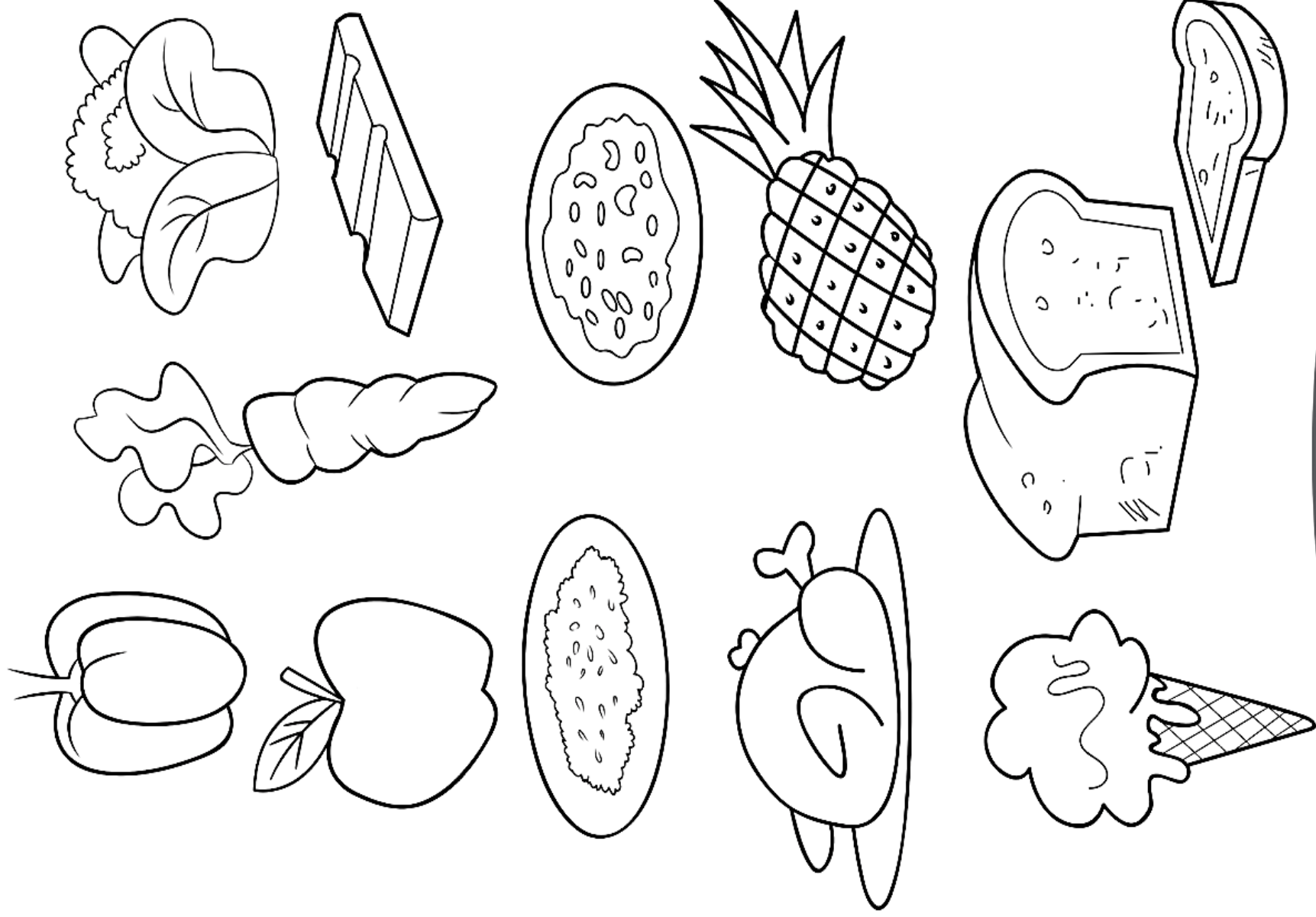

NOME: _____

- DATA: _____

ATIVIDADE COORDENAÇÃO MOTORA- EDUCAÇÃO INFANTIL

Leve os passarinhos até a casinha usando lápis colorido

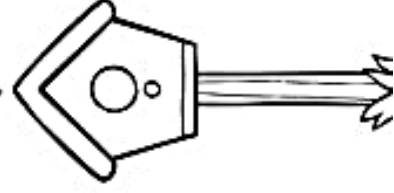
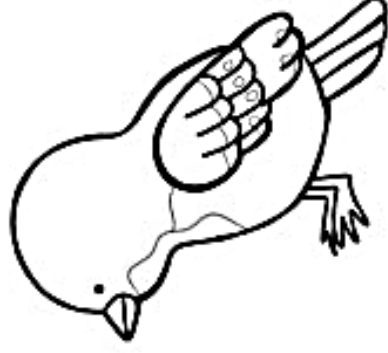
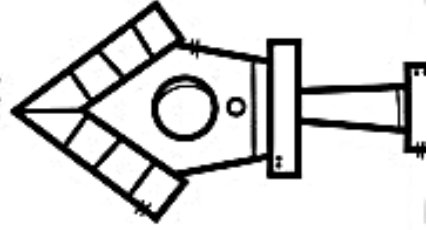
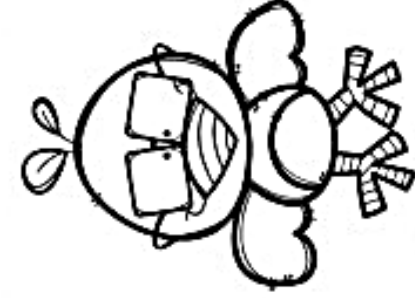
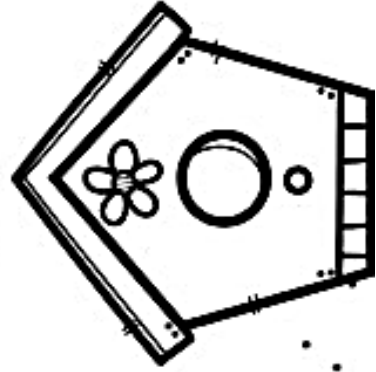
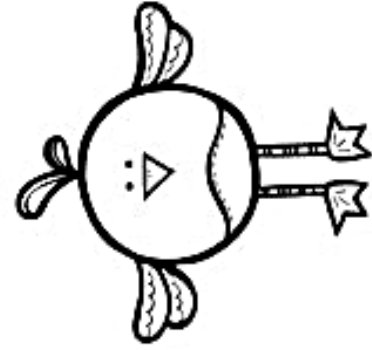

Atividade – Data: 29/10/2021

BRINCADEIRA: PROJEÇÃO DE SOMBRAS

QUE TAL BRINCAR DE PROJETER SOMBRAS NA PAREDE, UTILIZANDO AS MÃOS OU DIFERENTES MATERIAIS PARA CRIAR SILHUETAS? VOCÊ PODE DESAFIAR A CRIANÇA A FAZER SOMBRAS GRANDES, PEQUENAS, DE FORMATOS DIFERENTES E PEDIR PARA QUE ELA AS DESCREVA: “O QUE É ESSA SOMBRA? ”, “É GRANDE? ”, “É PEQUENA? ”, “É UM ANIMAL? QUAL? ”.



NOME: _____ - DATA: _____

PINTE OS DESENHOS QUE COMEÇAM COM A

LETRA **L**



LEITÃO



LUA

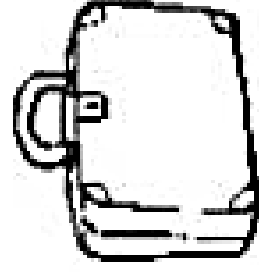

MALA

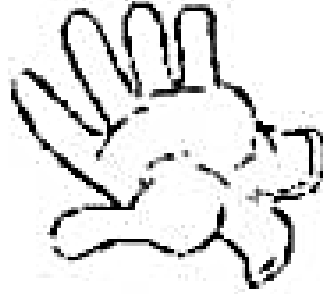

LUVA

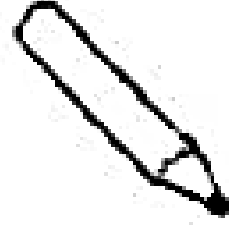

LÁPIS



GOLA

PINTE AS PALAVRAS QUE TENHAM A SILABA **LA** .

LARANJA

MOLA

LIMÃO

LEITE

LIVRO

LEQUE

GAIOLA

BALA

Atividade – Data: 04/11/2021

QUERIDA FAMÍLIA, AUXILIE A CRIANÇA NESTA ATIVIDADE, EXPLICANDO QUE TRANSPORTE AÉREO ANDA NO AR, TRANSPORTE TERRESTRE ANDA NA TERRA E TRANSPORTE AQUÁTICO ANDA NA ÁGUA.

CIRCULE OS MEIOS DE TRANSPORTE AÉREOS E RISQUE OS MEIOS DE TRANSPORTE TERRESTRES.

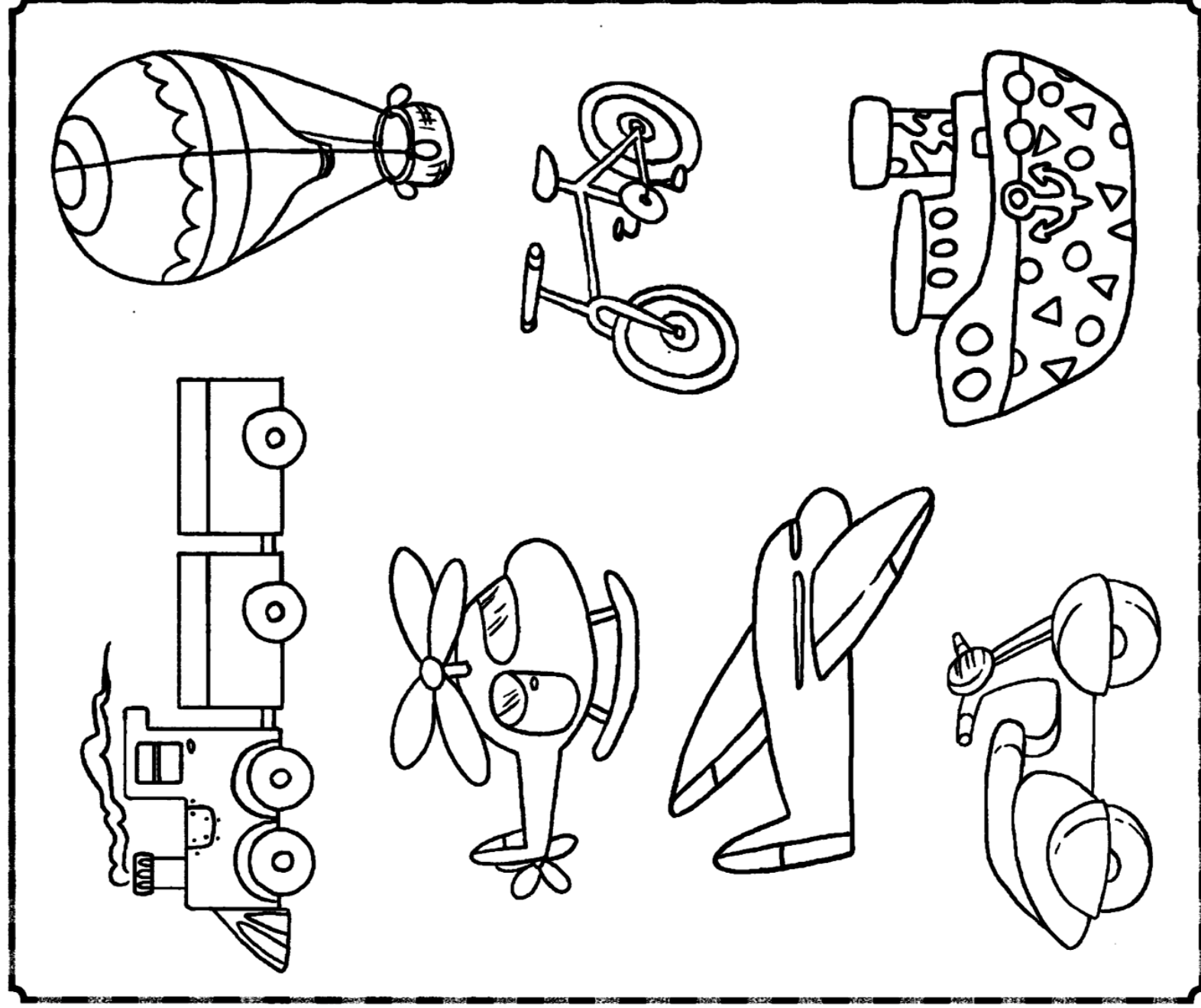

ONDE ESTÁ A DIFERENÇA?

1- PROCURE AS 4 DIFERENÇAS ENTRE AS IMAGENS.

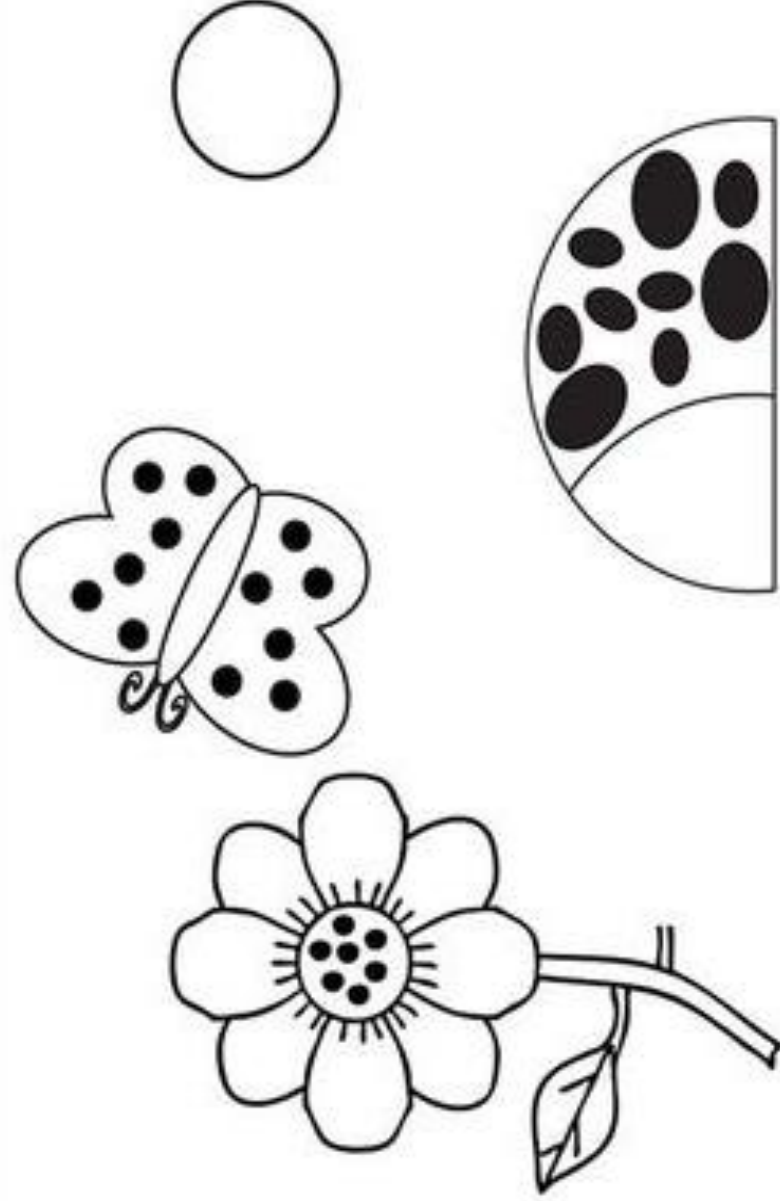
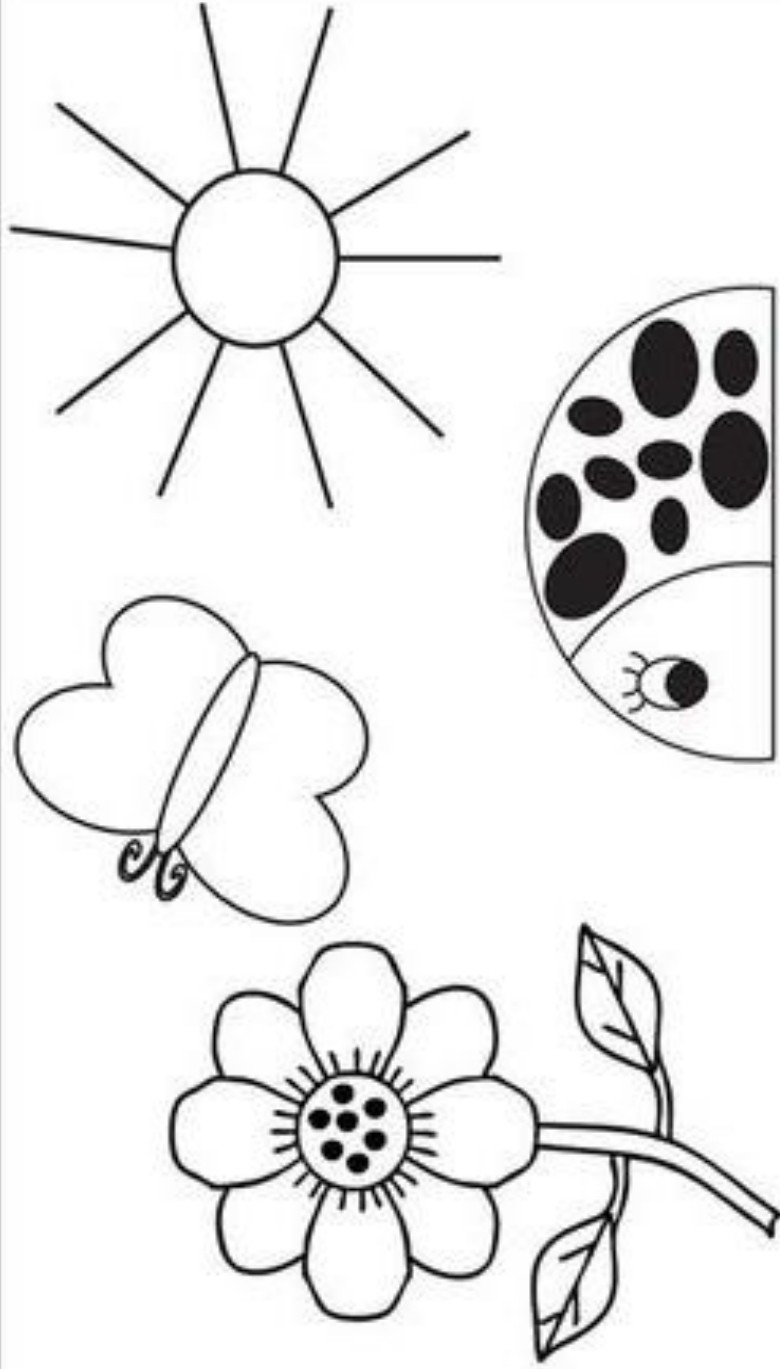

FONTES:

- Capa - <https://amordepapeis.com.br/atividade-pintura-dia-das-criancas/> - ACESSO DIA: 03/10/2021;
- 1 - <https://br.pinterest.com/pin/498632989999508697/> - ACESSO DIA: 03/10/2021;
- 1 - <https://israelakotona.blogspot.com/2020/11/calendario-turma-da-monica.html> - ACESSO DIA: 03/10/2021;
- 2 - http://3.bp.blogspot.com/-Gc_tu2cCalo/Tb8HxmmJgRI/AAAAAAAAAgkw/hj2S2ldOLrs/s1600/LETRA+K.png - ACESSO DIA: 03/10/2021;
- 3 - <https://www.espacoeducar.net/2014/09/projeto-transito-para-educacao-infantil.html> - ACESSO DIA: 03/10/2021;
- 3 - https://www.youtube.com/watch?v=uxn8l_dIELA - ACESSO DIA: 03/10/2021;;
- 4 - <https://1.bp.blogspot.com/-aznjSW6L7Wc/V0t4qcokw1I/AAAAAAAAAe3c/Hk4SKVZuPWEhK0NettN4WoPnyBeIcL5QQCLcB/s1600/QUANTIDADES.png> - ACESSO DIA: 03/10/2021;
- 5 - <https://www.educacaoetransformacao.com.br/wp-content/uploads/2018/04/atividades-com-a-letra-k-pinte-o-quadrado.png> - ACESSO DIA: 03/10/2021;
- 6 - <https://br.pinterest.com/pin/569212840388824459/> - ACESSO DIA: 03/10/2021;
- 7 - <http://4.bp.blogspot.com/-ZI2j-8aDSXg/Tb8H0GRRv9I/AAAAAAAAAgk0/9FsPXC4Buyw/s1600/LETRA+L.png> - ACESSO DIA: 03/10/2021;
- 8 - <http://novojeitodeensinar.blogspot.com/2015/01/colecao-amarelinha-natureza-e-sociedade.html> - ACESSO DIA: 03/10/2021;
- 9 - <https://www.clickseducativos.com.br/atividades-de-coordenacao-motora-fina/> - ACESSO DIA: 03/10/2021;
- 10 - <https://labedu.org.br/brincar-com-sombras/> - ACESSO DIA: 23/09/2021;
- 10 - <https://lunetas.com.br/brincadeiras-criativas-o-potencial-ludico-das-sombras/> - ACESSO DIA: 23/09/2021;
- 11 - <http://www.professorzezinhoramos.com/2013/06/atividades-com-letra-l.html> - ACESSO DIA: 03/10/2021;
- 12 - <https://soatividades.com/wp-content/plugins/sa-custom/pdf/new.php> - ACESSO DIA: 03/10/2021;
- 13 - <https://br.pinterest.com/pin/86553624078661590/> - ACESSO DIA: 03/10/2021;